

# **MBTA Guide to Access**

Guidelines for Designing Barrier-Free  
Transportation Facilities

prepared for  
**Massachusetts Bay Transportation Authority**  
Thomas P. Glynn, General Manager  
Peter F. McNulty, Director of Construction

by  
**Adaptive Environments Center**  
October 1990



**MASSACHUSETTS  
BAY  
TRANSPORTATION  
AUTHORITY**

Thomas P. Glynn  
*General Manager*  
Transportation Building  
Ten Park Plaza  
Boston, Massachusetts 02116

Dear Design Professional

Access is a civil right. That principle, which has already shaped how the MBTA designs and operates its system, is now also clearly stated in law. The Americans with Disabilities Act, passed into law during the summer of 1990, joins Massachusetts law in ensuring access to all of our system and will surely increase the awareness of, and demand for, that access.

Good access is also good design. Stations that are safe, convenient and pleasant to use, for all our passengers, is the obvious goal whether one is designing and building a new station or renovating one of the oldest transit stations in the country.

As these guidelines make clear, access features help produce stations that are more "user friendly," not only for those with disabilities but also for parents with children, for infrequent users of the system and, at some time or another, for most every rider of the T.

Good access is an integral part of the T's commitment to customer service. This is why you will find in this volume, along with how, where and when to meet minimal state and federal access code requirements, guidance on how to broaden and enhance access so that using the T can become as natural and important source of transportation for disabled customers as for our other 660,000 daily riders.

In publishing these guidelines for access, a first in the transit industry, the MBTA makes this commitment: America's oldest transit system will soon be one of the most accessible. We look forward to working with you toward this goal.

Sincerely,

Thomas P. Glynn  
General Manager

# TABLE OF CONTENTS

---

<b>1</b>	<b>Introduction</b>	<b>Introduction</b>	<b>1</b>
		Who Benefits from Accessible MBTA Stations	
		Who the Guide is For	
		What's in the Guide	
		How the Guide is Organized	
		Public and Employee Areas	
<b>2</b>	<b>Access to MBTA Stations</b>	<b>Disabilities and Design</b>	<b>7</b>
		Who Am I Designing For	
		Labels and Expectations	
		Everyone Benefits	
		<b>Designing for Functional Limitations</b>	<b>10</b>
		<b>Accessibility and the Law</b>	<b>12</b>
		Federal Laws and Regulations	
		Federal Variance Procedures	
		State Laws and Regulations	
		Compliance	
Advisory Opinions			
State Variance Process			
Technical Assistance			
<b>3</b>	<b>Design of Transit System Elements</b>	<b>Site</b>	<b>21</b>
		Schematic Site Design	
		Parking	
		Passenger Loading Zone	
		Accessible Route	
		Curb Cuts	
		<b>Entrance</b>	<b>45</b>
		Schematic Entrance Design	
		Entrance	
		<b>Fare Collection</b>	<b>55</b>
Schematic Fare Collection Design			
Approach to Fare Collection			
Fare Collection Booth			
Accessible Gates			
Token, Ticket, and Change Machines			

---

# TABLE OF CONTENTS

---

<b>5</b>	<b>Maintaining Access</b>	<b>Maintaining Access</b>	<b>177</b>
		Parking Lots	
		Accessible Route to the Station	
		Entrance	
		Fare Collection	
		Elevators and Escalators	
		Telephones	
		Accessible Telephone Features	
		Platform Edge	
		Stairs	
		Floors	
		Lighting	
		Signs	
		Seasonal Maintenance	
		Construction	
		Cleaning	

---

<b>6</b>	<b>Design Review Checklist</b>	<b>How to Use the Checklist</b>	<b>185</b>
		<b>Design Review Checklist</b>	<b>186</b>

---

	<b>Appendix</b>	A - Glossary	
		B - New MAAB Regulations	
		C - International Symbol of Accessibility	

---

	<b>Index</b>	A - Photo and Illustration Credits	
		B - Index	

---

# 1

## INTRODUCTION

---

# Introduction

The MBTA is committed to providing a transit system accessible to all people. To accomplish that goal, the Massachusetts Bay Transportation Authority (MBTA) has commissioned this *MBTA Guide to Access* to provide assistance to consulting architects and engineers as well as to MBTA staff.

Everyone benefits from a barrier-free transit system because almost everyone experiences a disability at some time. In Massachusetts there are over 800,000 individuals who have a significant physical or sensory limitation. Many others are temporarily handicapped by illness, pregnancy, age, or injury. Parents pushing strollers or people carrying luggage also benefit from thoughtful, accessible design. Chances are that at some point in your life accessible design won't be for "them"—it will be for you.

Often we are unaware of who around us has a disability because the disability is not visible. We cannot "see" someone's arthritis, poor eyesight, hearing loss, or heart condition. Hence, many more people are in need of accessible design than one might think. Accessible design is much more than design for people using wheelchairs.

The number of people with disabilities who can participate in community life is increasing because of improved medical care and rehabilitation techniques, and increased longevity. More people with disabilities are living independently because living and working environments are finally being made accessible. Accessible public transportation plays a vital role in enabling people with disabilities to work and to participate fully in community life.

Architects, landscape architects, engineers, cost estimators, and contractors will find this book helpful because it defines the MBTA's expectations for a barrier-free transportation system. Development and construction staff at the MBTA and consumer review bodies can use the *Guide* to review projects and drawings for accessibility features.

**Who Benefits  
from  
Accessible  
MBTA  
Stations**

**Who the  
*Guide* is For**

---

**What's in  
the *Guide***

The *Guide to Access* is a reference manual for designing and operating heavy rail and commuter rail stations. Based on both state and federal regulations, the *Guide* references the Rules and Regulations of the Massachusetts Architectural Access Board (MAAB 1987) and the Uniform Federal Accessibility Standards (UFAS 1984). The *Guide* does not replace those regulations. Rather, it explains how and why the regulations must be met, and who benefits from their implementation.

In addition, there are some accessibility requirements in the *Guide* that have been issued by the MBTA. The intent of the MBTA's requirements is to encourage designers to move beyond simple code compliance and to thoroughly integrate barrier-free concepts into their design projects.

**Please note:** To keep this guidebook current, addenda will be issued by the MBTA as needed. Where changes or additions are anticipated, references to such addenda are made in the text. It is the obligation of the designer to utilize the most current version. It is also the obligation of the architect or engineer to conform to all applicable state and federal codes or regulations, whether or not they are identified in this document.

**How the  
*Guide* is  
Organized**

Chapter 3, "Design of Transit System Elements," covers design issues for heavy rail stations (Blue, Orange, and Red Lines). The chapter is organized to follow the order of the station elements as they would be encountered by commuters, from the exterior through the interior. For each area, schematic issues are presented first, followed by design details.

Although light rail stations are not specifically addressed in this guide, the principles described in Chapter 3 can be applied to the Green Line as well. Street-to-platform access requirements are the same for light rail stations as they are for heavy rail stations. When the issue of platform-to-car access for light rail stations is resolved, a light rail addendum will be added to this book.

In addition, although bus access is not covered directly, the principles outlined in the section "Site: Accessible Route" also apply to off-street busways.

---

Chapter 4, “Commuter Rail Station Access,” covers schematics and design issues unique to the commuter rail. Cross-references to Chapter 3 are provided for design issues which are common to both commuter rail and heavy rail subway stations.

Chapter 5, “Maintaining Access,” addresses common problems that arise once a building is in use, and discusses management and maintenance practices which sustain access by preventing the erosion of accessible features.

Chapter 6, “The Design Review Checklist,” is for use by station designers. It is structured to be used for reviewing drawings rather than for surveying a site. It is recommended that station designers consult the Checklist at the 30%, 60%, and 90% completion points. Compliance with this Checklist is required by the MBTA. Although we have attempted to make the Checklist comprehensive, circumstances may exist which the Checklist does not cover. The Checklist references the relevant code citations; however, any absences from the Checklist do not exempt station designers from those requirements.

Appendix A is a glossary of key terms used in this book.

Appendix B contains the text of the recent amendments to the MAAB code.

Appendix C provides a facsimile of the International Symbol of Accessibility, which may be copied and used.

Unlike the state access code, UFAS makes no distinction between public and employee areas. **UFAS requires accessibility in employee areas.** Exemptions are limited to areas such as elevator pits, elevator penthouses, mechanical rooms, piping or equipment catwalks, and electrical and telephone closets. For employee areas, apply the door and floor surface requirements in “Horizontal Circulation,” and the stair, ramp and elevator requirements in “Vertical Circulation.” Although it may not be possible to make every fare collection booth interior accessible, standards for an accessible booth are described in the “Fare Collection” section.

**Public and  
Employee  
Areas**



# 2

## ACCESS TO MBTA STATIONS

---

# Disabilities and Design

The physiology of people with disabilities varies as greatly as the physiology of the non-disabled population. There is no typical visually impaired person or wheelchair user. Attempts to compartmentalize people leave too many people in the “other” category.

**Who Am I  
Designing  
For?**

The quality of life for most people with disabilities can be significantly enhanced by better environmental design. Most recommendations in the Design chapters are accompanied by a description of who benefits from particular modifications and why. The discussion in this chapter seeks to broaden the scope of the designer’s question: *Who am I designing for?*

There are subtle, as well as not so subtle, characteristics associated with disabilities. Most people understand that someone using a wheelchair does not walk or walks only with great difficulty. What may not be apparent is that, depending on the etiology of the disability, someone who uses a wheelchair may or may not have manual dexterity, trunk balance, or bilateral strength. Someone who has had polio may retain full manual dexterity, while someone who has had an accident resulting in a spinal lesion may have limited control of his or her fingers. Such a person will benefit from easy-to-operate hardware as much as a person with arthritis, although this is perhaps not as obvious.

One of the most common misconceptions is that all visually impaired people cannot see at all, and that all hearing impaired people are completely deaf. Actually, there is a full range of hearing and visual impairments. And with a little forethought in the design, people’s usable sight and hearing can be maximally utilized.

---

**Labels and Expectations**

For a long time, the English language has been limited to the word “blind” to describe people who are visually impaired. This book uses the phrase “visually impaired” because “blind” is misleading. Most people with visual impairments do have some useful sight. The various effects of visual impairments can include diminished depth perception, reduced visual field, and sensitivity to glare.

Station designs can emphasize what many people are *able* to do. Many visually impaired people can read large print signs and video screens if they are able to get very close to the material. They may perceive the entrance of a building, but decals and contrasting colors help them to further distinguish a glass door from adjacent glass windows. A person who cannot see the first stair riser may be able to feel it along the handrail extensions.

Traditionally, people who are hearing impaired have been described as deaf. This is an imprecise way of referring to people with varying auditory abilities. A person who loses hearing as an adult may learn to speechread and retain the ability to easily converse in spoken English. For a person born deaf, spoken and written English are often secondary to American Sign Language. Both types of people benefit from information presented visually such as by simultaneous translation on monitor screens, closed captioning, sign language interpreters, and good signage.

People who have partial hearing can also benefit from good sound systems and assistive listening systems. These can aid comprehension because they not only amplify sound but also reduce background noise.

Many people who are disabled, especially those with sensory limitations, benefit from redundancy in the environment and in communication. Some people assimilate information more slowly, or in different sensory ways, than others, making repetition essential. Environmental cues should be repeated in different sensory modes. Examples of this are the audible station announcements on the train, the multiple visual signs throughout the station, and tactile signage.

---

A person with limited depth perception who can see color will rely on color to differentiate planes and establish navigational landmarks. Thoughtful use of color—differentiating doors from full-height windows at entrances, for example—builds more cues into the environment.

Besides having a range of abilities as diverse as that of the non-disabled population, many people with disabilities master a wide variety of skills in order to become as independent as possible. Some people who use motorized wheelchairs learn to maneuver the chair by use of a hand or mouth control. The motorized chair is usually turned like a car in a three-point, T-turn. Manual chairs are maneuvered differently. The rider can change directions by pivoting—moving the wheels in opposite directions simultaneously.

Over an average life span, almost everyone experiences both the development and loss of abilities. In a sense, children are disabled until they grow big enough to fit into the adult world and can reach stair railings, turn on lights, and see out of windows. Abilities also decline with age. Physical limitations can restrict people's activities and choices. Yet, in most cases, the physical environment, and not the disability, is the primary disabler.

**Everyone  
Benefits**

Environmental modification is critical if people are to be able to move around independently and with dignity. Designing our physical environment to be accessible to people of all abilities is particularly challenging because it requires a new definition of who uses buildings. Almost everyone, at some time, will personally discover the value of accessible design.

## Designing for Functional Limitations

The following are the most common functional limitations characteristic of disabilities. The etiologies listed are not exhaustive; rather, they are indicative of the range of illnesses, traumas, and congenital conditions which can cause a disability. A person who is disabled experiences some or all of the characteristics listed in the **Physiology** column. The **Environmental Needs** column lists some of the modifications which assist people with a particular limitation.

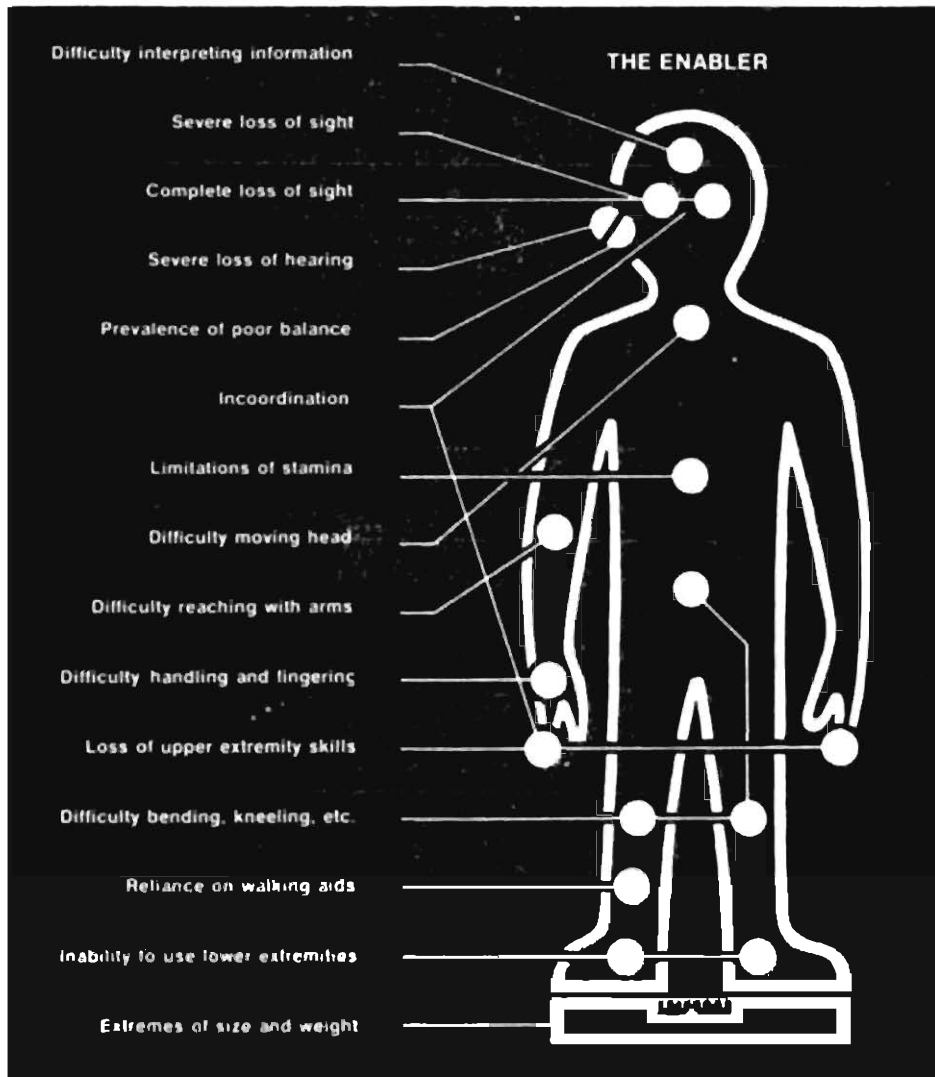

<b>Limitation</b>	<b>Etiology</b>	<b>Physiology</b>	<b>Environmental Needs</b>
<b>Sight</b>	Cataracts Congenital diabetes Trauma Retina degeneration	Cannot read small print Cannot focus Reduced depth perception Lacks central vision Lacks binocular vision Reduced visual field Increased sensitivity to light and glare Cannot see in dim light	Readable signage without glare Information in tactile form Information in audible form Cues to hazards Repetition of information
<b>Hearing</b>	Congenital disease Presbycusis Complications of other diseases	Cannot comprehend speech Comprehends speech only with amplification Speaks with difficulty Uses sign language or TDD to communicate	Information in visual form Amplification of speech, sound Interpretation of information Repetition of information
<b>Stamina</b>	Cardiac conditions Stroke Emphysema Hypertension Multiple sclerosis	Mild exertion results in shortness of breath and/or elevated blood pressure Tires easily due to nerve damage	Physical proximity of activities Energy-saving stairs, ramps, walks Places to rest Easily-obtained/assimilated information
<b>Lifting and Reaching</b>	Cerebral palsy Spinal cord injury Muscular dystrophy	Small limbs Limited rotational motion Limited muscular strength, control Limited flexibility Strength on only one side	Easily-operated hardware, controls Controls within reach Handrails on both sides
<b>Manual Dexterity</b>	Amputation Arthritis Severe burns Parkinson's disease Multiple sclerosis	Lack of sensation Limited rotational motion Limited flexibility Limited muscular control, strength Loss of thumb/digit opposability Strength on only one side	Easily-operated hardware, controls Handrails on both sides
<b>Mobility</b>	Spinal cord injury Cerebral palsy Spina bifida Stroke Amputation Aging Cancer Polio	Inability to walk Walks with difficulty Uses braces, crutches, cane, prothesis or walker Slow walker Ankle bending difficulty	Usable stairs, ramps, walks Physical proximity of activities Dimensional requirements of both manual and motorized wheelchairs Easily-obtained/assimilated information Places to rest
<b>Balance</b>	Inner ear disorder Spinal cord injury Multiple sclerosis Stroke	Difficult/impossible to maintain upright position either sitting or standing	Dimensional requirements of both manual and motorized wheelchairs Physical proximity of activities Handrails at level changes Usable stairs, ramps, walks

---

# Accessibility and the Law

The Uniform Federal Accessibility Standards (UFAS) and the state access requirements of the Massachusetts Architectural Accessibility Board (MAAB) both apply to MBTA stations. Where federal and state standards overlap, the stricter of the two takes precedence. In rare circumstances, when the standards are simply in conflict with each other, a judgment must be made. These guidelines have made recommendations based on which standard is more appropriate in a transportation setting and on what people in Massachusetts have come to expect.

Both UFAS and MAAB are referenced in the margin adjacent to the relevant text. When the requirements are the same, only one is listed. When the requirements differ, the stricter or the more appropriate one is listed.

Copies of UFAS may be obtained free of charge from the Architectural and Transportation Barriers Compliance Board (ATBCB), 1111 18th St. N.W., Suite 501, Washington, D.C. 20036-3894. The MAAB standard may be purchased from the State Bookstore, Room 116, State House, Boston, MA 02133.

## **Federal Laws and Regulations**

The most significant legislation is the Americans with Disabilities Act, a far-reaching, new antidiscrimination law passed in July 1990, which covers a wide range of public and private services and facilities including intercity rail, commuter rail, rapid transit service and fixed route buses. It insures that individuals are not prohibited from use of these key services by architectural, communication or policy barriers.

According to the provisions of ADA, all key stations must be accessible within three years of enactment. Regulations will be developed by the federal Department of Transportation within one year and guidelines for architectural, transportation and communications access will be developed by ATBCB. As new regulations and guidelines are promulgated, any necessary revisions to this book will be published as addenda.

---

Several other federal laws and related regulations on accessibility impact public transportation. They include the Architectural Barriers Act of 1968 (ABA); Section 504 of the Rehabilitation Act of 1973; and Section 16 of the Urban Mass Transportation Act of 1964.

The Architectural Barriers Act of 1968 (PL. 90-480) (ABA) ensures that elderly people and people with disabilities have access to public transportation facilities which receive federal funding for their construction. The design and construction standards for the ABA are the Uniform Federal Accessibility Standards (UFAS). Transit systems built after the 1968 Act are generally accessible to and safe for people with disabilities. Retrofitting existing stations are a particular challenge in older systems.

Section 504 of the Rehabilitation Act prohibits discrimination due to a handicapping condition and requires that all programs and services which receive federal funding be accessible to people with disabilities. Section 504 also requires the accessibility of buildings and facilities constructed by recipients of federal funds.

To reduce confusion between ABA and 504 coverage, the Department of Justice, which coordinates all Section 504 regulations, has issued a notice that UFAS should be used for all renovations required to provide either program or facility access.

There are four federal agencies which have set accessibility standards: the General Services Administration, the Departments of Housing and Urban Development and Defense, and the United States Postal Service. These four agencies have accepted the Uniform Federal Accessibility Standards (UFAS) published by the federal government in 1984 as the common standard. Transportation is included under the General Services Administration (GSA). To ensure that facilities designed, constructed, leased or altered with federal funds are in compliance with federal standards, Congress established the ATBCB. Transportation facilities are under the jurisdiction of the ATBCB.



---

UFAS was originally based on the technical provisions published by the American National Standards Institute A117.1 (ANSI) in 1980. The ANSI Standard, first issued in 1961, was the first nationally disseminated standard for handicapped accessibility. UFAS was published in the Federal Register on August 7, 1984. Since that time conforming revisions in both UFAS and ANSI have been made.

**Federal  
Variance  
Procedures**

MBTA approval is required prior to application for a variance. Requests for a variance in a transit facility must be sent *through* the Department of Transportation (DOT) to the Administrator of the General Services Administration (GSA). There is no standard application form. Rather, the architect must write a letter requesting a variance. The letter should ask the DOT to forward the request to the Administrator of the GSA.

The letter should describe the situation with as much relevant detail as possible. The GSA is interested in backup materials from structural engineers, historic preservation boards or others whose expertise or jurisdiction applies to the case. Photographs or annotated architectural drawings can also be useful. The letter should explain as clearly as possible why the requirement cannot be met *and* what accessibility provisions have been made. It is critical to demonstrate an intent to meet the spirit of the law within the limiting circumstances. In general, grounds for a variance include technical infeasibility or historic preservation rules. Expense does not usually constitute grounds for a variance. Sometimes the GSA Administrator will request more information from the architect. Architects should be prepared to document the case thoroughly.

Variance procedures are usually carried out through the mail and over the phone. Rarely does the GSA request a hearing.

**State Laws  
and  
Regulations**

The Massachusetts Architectural Access Board (MAAB) regulations are a formal part of the state building code. Like the Elevator Code, the Plumbing Code, and the Electrical Code, the MAAB Regulations have been published as a separate document.

---

Several other federal laws and related regulations on accessibility impact public transportation. They include the Architectural Barriers Act of 1968 (ABA); Section 504 of the Rehabilitation Act of 1973; and Section 16 of the Urban Mass Transportation Act of 1964.

The Architectural Barriers Act of 1968 (PL. 90-480) (ABA) ensures that elderly people and people with disabilities have access to public transportation facilities which receive federal funding for their construction. The design and construction standards for the ABA are the Uniform Federal Accessibility Standards (UFAS). Transit systems built after the 1968 Act are generally accessible to and safe for people with disabilities. Retrofitting existing stations are a particular challenge in older systems.

Section 504 of the Rehabilitation Act prohibits discrimination due to a handicapping condition and requires that all programs and services which receive federal funding be accessible to people with disabilities. Section 504 also requires the accessibility of buildings and facilities constructed by recipients of federal funds.

To reduce confusion between ABA and 504 coverage, the Department of Justice, which coordinates all Section 504 regulations, has issued a notice that UFAS should be used for all renovations required to provide either program or facility access.

There are four federal agencies which have set accessibility standards: the General Services Administration, the Departments of Housing and Urban Development and Defense, and the United States Postal Service. These four agencies have accepted the Uniform Federal Accessibility Standards (UFAS) published by the federal government in 1984 as the common standard. Transportation is included under the General Services Administration (GSA). To ensure that facilities designed, constructed, leased or altered with federal funds are in compliance with federal standards, Congress established the ATBCB. Transportation facilities are under the jurisdiction of the ATBCB.

---

UFAS was originally based on the technical provisions published by the American National Standards Institute A117.1 (ANSI) in 1980. The ANSI Standard, first issued in 1961, was the first nationally disseminated standard for handicapped accessibility. UFAS was published in the Federal Register on August 7, 1984. Since that time conforming revisions in both UFAS and ANSI have been made.

**Federal  
Variance  
Procedures**

MBTA approval is required prior to application for a variance. Requests for a variance in a transit facility must be sent *through* the Department of Transportation (DOT) to the Administrator of the General Services Administration (GSA). There is no standard application form. Rather, the architect must write a letter requesting a variance. The letter should ask the DOT to forward the request to the Administrator of the GSA.

The letter should describe the situation with as much relevant detail as possible. The GSA is interested in backup materials from structural engineers, historic preservation boards or others whose expertise or jurisdiction applies to the case. Photographs or annotated architectural drawings can also be useful. The letter should explain as clearly as possible why the requirement cannot be met *and* what accessibility provisions have been made. It is critical to demonstrate an intent to meet the spirit of the law within the limiting circumstances. In general, grounds for a variance include technical infeasibility or historic preservation rules. Expense does not usually constitute grounds for a variance. Sometimes the GSA Administrator will request more information from the architect. Architects should be prepared to document the case thoroughly.

Variance procedures are usually carried out through the mail and over the phone. Rarely does the GSA request a hearing.

**State Laws  
and  
Regulations**

The Massachusetts Architectural Access Board (MAAB) regulations are a formal part of the state building code. Like the Elevator Code, the Plumbing Code, and the Electrical Code, the MAAB Regulations have been published as a separate document.

---

Every **newly constructed** building in Massachusetts, MBTA stations included, must comply fully with the regulations. If a **renovation** project costs more than 5% of the replacement cost of the station, it is subject to the following requirements:

If the cost of the work amounts to LESS than 25% of the replacement cost of the station *and*:

- if the cost of the work is less than \$50,000, then only that portion of the work being performed must comply with the code; or
- if the cost of the work is \$50,000 or more, then the portion of the work being performed must comply with the code and an accessible entrance and toilet must be provided.

If the work being performed amounts to *more* than 25% of the replacement cost of the station, the entire facility must be brought into compliance with the regulations.

Even when work is divided into separate phases or projects, or when each phase has been issued a separate building permit, the total cost of work performed in a 24 month period must be added together to determine the applicability of the requirements above. Historic registered stations owned or protected by the state may be allowed some variances by the Board upon formal application.

The MAAB disseminates information about its regulations to architects, engineers, and building inspectors, and provides limited technical assistance for those who have difficulty complying. Non-compliance penalties can be avoided by seeking information and variances when appropriate from the MAAB. (See “*State Variance Process*” below.)

Compliance

When a question of interpretation or applicability arises, architects can request an advisory opinion from the MAAB. Advisory opinions issued by the MAAB may be relied upon by the persons requesting them, but they do not take the place of a variance.

Advisory  
Opinions

---

Consultants to the MBTA should work with the appropriate MBTA staff to prepare a written request for an opinion. Good documentation of existing conditions in the form of photographs and plans will help the MAAB give the best possible advice. The request for an opinion shall be submitted under the signature of the appropriate MBTA staff person.

**State  
Variance  
Process**

In the renovation of existing buildings there may be some MAAB regulations that cannot be met. Problem areas that meet the test of “impracticability”—a solution is technologically infeasible or results in excessive and unreasonable costs without any substantial benefit to persons with disabilities—may be granted a variance. MBTA approval is required prior to a variance application. Need for a variance should be identified and brought to the MBTA’s attention at 30% completion of the design.

If a barrier in an existing building cannot be removed or if the building cannot be altered to meet the regulations, then the architect, with the assistance of the MBTA staff, should prepare a written request for a variance which the MBTA will submit. This request should document as thoroughly as possible the reasons that the regulations cannot be met, the attempts made to comply with the code, and any alternative measures taken to provide as much accessibility as possible.

The MAAB can then opt for an adjudicatory hearing or an informal discussion with the MBTA and its station designer. At the hearing, the architect presents materials illustrating why a variance is needed, such as photographs, plans, sections, and cost estimates. If a variance is denied, decisions made by the MAAB can be appealed in accordance with the General Laws of Massachusetts.

**Technical  
Assistance**

The MAAB makes technical assistance available to architects. The executive director of the MAAB can provide information and referrals to state agencies such as the Office of Handicapped Affairs, the Massachusetts Commission for the Blind, and the Massachusetts Commission for the Deaf and Hard of Hearing for advice on technical issues.

# 3

## DESIGN OF TRANSIT SYSTEM ELEMENTS

---

## SITE

- Schematic Site Design
  - Parking
  - Passenger Loading Zone
  - Accessible Route
  - Curb Cuts
- 

## ENTRANCE

---

## FARE COLLECTION

---

## VERTICAL CIRCULATION

---

## HORIZONTAL CIRCULATION

---

## PLATFORM

---

## INTERIOR STATION ELEMENTS

---

## TOILET ROOMS

---

## Schematic Site Design

An MBTA station site must provide access to everyone, including people with mobility and sensory impairments, elderly people, and people with temporary physical limitations. The challenge of providing access can be eased if access solutions are incorporated into the early design concept. In the following sections, schematic issues are discussed first and design details follow so that you can focus on what is important to your phase of work.

When the opportunity to select a new headhouse site arises, access needs should be considered in the selection process.

### Headhouse Site

A new headhouse is normally built in a visually prominent location. A headhouse which can be easily spotted in the street-scape will improve wayfinding for everyone. In particular, non-English-speakers, tourists, and cognitively impaired people will have an easier time finding a station which is in a visually prominent location.

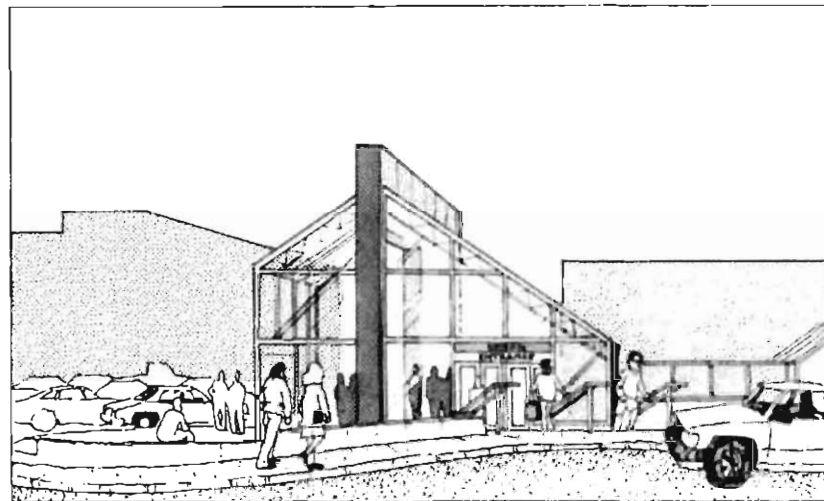

**Headhouse at Visually Prominent Location**



Headhouse siting should minimize the length of the route of travel from the entrance to the fare collection area. When a new headhouse is being added to an existing station, consider locating the headhouse in close horizontal proximity to an existing fare collection area. For many people with limited stamina, the distance they must travel determines whether or not the trip is possible.

### Accessible Route

Since an accessible route of travel to the headhouse will have to be provided in the later stages of design, consider the degree of access already provided at the site. The headhouse should be located along a regularly used pedestrian route which is accessible to people with disabilities. Minimizing the vertical rise from the surrounding areas to the headhouse entrance will simplify the later challenge of designing an accessible route of travel. The selected site should require MBTA riders to combat as little automobile traffic as possible.

Although walkway slopes must be kept to a minimum, hilly sites are not necessarily bad. A sloping site can present opportunities to bridge a floor level to an uphill point on the site.

*(For design details, see "Accessible Route," page 33.)*

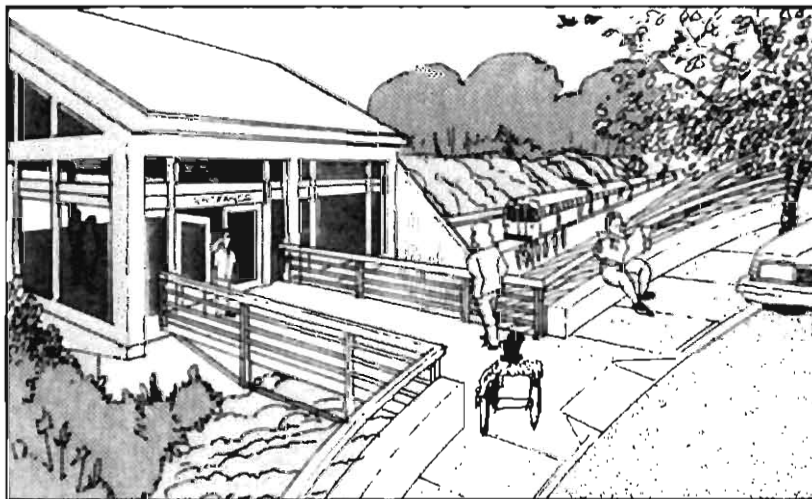

**Bridge from Entrance to Uphill Point on Site**

*MAAB 23.2 ...Where the designated parking space cannot be located within 200 feet of the accessible entrance(s), an accessible drop-off area shall be provided within 100 feet of such entrance(s).*

If a parking lot or a passenger loading zone currently exists or is in the prospective plans, the headhouse and the parking lot should be sited as close together as possible. A short and efficient path of travel from the parking/drop-off area to the entrance can make travelling easier for people with stamina and mobility difficulties.

The MAAB Regulations require a passenger loading zone (also known as a drop-off area) within 100 feet of the entrance whenever existing or proposed parking for the facility is more than 200 feet from the entrance. (At commuter rail stations, the platform is considered to be the entrance.) Passenger loading zones are not required at stations which do not have parking facilities. However, passenger loading zones should be provided whenever possible. They are especially important when The RIDE is interfaced with fixed route service. (The RIDE uses accessible MBTA vans to give eligible people rides when fixed route services are inaccessible to them.) Reducing the travel distance from the car to the station is crucial for people with mobility limitations.

*(For design details, see "Parking," page 25, and "Passenger Loading Zone," page 31.)*

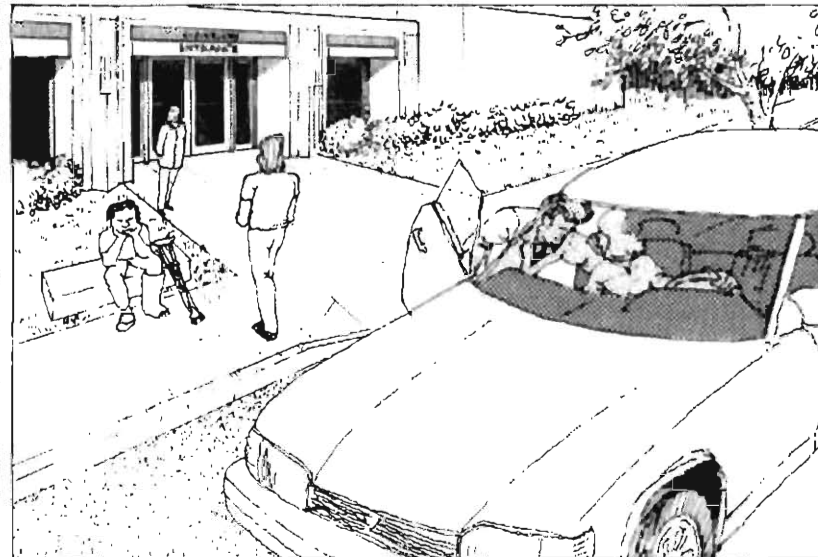

**Passenger Loading Zone Within 100 Feet of Entrance**

## **Parking and Passenger Loading Zones**

### Schematic Design Summary

The site design should provide:

- direct accessible pathways from public sidewalks and transit stops to the accessible entrance
- an accessible route of travel integral with the primary route for the general public
- minimal distances from parking or vehicle drop-off to the station entrance
- minimal distances from the headhouse entrance to fare collection
- an accessible drop-off area if required or a variance from the MAAB

## Parking

MAAB 23.4 Such spaces shall be provided as follows:

Total Spaces	Required Spaces
15-25	1 space
26-40	5%, but not <2 spaces
41-100	4%, but not <3
101-200	3%, but not <4
201-500	2%, but not <6
501-1000	1.5%, but not <10
1001-2000	1%, but not <15
2001-5000	.75%, but not <20
5001+	.50%, but not <30

UFAS 4.1.1 If parking spaces are provided for employees or visitors, or both, then accessible spaces...shall be provided in each such parking area in conformance with the following table:

Total Parking in Lot	Required Minimum Number of Accessible Spaces
1-25	1
26-50	2
51-75	3
76-100	4
101-150	5
151-200	6
201-300	7
301-400	8
401-500	9
501-1000	2% of total
1001+	20 plus 1 for each 100 over 1000

MAAB 23.2 Specifically designated parking spaces for the physically handicapped shall be the closest located spaces in the lot to the accessible entrance(s). Where the designated parking space cannot be located within 200 feet of the accessible entrance(s), an accessible drop-off area shall be provided within 100 feet of such entrance(s). (UFAS 4.6.2)

The number of cars that will be accommodated in the lot determines the required number of accessible parking spaces. At facilities with multiple lots the number of required spaces should be calculated *per lot*, not by the total number of spaces at the facility. For each lot, calculate the number required according to both UFAS and MAAB, and use the greatest calculated number. To determine the total required number of accessible parking spaces, compute the numbers on a lot by lot basis and add them together. (See charts at left.)

Number of Parking Spaces

Within the parking lot, the designated handicapped parking spaces should be the spaces closest to the accessible entrance (or platform at commuter rail stations). They should be located at the end of a row or adjacent to a sidewalk to minimize conflict between cars and people with disabilities.

Location of Accessible Parking

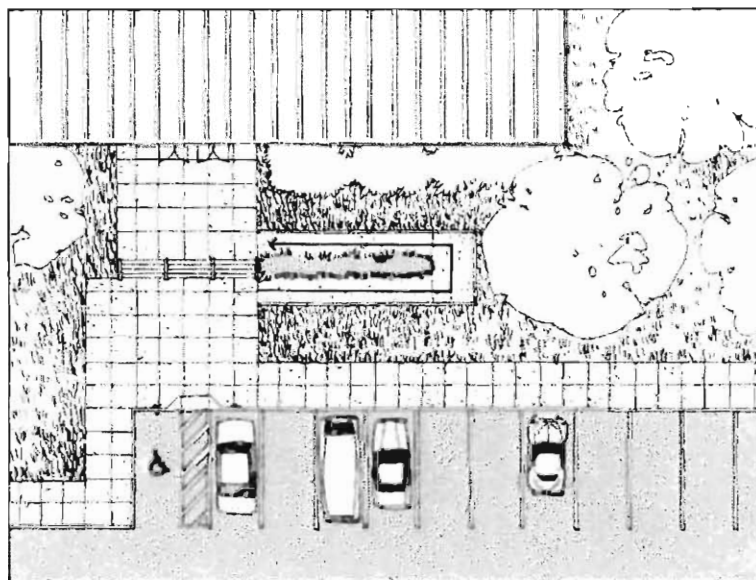

### Locate HP Parking Closest to Accessible Entrance

Generally, accessible spaces must be distributed proportionally among all lots unless a special arrangement with the Access Board is made. However, if all parking spaces are on one side of the tracks, the total number of accessible parking spaces may be consolidated in the lot closest to the accessible route. Sufficient signage must be used in the auxiliary lots to direct people to the accessible spaces.

People in wheelchairs can be difficult to see in a parking lot when they must travel behind parked cars. If there is a sidewalk adjacent to the spaces, provide a curb cut so that a person in a wheelchair can move directly onto the sidewalk. (See "Curb Cuts," page 38.)

**Parking Space Size**

A 13 foot wide parking space (8 foot space with a 5 foot access aisle) allows most people to get a wheelchair in and out of a car without bumping into the adjacent car. However, some vans equipped with lifts require extra space because the wheelchair has to leave the lift platform before any turns can be made. Van parking should be 16 feet wide (8 foot space with an 8 foot access aisle). The Office of Transportation Access recommends at least one van parking space in lots with less than 500 spaces, and two van parking spaces in lots with 500 or more spaces. Van spaces should be on the first level of parking garages or outdoors if the garage's vertical clearance is less than 114 inches.

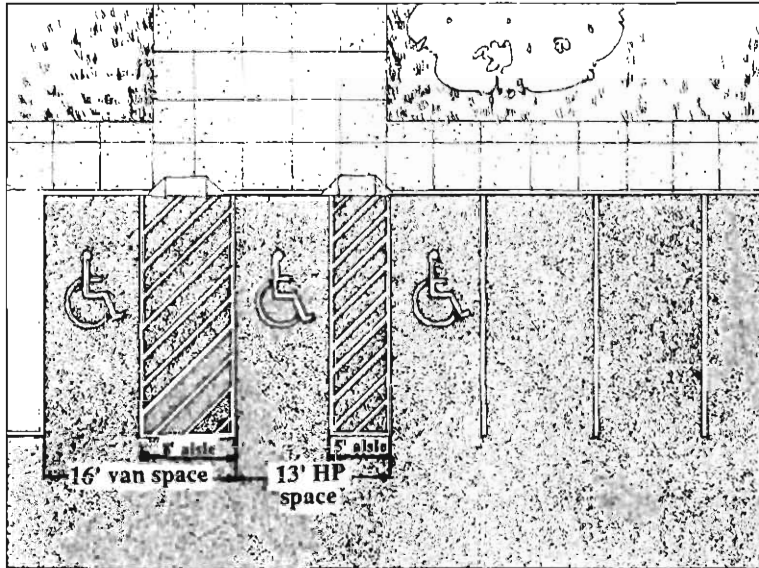

**Accessible Parking Space Dimensions**

Accessible parking spaces can be provided most economically by grouping two 8 foot spaces around a shared 5 foot access aisle.

*MAAB 23.6 Sidewalks: Where sidewalks are provided at such parking spaces, a curb cut shall be installed at each specially designated space or pair of spaces, so that the handicapped persons are not required to enter the stream of traffic to attain access to sidewalks. If the alternative described in Section 23.5 is used (two spaces sharing a single access aisle) the curb cuts shall be installed where the center aisle meets the sidewalk.*

*MAAB 23.8 Walks and ramps required as a means of egress leading from specially designated parking spaces for the handicapped in parking lots, garages, or other parking facilities, shall be in conformity with all sections of these Regulations.*

*UFAS 4.6.3 Parking spaces for disabled people shall be at least 96 inches wide and shall have an adjacent access aisle 60 inches wide minimum. Parking access aisles shall be part of an accessible route to the building or facility entrance and shall comply with 4.3. Two accessible parking spaces may share a common access aisle. Parked vehicle overhangs shall not reduce the clear width of an accessible circulation route... (MAAB 23.5)*

*UFAS 4.6.6 Vertical Clearance. ...If accessible van parking spaces are provided, then the minimum vertical clearance should be 114 inches.*

**Existing  
Parking Lots**

In existing parking lots, it may be less costly to combine two regular parking spaces into one accessible parking space, rather than to re-stripe an entire lot. This results in leftover width. To prevent misuse by a second vehicle, stripe the additional width.

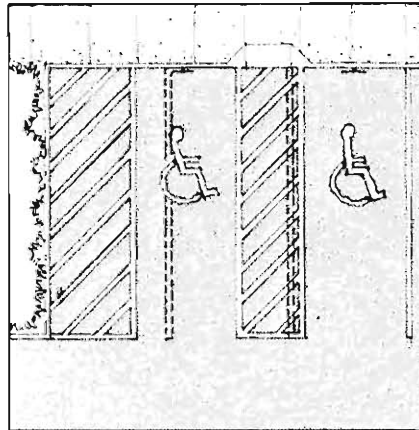

**Stripe Remaining Width to Prevent Misuse**

*MAAB 23.9 Parking surface areas required to be accessible for the handicapped shall be paved or hard packed smooth surface, and shall not slope more than one-in-twenty (1:20) or five percent (5%). (UFAS 4.6.3)*

Parking spaces should be as flat as possible. Cross slopes cause problems for people using wheelchairs because it is hard to open a car door on the uphill side and keep it open while transferring into the chair. On the downhill side, the transfer between a wheelchair and a car is dangerous because the wheelchair tends to roll away from the car.

**Slope of  
Parking  
Spaces**

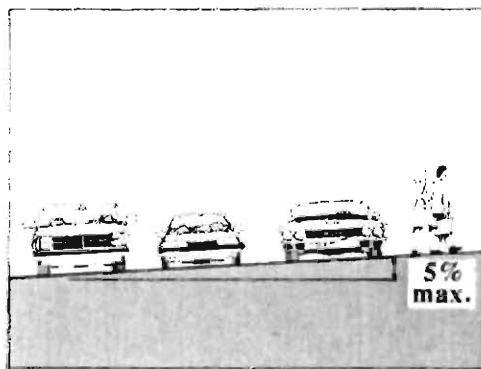

**Cross Slopes Should Be Minimized**

*MAAB 20.1 Wherever a passenger loading zone or parking area is provided, an accessible path of travel to an accessible entrance is required.*

People using wheelchairs are often not visible from a driver's viewpoint, particularly if they are behind the car. For this reason, a safe path of travel through the parking lot should be provided. If no sidewalk through the parking lot exists, a designated walkway should be established. Painted lines (such as zebra striping) and signs displaying the International Symbol of Accessibility should mark the path. (For slope and surface requirements, see "Accessible Route," pages 34-5.)

**Designated  
Route**

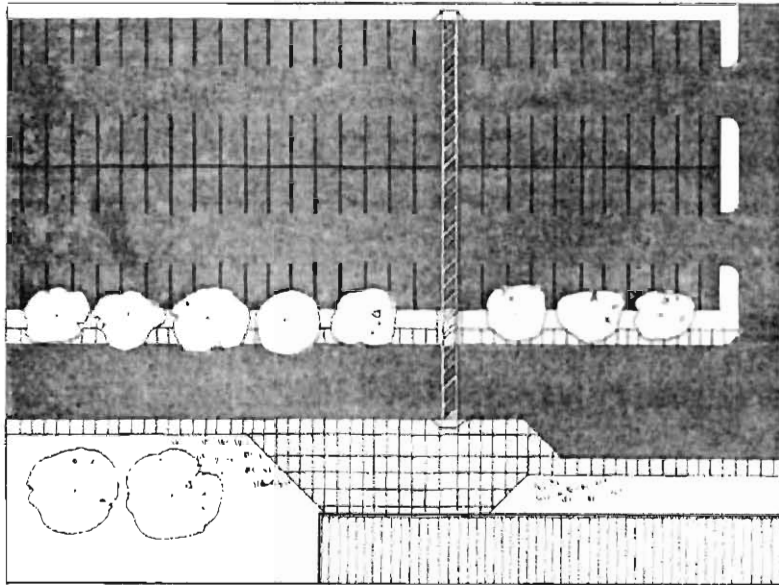

**Accessible Route Through Parking Lot**

**Parking Structures**

Many wheelchair users drive extremely tall vans equipped with wheelchair lifts. These high-top vans may be 8 feet tall to allow people to drive sitting in their wheelchairs. Clearance to all drop-off areas should be set at 114 inches. If accessible van parking spaces are provided, clearances to these spaces should also be 114 inches. In existing stations, if vertical clearance within a parking structure is less than 114 inches, provide two accessible van spaces outside the parking structure no further from the station than the structure itself. Accessible parking spaces must be on the ground level near the accessible entrance, or adjacent to an accessible elevator on another level.

*MAAB 23.3 In multi-level garages where no elevator is provided, such spaces shall be located near the accessible entrance.*

*UFAS 4.6.6 Vertical Clearance. Provide minimum vertical clearances of 114 inches at accessible passenger loading zones and along vehicle access routes to such areas from site entrances. If accessible van parking spaces are provided, then the minimum vertical clearance should be 114 inches.*

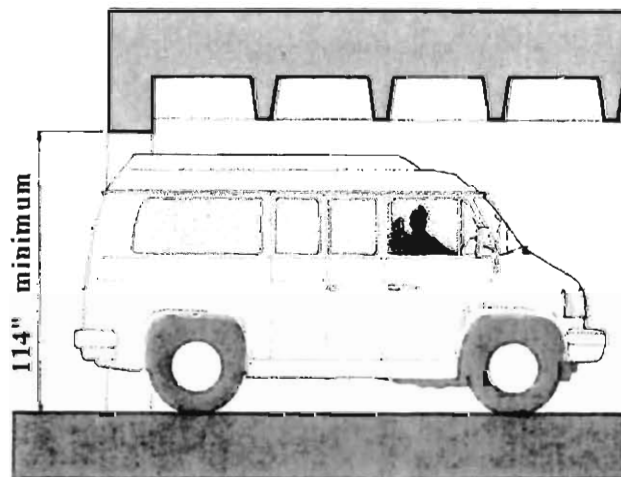

**Accessible Van Space**

When an elevator is used in parking garages, an intercom must be connected to the fare collector's booth.

Avoid designating existing parallel or curbside parking as accessible parking. A disabled person who drives may have to transfer into his wheelchair on the street side, running the risk of being hit by a car. Safer curbside parking can be designed by using the criteria for accessible drop-off areas—12 foot width and a curb cut—and adding a sign that limits its use to disabled drivers. Place the curb cut at the head or foot of the parking space so that the car does not block it.

**Curbside Parking**

*MAAB 23.7 Identification: Such spaces shall be identified by a sign at each space or pair of spaces. This sign shall be located at a height of not less than 5 feet, nor more than 8 feet to the top of the sign. The sign shall contain the "International Symbol of Accessibility" as shown in Section 40 and may also include wording identifying this use. (UFAS 4.6.4)*

In crowded parking lots, non-disabled drivers are tempted to use the designated accessible parking spaces. To visually reinforce the importance of these spaces, paint one International Symbol of Accessibility on the ground, and post an International Symbol of Accessibility sign in front of the space. The sign also helps disabled drivers find the spaces.

**Signage**

*MAAB 24.1 Exterior signage shall be located so as to not become a hazard or an obstacle itself. Overhead signs should be carefully located high enough to avoid conflict with pedestrians.*

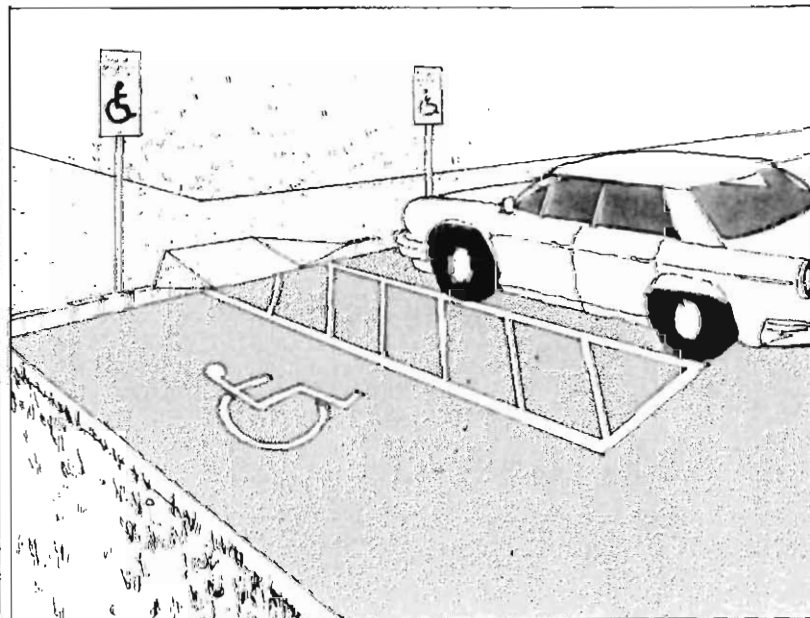

**Paint and Post International Symbol of Accessibility**



### **Parking Lot Fee Collection Boxes**

In lots where cash boxes are used, one of several ways to assure accessibility should be used: 1) if there is only one location for the cash box, make sure it is on the accessible route of travel; 2) locate and number HP spaces so that their cash box slots are between 36 and 48 inches; 3) if the cash boxes cannot be located on an accessible route of travel, locate cash boxes at the HP spaces. Since it is also possible for a person using a wheelchair to park in a regular space, slots for general parking should be below 54 inches whenever possible.

## Passenger Loading Zone

*MAA B 20.1 Wherever a passenger loading zone or parking area is provided, an accessible path of travel to an accessible entrance is required.*

*MAA B 20.2 Disembarking areas for vehicles shall be provided at an accessible entrance.*

*MAA B 23.2 ...Where the designated parking space cannot be located within 200 feet of the accessible entrance(s), an accessible drop-off area shall be provided within 100 feet of such entrance(s).*

*UFAS 4.6.5 Passenger loading zones shall provide an access aisle at least 60 inches wide and 20 feet long adjacent and parallel to the vehicle pull-up space. If there are curbs between the access aisle and the vehicle pull-up space, then a curb ramp complying with 4.7 shall be provided. Vehicle standing spaces and access aisles shall be level with surface slopes not exceeding 1:50 in all directions.*

Passenger loading zones permit a disabled person who may arrive by The RIDE, cab, bus, or a car driven by a friend to disembark safely near the accessible entrance. Whenever possible, a passenger loading zone should be located near the accessible entrance and should be connected to the entrance by an accessible route.

As discussed in the schematic design criteria, the MAAB Regulations require a passenger loading zone (also known as a drop-off area) within 100 feet of the entrance whenever existing or proposed parking for the facility is more than 200 feet from the entrance. If a passenger loading zone cannot be provided within 100 feet of the entrance, a variance must be obtained prior to construction. This does not apply to stations which do not have parking facilities.

The drop-off area needs to be wide enough to provide a 60 inch wide and 20 foot long aisle space between the vehicle and the curb, allowing people to maneuver in and out of the vehicle. Provide a curb cut within the drop-off area so that users do not have to go out into traffic to get onto the sidewalk. (See "Curb Cuts," page 38.)

**Passenger Loading Zone Location**

**Passenger Loading Zone Design**

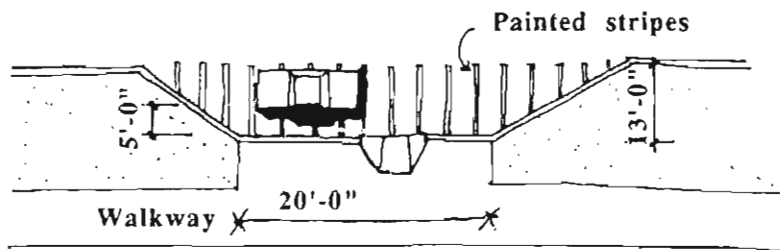

**Passenger Loading Zone With Curb**

## Curbs vs. Bollards

Some passenger loading zones are built without curbs, using bollards instead to mark the separation between the vehicle space and the sidewalk space. Bollards, however, do not replace curbs as a cue for visually impaired people. Because the cane sweep may not locate the bollards, pedestrians with visual impairments may have no way of knowing that they are leaving a walkway and moving onto a street. If no curb is provided, install a yellow, 24 inch wide strip of textured surface at the edge of the walkway to warn of transition to a vehicular area. The surface must be texturally different from the type of material used as a warning strip at platform edges.

*MAAB 21.4 Uncurbed intersections: If there is no curb cut at the intersection of a walk and an adjoining street, parking lot, or driveway, the walk shall have a tactile warning texture or be painted yellow at the edge of the vehicular way.*

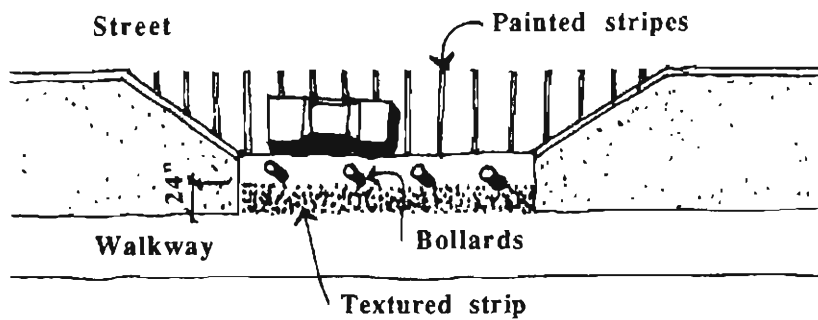

**Passenger Loading Zone Without Curb**

## Accessible Route

An accessible route is defined as “a continuous unobstructed path connecting all elements and spaces in a building or facility.... Exterior accessible routes may include parking access aisles, curb ramps, walks, ramps, and lifts.”

*UFAS 4.3.2 At least one accessible route within the boundary of the site shall be provided from public transportation stops, accessible parking spaces, passenger loading zones if provided, and public street or sidewalks to the accessible building entrance they serve.*

An accessible route of travel free from steps must link the accessible station entrance with public sidewalks, bus stops, parking and passenger loading zones. A safe path of travel through the parking lot is required by the MBTA.

**Location**

Providing an accessible route of travel at a new or existing station site also includes providing well-lit crosswalks with curb cuts and pedestrian crossing signals at adjacent streets. Making these provisions will require coordination with local officials or the owners of adjacent properties.

The accessible route should be the same path of travel used by the general public. Where the general route uses stairs and the accessible route must deviate to a ramp, the ramp should be located close to the stairs so that it still functions as an integral element of the public route. Signage should direct people along the accessible path if it deviates greatly from the general route of travel.

At an MBTA station, people may be transferring from bus to subway or vice versa. Hence, both the station’s accessible entrance(s) and accessible exit(s) must be linked to the busway by an accessible route. The accessible route requirements should be applied to the pedestrian circulation space and the curb cuts.

**Busways**

Catch basins have traditionally been located at street corners. Be sure that they are not located in the path of travel at a curb cut. Select a location which avoids flooding the curb cut in wet weather. Catch basins should be designed to drain water away from curb cuts to prevent puddles and ice.

**Drainage**

**Pathway Width**

Make walkways wide enough so that someone using a wheelchair and a person walking can walk along together or pass each other. If the walkway is less than 60 inches wide, provide passing spaces at least 60 inches by 60 inches at reasonable intervals not exceeding 200 feet.

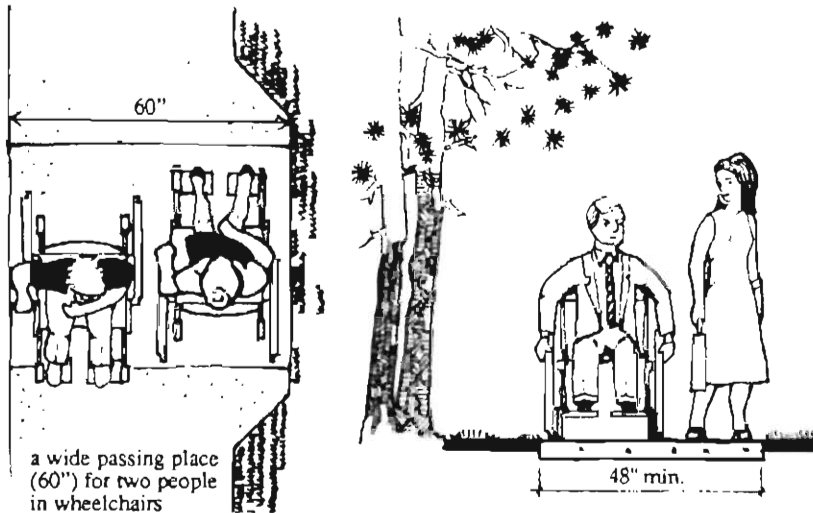

**Minimum Pathway Width, With Wider Passing Space**

*MAAB 22.1 Width of walks and walkways shall be not less than 48 inches.*

*MAAB 21.2 Sidewalks on streets and ways shall be at least 48 inches in width...*

*UFAS 4.3.4 If an accessible route has less than 60 inches clear width, then passing spaces at least 60 inches by 60 inches shall be located at reasonable intervals not to exceed 200 feet. A T-intersection of two corridors or walks is an acceptable passing place.*

**Pathway Slope**

Walkways with a slope greater than 1:20 are considered to be ramps and must be treated as such. Exterior ramps should be avoided because they are difficult to keep clear of ice and snow. It is almost impossible to use a wheelchair, cane or crutches on snow. For level changes from grade to the platform, and for pedestrian overpasses, ramps must be roofed. There may be other circumstances as well which require ramps to be roofed. These should be considered by the MBTA on a case by case basis.

*MAAB 22.1 Where the slope of walks exceed one-in-twenty (1:20) or five percent (5%) it shall be treated as a ramp and the regulations applicable to ramps shall apply. (UFAS 4.3.7)*

*MAAB 22.5 Pedestrian bridges, underpasses and overpasses shall be considered as walkways or ramps and shall comply with Sections 22 and 25.*

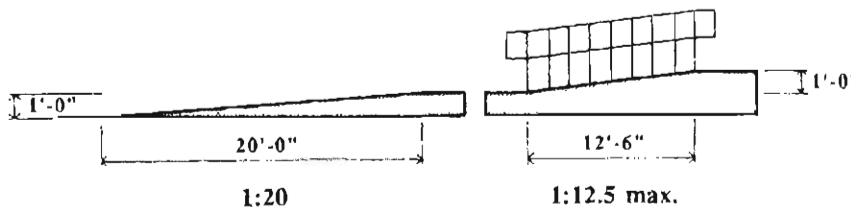

**Slopes Exceeding 1:20 Must Be Treated As Ramps**

*UFA-S 4.3.7 ...Nowhere shall the cross slope of an accessible route exceed 1:50.*

*MAA B 21.2 (The slope of) sidewalks on streets and ways shall be determined by the natural topography of the ground. Section 25, (Ramps) or these Regulations need not apply to such sidewalks except as provided under Section 22.1.*

*MAA B 20.4 Site grading and drainage of topography shall be designed so as to minimize pooling of water or accumulation of ice or flow of water across sidewalks and driveways.*

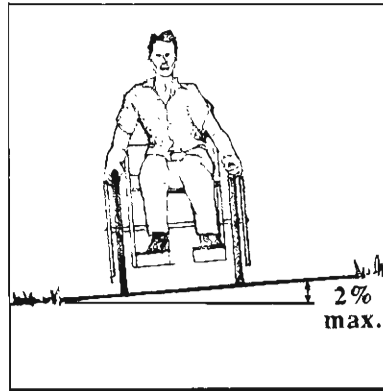

When a wheelchair user travels across a slope, he must continually compensate to correct the chair's inclination to run downhill. Minimize cross slope so that it does not exceed 2% (1:50).

**Cross Slope**

**Minimize Cross Slope**

Soft or uneven surfaces, such as loose stone or sand, make the going rough for people in wheelchairs, people using crutches, and people who walk with difficulty. Jointed surfaces, such as brick or concrete pavers, can be a real hazard if they have uneven joints. When these materials are used, specify a firm base, narrow joints set to close tolerances, and edges flush with adjoining surfaces.

**Pathway Surfaces**

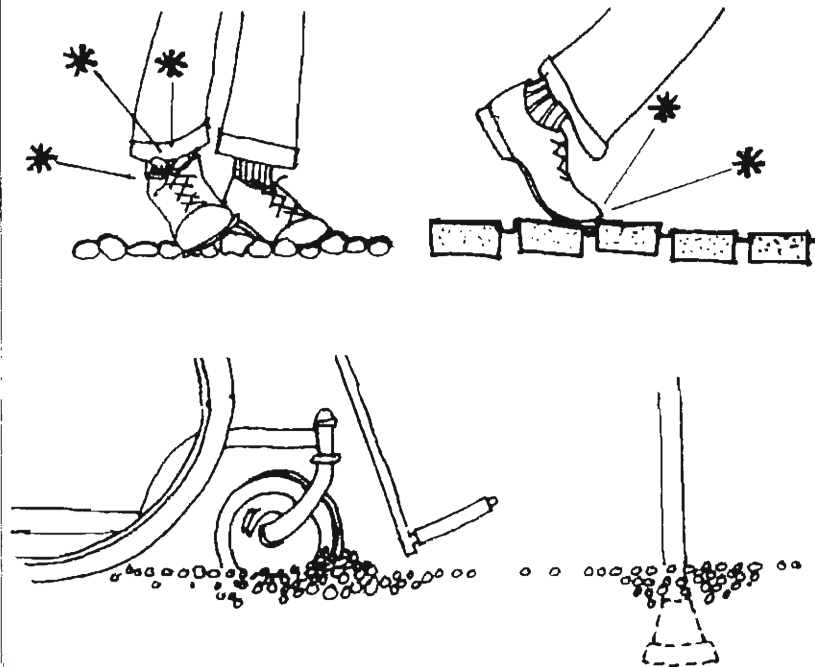

**Soft, Uneven or Jointed Surfaces Can Be Hazardous**

Changes in level greater than 1/2 inch are sometimes impossible for a wheelchair user to cross. Therefore, no level change greater than 1/2 inch is permitted unless a ramp is provided. Level changes between 1/4 inch and 1/2 inch must be beveled with a slope of 1:2.

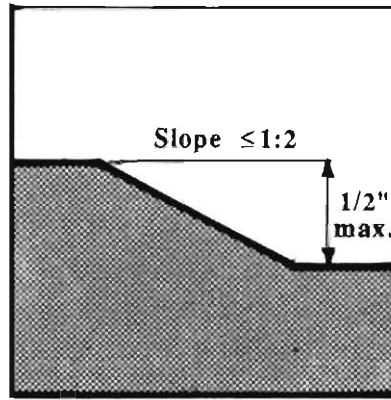

**Level Change Beveled With a Slope of 1:2**

**Gratings/ Catch Basins**

Avoid locating grates or catch basins in pathways where people's wheels or high heels can get stuck in them. When there is no alternative, be sure the grating has a clear opening of no more than 1/2 inch in the narrow direction, and that the long dimension is at right angles to the direction of pedestrian travel along the walk. There are grates made with openings less than 1/2 inch, which are even safer.

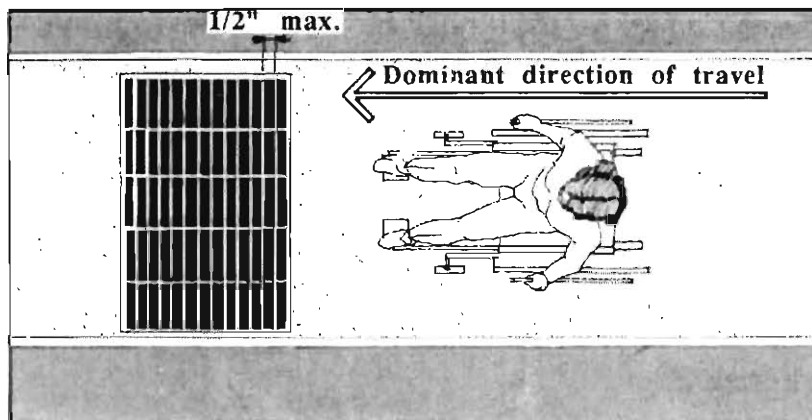

**Grating Perpendicular to Travel Direction**

**Utility Covers**

Avoid locating utility covers in walkways. The heavily patterned surface can trip people who wear fixed ankle braces, and deflect or even stop the wheels of wheelchairs.

*UFAS 4.5.1 Changes in Level. Changes in level up to 1/4 inch may be vertical and without edge treatment. Changes in level between 1/4 inch and 1/2 inch shall be beveled with a slope no greater than 1:2. Changes in level greater than 1/2 inch shall be accomplished by means of a ramp that complies with 4.7 or 4.8.*

*MAAB 22.2 Such walks and walkways shall have continuous common surfaces, not interrupted by steps or abrupt changes in level greater than 1/2 inch. Such surfaces shall be non-slip.*

*MAAB 22.4 Wherever there is an intersection of walks or walkways, streets, public ways, driveways or parking lots, each shall blend to a common level.*

*MAAB 22.3 Only a non-slip finish material may be applied to any walk or walkway.*

*UFAS 4.5.4 Gratings. If gratings are located in walking surfaces, then they shall have spaces no greater than 1/2 inch wide in one direction. If gratings have elongated openings, they shall be placed so the the long dimension is perpendicular to the dominant direction of travel.*

*UFAS 4.4.1 General. Objects projecting from walls (for example, telephones) with their leading edges between 27 inches and 80 inches above the finished floor shall protrude no more than 4 inches into walks, halls, corridors, passageways, or aisles. Objects mounted with their leading edges at or below 27 inches above the finished floor may protrude any amount. Free-standing objects mounted on posts or pylons may overhang 12 inches maximum from 27 inches to 80 inches above the ground or finished floor. Protruding objects shall not reduce the clear width of an accessible route or maneuvering space.*

*MAAB 24.1 Exterior signage shall be located so as to not become a hazard or an obstacle itself. Overhead signs should be carefully located high enough to avoid conflict with pedestrians.*

Locate objects such as telephones and drinking fountains beside, rather than in, the pathway so they do not impede the path of travel and are not hazardous to people with visual impairments.

Signs mounted overhead along pathways or sidewalks should be mounted at least 80 inches above the ground where they will not endanger pedestrians with visual impairments. (See page 109 for discussion of solutions for elements which project into pathways.) Select trees that do not need extensive pruning to keep them from protruding into walkways. When trimmed, branches should also be at least 80 inches above the ground.

**Protruding Objects**

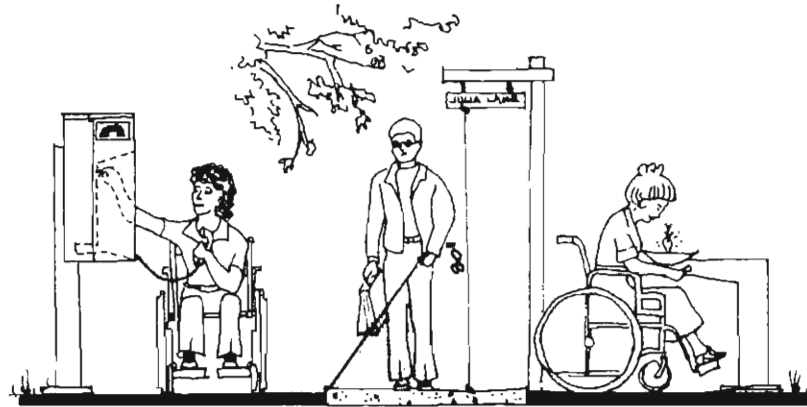

**Sign Mounted Overhead**



## Curb Cuts

### Curb Cut Location

Curb cuts are required whenever an accessible route crosses a curb such as between parking areas and the sidewalk.

Although curb cuts are needed by mobility impaired people, they can be hazardous to people with visual impairments who use the curb as a “cue” to know when they are entering the street. One way to design safe curb cuts is to locate them out of the usual line of pedestrian flow. In this way a person with visual impairment following the “shoreline” of the sidewalk will encounter the curb rather than inadvertently entering the street by way of the curb cut.

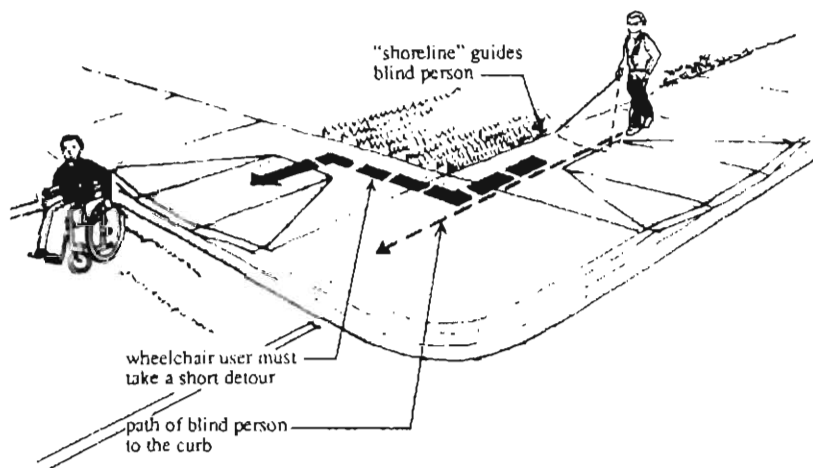

Following the “Shoreline” of the Sidewalk

Sometimes one curb cut only is installed at the corner, rather than one on each side of the corner. This reduces the number of installations and avoids confusing visually impaired pedestrians, but it is a dangerous practice because such curb cut locations direct wheelchair users into a part of the intersection where drivers do not expect them. People who use canes to find curb cuts may find themselves walking diagonally across the street without realizing it. If a corner-type curb cut is installed, the curb cut plus a 48 inch clear space beyond the

*MAAB 21.1 Curb cuts (sidewalk ramps): Whenever sidewalks or curbs on streets and ways are constructed, reconstructed or repaired, curb cuts are required. Curb cuts shall comply with the following:*

*UFAS 4.7.1 Curb ramps complying with 4.7 shall be provided wherever an accessible route crosses a curb.*

*MAAB 21.1 Location: There shall be curb cuts at each corner of each intersection, located within the crosswalk and/or the pedestrian path of travel.*

*UFAS 4.7.8 Obstructions: Curb ramps shall be located or protected to prevent their obstruction by parked vehicles.*

*UFAS 4.7.9 Curb ramps at marked crossings shall be wholly contained within the markings, excluding any flared sides.*

*MAAB 21.1.2 When curbs or sidewalks are constructed or reconstructed on one side of the street, curb cuts shall also be installed on the opposite sides of the street, where there is a pedestrian path of travel.*

*MAAB 21.1.3 If driveways intersecting sidewalks have side curbs, curb cuts shall also be provided therein.*

*MAAB 21.3 Islands: Any raised islands in crossings shall be cut through level with the street, or shall have curb cuts at both sides and a level area at least 48 inches long in the part of the island intersected by the crossings. (UFAS 4.7.11)*

UFAS 4.7.10 ...The bottom edge of diagonal curb ramps shall have 48 inches minimum clear space..If diagonal curb ramps are provided at marked crossing, the 48 inch clear space shall be within the markings. If diagonal curb ramps have flared sides, they shall also have at least a 24 inch long segment of straight curb located on each side of the curb ramp and within the marked crossing.

MAAB 21.1.6 Sides of curb cuts shall extend no less than 24 inches at the curb. There shall be no vertical curbing at the side of the curb cut.

MAAB 21.1.7 Curb height at intersections shall not exceed 7 inches.

MAAB 21.1.5 Width of curb cuts shall be no less than 36 inches, not including sloped sides. (UFAS 4.7.3)

MAAB 21.4 Uncurbed intersections: If there is no curb cut at the intersection of a walk and an adjoining street, parking lot, or driveway, the walk shall have a tactile warning texture or be painted yellow at the edge of the vehicular way.

MAAB 21.1.4 Slope of curb cuts shall not exceed one-in-twelve (1:12)...Where sidewalks are too narrow to install a straightline curb cut at a slope of one-in-twelve (1:12), the sides of the curb cut shall slope at one-in-twelve (1:12). (UFAS 4.7.2)

curb cut into the street must be wholly contained within the marked crossings. They should also have a 24 inch long segment of straight curb within the marked crossing to each side of the the curb ramp.

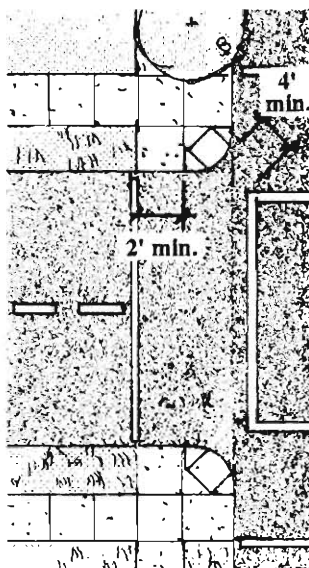

Acceptable

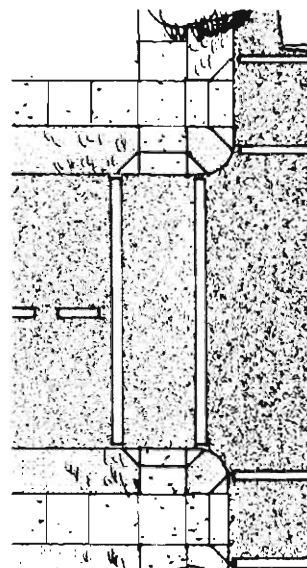

Better

**Corner-Type Curb Cut vs. Curb Cuts on Both Sides**

Curbs at intersections should be no higher than 7 inches (like stair risers), to minimize the effort someone with respiratory or balance problems must exert.

At intersections without curbs, where the street and walkway are at the same elevation, yellow striping and surface texture warnings that are detectable underfoot are necessary to warn visually impaired people where the pedestrian zone ends.

Of the two types of curb cuts—flared and returned—only flared is allowed in Massachusetts. Unlike the returned curb, the flared curb provides a ramped transition in three directions. This is especially important when a curb cut interrupts the full width of a narrow 48 inch wide sidewalk.

**Curb Design**

**Curb Cut Design**

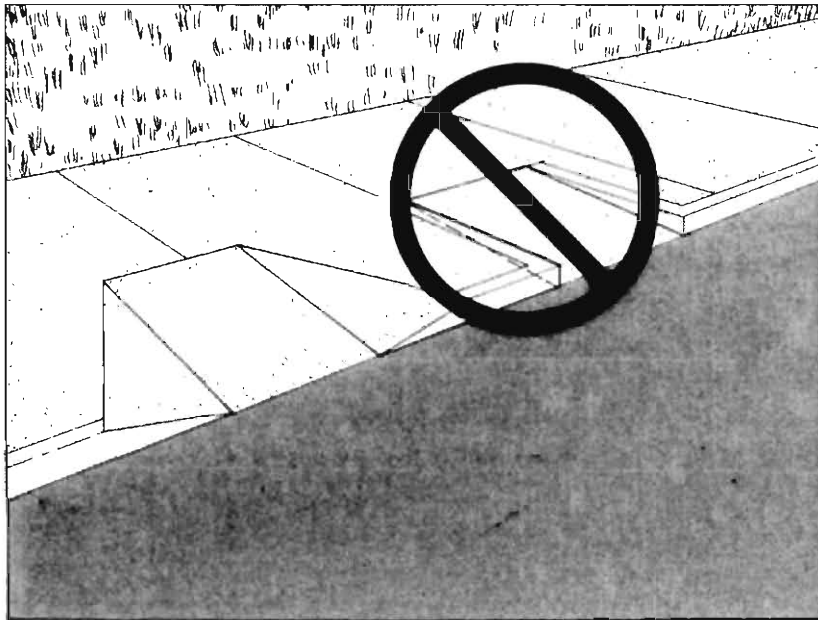

**Flared and Returned Curb Cuts**

Be sure to design a smooth and continuous transition from the curb cut onto the street. Even a slight lip is enough to stall the wheelchair at a critical and dangerous position on the road. A person with little trunk strength or balance may be pitched out of the chair if it stops suddenly when it hits the lip. Because the 1/2 inch lip specified in MAAB 21.1.4 is known to be hazardous in practice, the Massachusetts Department of Public Works now uses federal standards which dictate *no* lip.

*UFAS 4.7.2 Transitions from ramps to walks, gutters, or streets shall be flush and free of abrupt changes. Maximum slopes of adjoining gutters, road surface immediately adjacent to the curb ramp, or accessible route shall not exceed 1:20.*



Lip on Curb Cut

*MAAB 21.1.8 Texture of curb cut surface, including sloping sides, shall be roughened in the direction of the slope, or shall be painted yellow.*

*UFAS 4.5 Ground and floor surface along accessible routes and in accessible rooms and spaces, including floors, walks, ramps, stairs, and curb ramps, shall be stable, firm, slip-resistant, and shall comply with 4.5.*

The code requires a texture on curb cut surfaces to make them detectable for visually impaired persons. This surface should be detectable underfoot.

**Curb Cut  
Surface**

---

SITE

---

**ENTRANCE**

Schematic Entrance Design ■

Entrance ■

---

FARE COLLECTION

---

VERTICAL CIRCULATION

---

HORIZONTAL CIRCULATION

---

PLATFORM

---

INTERIOR STATION ELEMENTS

---

TOILET ROOMS

---

## Schematic Entrance Design

Accessible design is particularly important at the entrance. Because the entrance is not something the rider can circumvent, a barrier at the entrance—no matter how small—can render the station inaccessible and prohibit the use of the MBTA system. An accessible entrance conveys a sense of welcome to people with disabilities and assures them that the MBTA is concerned with their needs.

*MAAB 26.1 The primary public entrance(s) of a building shall be accessible by persons in wheelchairs.*

*MAAB 26.4 The accessible entrance(s) shall be on a level which permits access to building elevators where provided.*

The MAAB regulations state that all primary entrances must be accessible. Primary entrances have been interpreted by the MBTA to include all heavily trafficked entrances. Usually the main challenge in making an existing entrance accessible is providing an alternative to stairs en route to the fare collection and platform levels. Ramps, elevators, and inclined elevators should be considered as possible vertical circulation solutions. (See “Vertical Circulation,” page 67.)

**Accessible  
Entrance**

If a choice must be made as to which entrance(s) will be accessible, the entrance(s) chosen should attract a high percentage of riders. It should be in a visually prominent location, and the approach to the entrance should cause the least conflict between riders and vehicular traffic. The entrance closest to the drop-off area should be accessible, particularly for an easy transfer from The RIDE to fixed route service. If an entrance is provided through a special facility such as an office park or a popular public attraction, that entrance must be accessible when it is technically feasible. People with disabilities must have the same convenient access to office parks and public attractions as non-disabled people so that they can get to their workplaces or use community facilities.

Although it may not be feasible to render every existing entrance accessible, people who have disabilities should not be routed to a distant and secondary entrance. A visually prominent entrance is more likely to be accepted by the community and the MAAB than an entrance that feels like a back door.

If you are designing a new station, or if the cost of a renovation is more than 25% of the replacement cost of the station, a variance must be obtained from MAAB for any entrances which cannot be made accessible. Major decisions of this type should be taken to the MAAB in the preliminary design stage. The variance application should explain in detail the options which have been considered and the proposed provisions. Obtain the variance before the design is complete and construction begins.

### Schematic Design Summary

The entrance design should have:

- an accessible route free from steps to the entrances
- a prominent accessible entrance which connects to the fare collection and platform levels by elevator or ramp as well as by stairs
- a variance for any public non-accessible entrance if it is a new station, or if the total cost of the renovations exceeds 25% of the replacement cost of the station

## Entrance

*MAAB 26.2 The approach to such entrance(s) shall be a paved walk or ramp with a non-slip surface, uninterrupted by steps...*

*UFAS 4.14.1 Entrances required to be accessible by 4.1 shall be part of an accessible route and shall comply with 4.3. Such entrances shall be connected by an accessible route to public transportation stops, to accessible parking and passenger loading zones, and to public streets or sidewalks if available. They shall also be connected by an accessible route to all accessible spaces or elements within the building or facility. (MAAB 26.4). The approach to such entrance(s) shall be a paved walk or ramp with a non-slip surface, uninterrupted by steps...*

*MAAB 26.2 ...such entrance(s) shall have a level space 60 inches from the door, on the interior and exterior of the entrance doors. 18 inches clear floor area shall also be provided on the latch, pull side of the doors.*

*MAAB 20.3 Topography or grounds shall be graded so as to attain a level area (pitched to drain) at each entrance, and shall be paved or hard packed.*

The approach to the accessible entrance(s) should be a paved, continuous surface uninterrupted by steps. When level changes occur immediately outside of an entrance, a ramp and stairs can be used in conjunction. Ramps should never entirely replace steps because some people who walk with difficulty prefer steps and are safer using them. (For design details, see "Ramps," page 71, and "Stairs," page 75.)

When a ramp is required, an interior location is preferable to an exterior one because it is protected from the weather. Covered exterior ramps reduce the risk of people falling on an accumulation of ice and snow, and reduce the need for removal of snow and ice. It should be decided for each site individually whether or not ramps should be covered, as there are cases where ramp roofs are required, and cases where it may be preferable to leave ramps uncovered. (See "Accessible Route," page 34.) Complete enclosure of exterior ramps is not recommended because of safety issues and the excessive heat that can build up in an enclosure.

Wheelchair lifts are an unacceptable way to achieve vertical circulation to an MBTA station. At any facility, it is preferable to find an alternative accessible entrance to the station than to require disabled people to use a lift to get to the door.

There should be a level area for a distance of 60 inches outside the door so that people using wheelchairs or crutches have a stable position as they pull the door. There should be an 18 inch clear space on the latch pull side of the entrance door. Where drainage is needed, a slope of 1/8 inch per foot is acceptable.

**Level  
Changes**

**Entrance  
Landing**



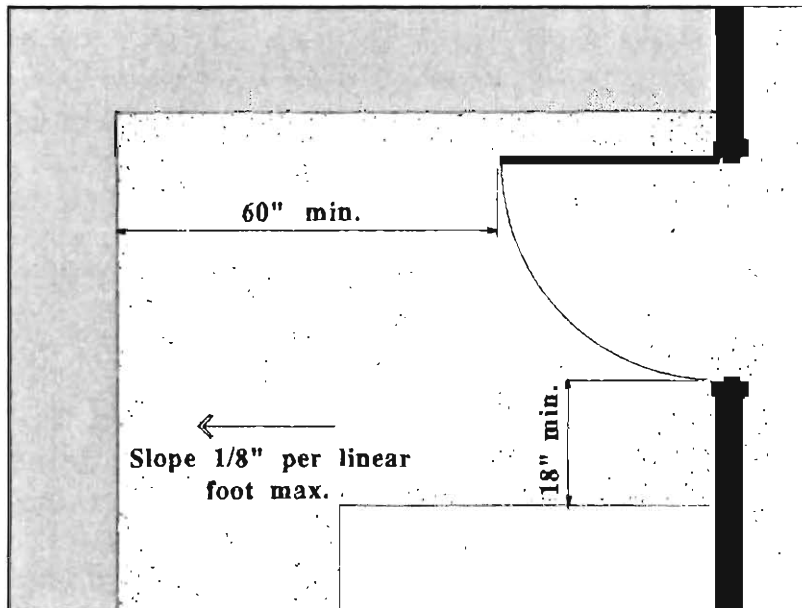

**Entrance Landing**

Provide a canopy or some form of weather protection at the main entrance to shield people from inclement weather. This will also help keep the entrance approach free of puddles, ice, and snow.

**Signage**

Any entrance which is not accessible must have a sign clearly indicating the location of the accessible entrance. The sign should display the International Symbol of Accessibility and an arrow in the direction of the accessible entrance. When placing this sign, be careful to use the perspective of a person seated in a wheelchair. The sign should be tactile and should be placed, if possible, between 45 and 60 inches above the finished floor or ground to the right of the doorway, so that people in wheelchairs as well as visually impaired people can find it.

*MAAB 26.7 Identification: Any entrance of a facility not accessible by persons in wheelchairs shall have a sign clearly indicating the location of the accessible entrance.*

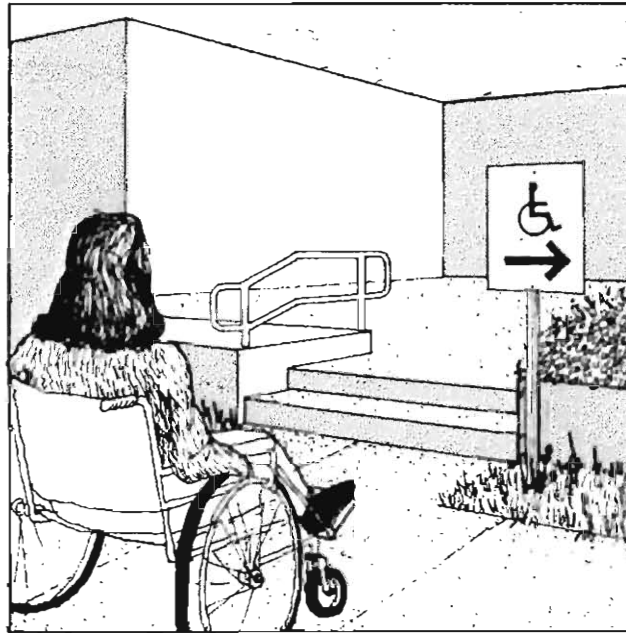

Sign Indicating Location  
of Accessible Entrance

*MAAB 26.3 Vestibules: Between any two hinged or pivoted doors, there shall be a minimum of 48 inches plus the width of any door swinging into the space.*

*UFAS 4.13.7 ...Doors in a series shall swing either in the same direction or away from the space between the doors.*

Vestibule doors that are too close together can trap a person who uses a wheelchair because there is not enough room for the person to pull open the second door. If vestibule doors align, there must be at least 48 inches between the swing of one door and the face of the next door. If the doors are offset at opposite corners of the vestibule, 60 inches between closed doors is enough space to maneuver a wheelchair. The state building code requires 7 feet between the doors in a means of egress.

In existing buildings, the vestibule requirement is often difficult to achieve. When the vestibule also serves as a means of fire egress, strategies such as changing the direction of the door swing may not be a solution. Where possible, enlarge the existing vestibule to create enough space between the two doors.

If the vestibule cannot be enlarged, a small 48 inch vestibule can be made passable by replacing the interior door with a double-acting door so that a person entering can simply push the second door open. It also allows a person exiting the building in an emergency to push open both doors. In such a case, a building code variance would be necessary.

## Vestibules

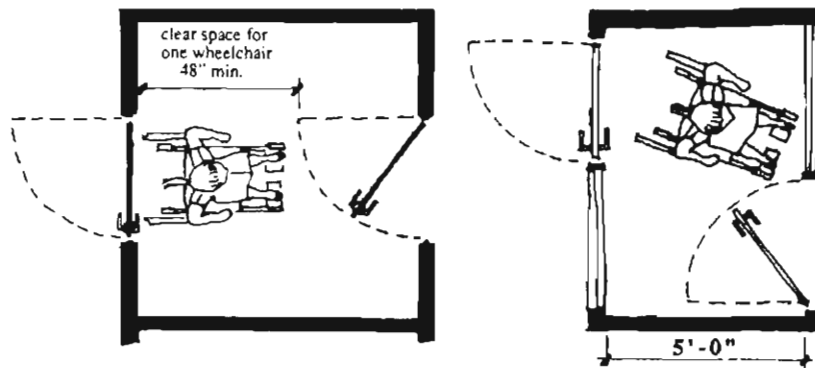

Vestibule Solutions

**Entry Doors** When pivot doors are used, particular attention must be given to the effective clear opening of the door. (See "Doors and Doorways," page 96.)

If the "all-glass look" is used for doors and adjacent windows, people with visual impairments may have difficulty finding the door when it is detailed to match the adjacent windows. Glass doors should be visually distinguishable from glass walls.

Entry doors which are heavy to push or pull can impede people using wheelchairs, walkers, or crutches and those who lack stamina. (For design details, see "Doors and Doorways," page 95.)

**Automatic  
Doors**

Automatic doors, although expensive, are particularly beneficial when there is a lot of traffic, or when existing doors do not meet the code. Use them, for example, when an existing door is too heavy for some people to open, when an 18 inch clear space on the latch side of the door is not available, or when the vestibule is too small for a person in a wheelchair to manually open the door. Doors that slide sideways are preferable to those that swing because they are less likely to hit people.

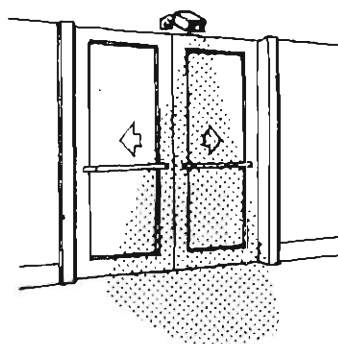

**Photoelectric Cell**

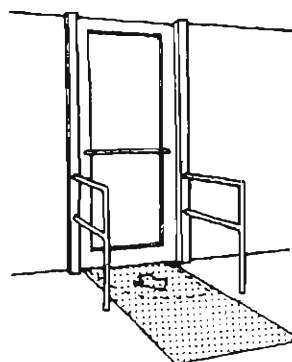

**Floor Pressure Pad**

Place activation switches along the path of travel where they will be easy to reach as one approaches the door.

If power-operated doors are used for two-way traffic, the activating mats, as well as the guard rails, should extend well beyond the door swing to prevent people from being hit by the opening door.

Revolving entrance doors are not used at MBTA facilities.

---

SITE

---

ENTRANCE

---

FARE COLLECTION

Schematic Fare Collection Design ■

Approach to Fare Collection ■

Fare Collection Booth ■

Accessible Gates ■

Token, Ticket and Coin Change Machines ■

---

VERTICAL CIRCULATION

---

HORIZONTAL CIRCULATION

---

PLATFORM

---

INTERIOR STATION ELEMENTS

---

TOILET ROOMS

---

## Schematic Fare Collection Design

An accessible fare collection and turnstile system must accommodate all people including those who walk with difficulty, use wheelchairs, or push strollers. All subway riders must be able to follow a clear and unobstructed path to the fare booth, make a transaction with the collector, insert a token or pass, and proceed through the gate. People must be able to communicate with the primary fare collection agent in order to make an exchange or receive information.

The fare collection area should be located along a path of travel suggested by the surrounding elements. If considered early in the design process, the orientation of the room and the pattern of the structural elements can suggest the direction of travel. These clues help people with visual impairments find their way.

### Location

Whenever possible, the fare collection booth should be located within the rider's sight line upon entering the headhouse or reaching the fare collection level. Wayfinding will be simpler for everyone and the signage will be less complex if one can see the fare collection booth ahead. This is especially important for visually impaired riders who may not be able to read signs, but can distinguish large shapes like the fare collection booth if it stands out from its surroundings. If the fare collector's booth cannot be seen upon reaching the fare collection level, then, to the extent possible, limit the direction decisions so that a single obvious path or travel leads from the stairs, ramps, or elevator to the fare collection area.

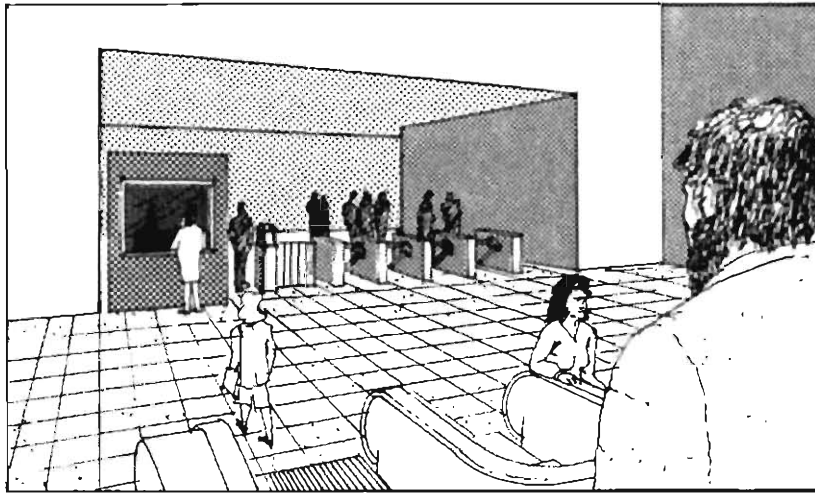

**Fare Collection Booth Visible Upon Arrival  
at the Fare Collection Level**

The horizontal distance from the entrances to the fare collection area should be as short as possible to minimize the stress for a person with an endurance problem and/or a mobility impairment. It is particularly important for an elevator-equipped entrance to drop people off near the fare collection booth.

### **Schematic Design Summary**

The schematic design should provide:

- a simple path of travel which makes wayfinding easy
- wheelchair maneuvering space at the fare collection booth
- a 36 inch wide gate adjacent to turnstiles

## Approach to Fare Collection

*UFAS 4.3.8 Changes in levels along an accessible route shall comply with 4.5.2*

*UFAS 4.5.2 Changes in level up to 1/4 inch may be vertical and without edge treatment. Changes in level between 1/4 inch and 1/2 inch shall be beveled with a slope no greater than 1:2. Changes in level greater than 1/2 inch shall be accomplished by means of a ramp that complies with 4.7 or 4.8.*

*MAAB 18.3.3 Within the terminal there shall be seating at intervals not to exceed 250 feet.*

All riders should find the path to the fare collection area clear and uninterrupted by steps or other obstructions. The floor surface of this path must be non-skid with no barriers such as bumps, thresholds or level changes greater than 1/2 inch. Changes in level between 1/4 inch and 1/2 inch must be beveled with a slope of 1:2 or less.

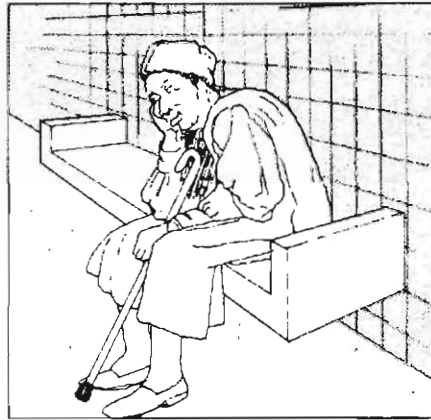

**Seating Must Be Provided Every 250 Feet**

Seating must be provided within every 250 feet. Seats should be placed in both the paid and unpaid areas of the station. Although one may not expect a rider to sit except when waiting for a train, many riders (especially elderly people or people with back problems) will appreciate the opportunity to rest at intervals. Seats in the vicinity of the fare collection

booth provide a good resting place en route to the train. Make sure seating placement does not impede the route of travel. Arm rests at the ends of seats make it easier for people to pull themselves to a standing position.

### Resting Places



## Fare Collection Booth

### Clear Floor Space

The floor space in front of the fare collection window must be at least 30 x 48 inches with the long side against the booth. This allows a person using a wheelchair to pull up parallel to the counter.

Once the fare transaction is made, a person using a wheelchair will need to turn and proceed to the gate. If the space configuration requires the person to turn around before proceeding, allow 60 x 60 inches wherever the turn is to be made.

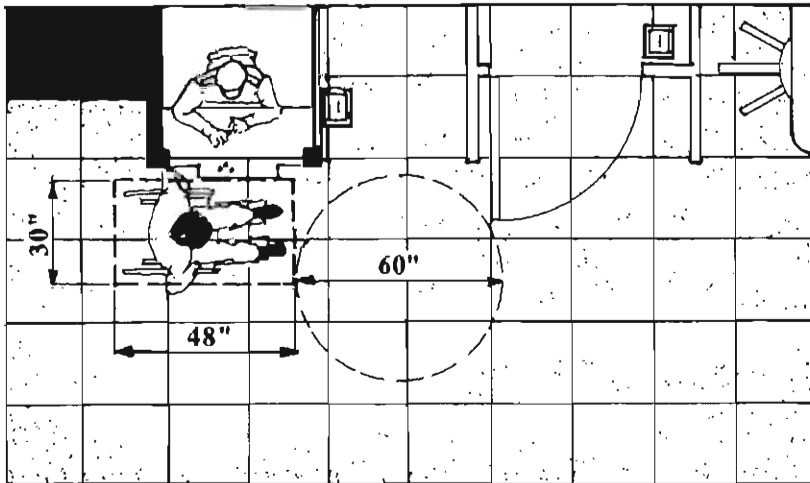

60 x 60 Inch Turning Space Is Necessary

### Counter and Window

The fare collection counter and tray should be a maximum of 36 inches from the floor. At that height, a person seated in a wheelchair can pull up to the counter and still see the collector behind it. Clear glass should be used to facilitate communication. A hearing impaired person may need to speechread, and a person with limited sight will be better able to see the collector's actions.

*UFAS 4.2.4.1 The minimum clear floor or ground space required to accommodate a single, stationary wheelchair occupant is 30 inches by 48 inches. The minimum clear floor or ground space for wheelchairs may be positioned for forward or parallel approach to an object. Clear floor or ground space for wheelchairs may be part of the knee space required under some objects.*

*UFAS 4.2.3 The space required for a wheelchair to make a 180-degree turn is a clear space of 60 inches diameter or a T-shaped space.*

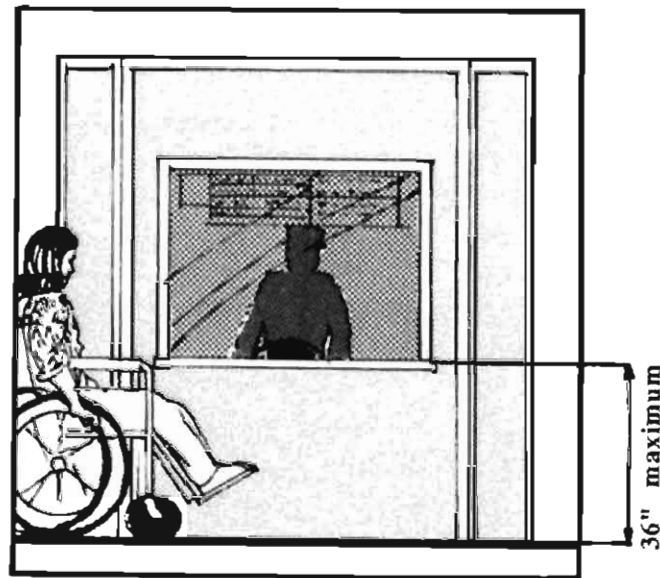

Fare Collection Change Tray

Hearing impaired and visually impaired people should have means of communicating with the fare collector to ask questions or get directions. In particular, a visually impaired person may need to ask which way to turn next. Because it is difficult to hear through the window, many people are forced to speechread the fare collector's answer to a question. But this is not very effective and of course is not an option at all for a visually impaired person. Therefore, an electronic speak-thru must be provided on any new fare collector's booth.

**Speak-thru**

When placing the fare collector's booth, consider the sightlines to the access gate. Ideally the collector will be able to see a person on either side of the access gate. This is especially important since, in most cases, the collector must unlock the access gate.

**Booth Orientation**

UFAS requires employee areas to be accessible. Therefore, when new fare collection booths are purchased, accessibility features should be incorporated. The basic requirements for an accessible booth are adequate clear space, an accessible door, and accessible level changes or no level changes at all. Not every fare collector's booth can be made accessible. In some cases the space may be too tight. But when possible, a standard for accessibility should be established.

**Booth Interior**

The entrance to a booth should have no abrupt level changes greater than 1/2 inch. Level changes between 1/4 and 1/2 inch should be beveled with a slope of 1:2. If the floor of the booth is raised from the floor of the station, a ramp can be used to bridge the transition. Be sure to leave a 60 x 60 inch level clear space outside the door so that someone can open it without rolling away. (See "Ramps," page 71.)

The door should comply with UFAS 4.13 and MAAB 27. (See "Doors and Doorways," page 95.)

Inside the booth, clear space is necessary to accommodate a wheelchair. If a turn must be made, a 60 x 60 inch space is needed. A wheelchair at rest occupies a space of 30 x 48 inches. Foot pedals should be avoided because many people who have sustained spinal injuries cannot use their feet. The MBTA is developing accessible prototype booth designs to accommodate employees who use wheelchairs. This information will be provided as an addendum to the *Guide to Access*.

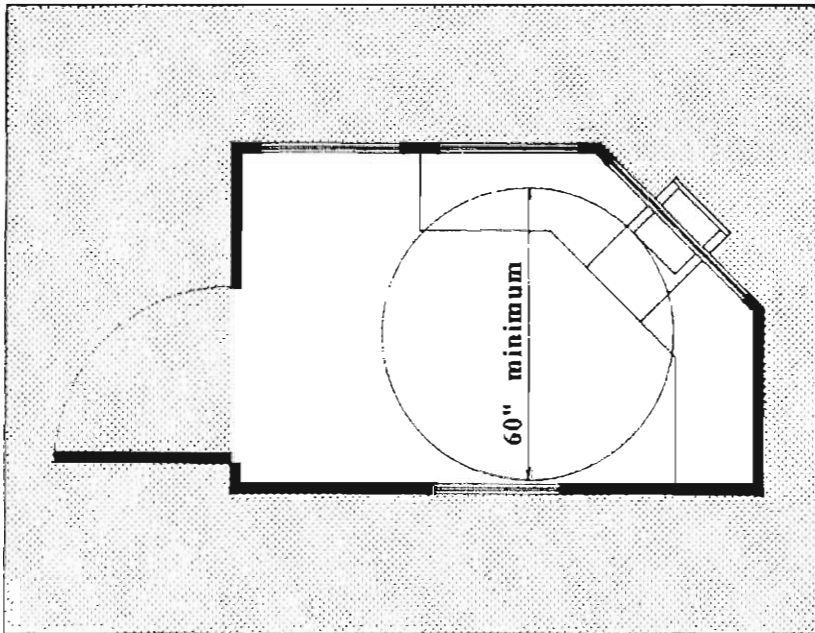

Fare Collection Booth Interior

If the collector prefers to transfer onto a chair, a swivel chair which can lock into place would be helpful. Firm back support and removable armrests would aid in transferring to and in stabilizing in the chair. These types of accommodations can be made on an as-needed basis.

The control panel of all fare collection booths should be equipped with a prominently located light which flashes when someone pushes the button at the accessible gate. A release button for the accessible gate must be placed next to the light. With this system, people using the access gate will be able to get the fare collector's attention.

The fare collector should also have an alert light which signals elevator breakdowns so that he can inform a passenger if necessary.

### Fare Collector's Controls

## Accessible Gates

### Dimensions

Wherever turnstiles are used, at least one, and preferably two, accessible gates must be provided adjacent to the turnstiles. Gates should meet all of the requirements for doors so that individuals with disabilities can use the gates independently. The minimum width is 36 inches with a minimum clear opening of 34 inches, to facilitate passage for individuals using wheelchairs. A latch pull side clearance of 18 inches is also required. Code requirements for door weight and hardware must also be met.

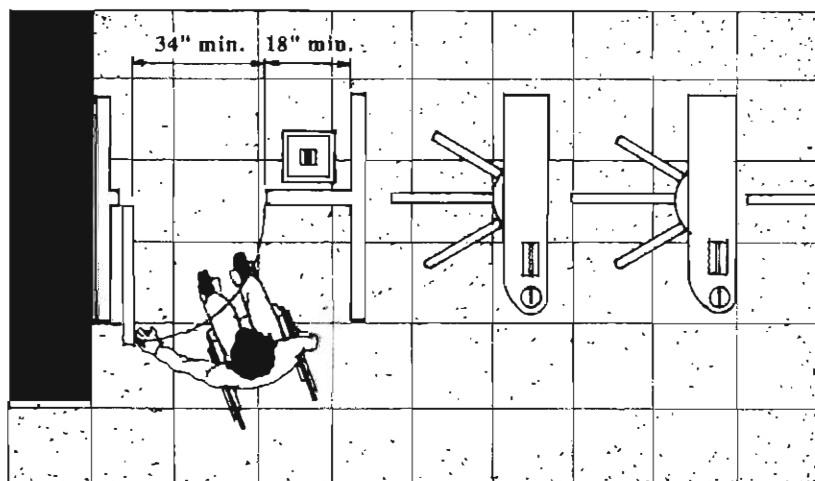

**Accessible Gate With 34 Inch Clear Opening and 18 Inch Clearance**

The International Symbol of Accessibility should be placed at the gate area on both sides of the fare collection booth.

### Fare Collector Alert

The auto-return gate should be equipped with a button on both sides which sets off a light in the fare collector's booth. This button will ensure that a rider can get the fare collector's attention when he or she arrives at the gate. The button should be located within reach of a person seated in a wheelchair between 36 and 48 inches from the floor. The button should be identified in some way so that people know what it is for.

*UFAS 4.13.2 Revolving doors or turnstiles shall not be the only means of passage at an accessible entrance or along an accessible route. An accessible gate or door shall be provided adjacent to the turnstile or revolving door and shall be so designed as to facilitate the same use pattern.*

*MAAB 18.5 At least one fare transaction area and entry/exit gate shall be accessible to the handicapped and shall be a minimum of 36 inches wide.*

## Token, Ticket, and Change Machines

Token, ticket, and coin change machines should be accessible to as many people as possible, including people using wheelchairs, people with limited hand coordination, people with limited comprehension, and people with visual impairments.

*UFAS 4.2.5 Forward Reach. If the clear floor space only allows forward approach to an object, the maximum high forward reach allowed shall be 48 inches. The minimum low forward reach is 15 inches....*

*UFAS 4.2.6 Side Reach. If the clear floor space allows parallel approach by a person in a wheelchair, the maximum high side reach allowed shall be 54 inches and the low side reach shall be no less than 9 inches above the floor....*

For people using wheelchairs, the height of the controls and the instructions are crucial. Using a parallel approach to the machine, a person seated in a wheelchair can reach up to 54 inches above the floor. However, it may be difficult to read instructions up that high. Preferably, the instructions will be located below each control where they will be easily read. If the machines are located along a corridor wall where a person is likely to roll up alongside the machine, it is safe to assume that the parallel approach will be used. However, if the machines are located perpendicular to the direction of travel, it is likely that the person will use a forward reach to the machines. In this case, the controls and instructions should be no higher than 48 inches from the floor.

**Machine  
Height**

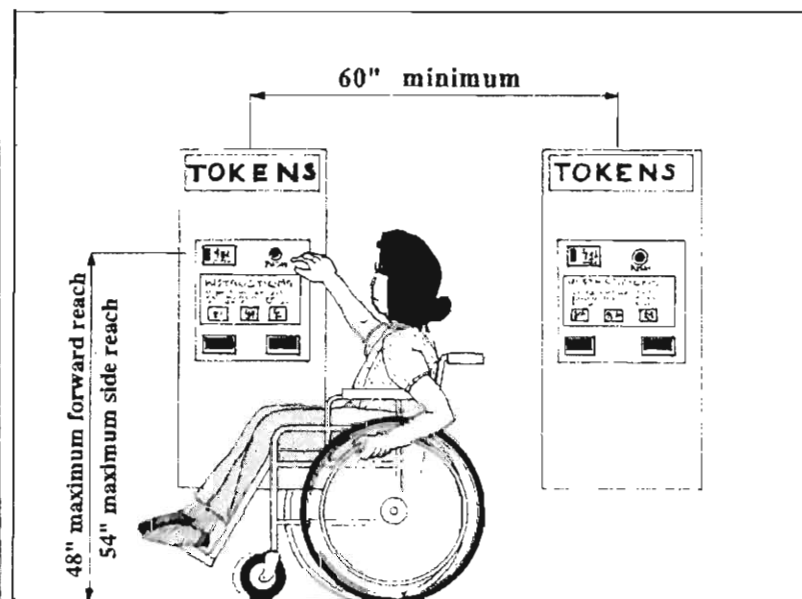

**Token/Ticket Vending Machine**

### Machine Spacing

If several machines are placed together, space them at least 60 inches apart so that a person using a wheelchair will have space to move out of the way of the person behind them and make a turn to proceed to the gate.

*UFAS 4.2.3 Wheelchair Turning Space. The space required for a wheelchair to make a 180-degree turn is a clear space of 60 inch diameter or a T-shaped space.*

### Machine Design

The instructions should be readable by a person seated in wheelchair. Therefore, instruction panels or controls should not tilt upwards towards a standing person's face. To accommodate visually impaired riders, the type size should be at least 1/2 inch high and placed on a contrasting background. Light letters on a dark background are easiest to read. For full accessibility, tactile lettering similar to the lettering found on elevator control panels could be used.

The control buttons should be large and clearly marked. Pictograph symbols are helpful for people who do not speak English and people with low comprehension. Large buttons will be easier for people with arthritis to operate. If the tokens fall into a dish where the rider will scoop them up, it is recommended that the dish be at least 3-1/2 inches wide so that people without dexterity in their individual fingers can slip their hand in and slip the tokens out.

---

SITE

---

ENTRANCE

---

FARE COLLECTION

---

**VERTICAL CIRCULATION**

**Vertical Circulation Options** ■

**Ramps** ■

**Stairs** ■

**Elevators** ■

---

**HORIZONTAL CIRCULATION**

---

PLATFORM

---

INTERIOR STATION ELEMENTS

---

TOILET ROOMS

---



## Vertical Circulation Options

*UFAS 4.3.2 (1) At least one accessible route shall connect accessible building or facility entrances with all accessible spaces and elements.*

Station levels must be connected with accessible vertical circulation. Ramps and elevators benefit more than just people using wheelchairs. Blind people, elderly people, people travelling with small children and others appreciate an accessible route which provides alternatives to stairs.

Alternative means of vertical circulation should be available for riders to use independently, rather than requiring the assistance of an attendant. Accessible vertical circulation options include ramps, elevators, inclined elevators and lifts. Situations in which each of these solutions may be appropriate are discussed below.

The main advantage to using a ramp rather than an elevator is that it is almost maintenance free. Ramps, if designed well, are more reliable than elevators. For people with strollers, wheelchairs, or luggage, ramps provide dependable access. Ramps can also handle many more people per unit of time.

### Ramps and Stairs

The main disadvantage to using a ramp is that the route of travel becomes very lengthy as the level change increases. Code requires a maximum allowable slope of 1:12. The MBTA has instituted a new policy requiring the slope of a ramp to be no steeper than 1:12.5 (8%). This is to allow for construction tolerances so that no ramp will exceed code requirements.

Ramps should be used in conjunction with stairs to make accessible level changes. While many people who use ramps cannot use stairs, the reverse is also true. Some people who walk with difficulty, particularly those using crutches or a cane, cannot accommodate their gait to a ramp's sloping surface. Therefore, ramps and stairs should supplement each other.

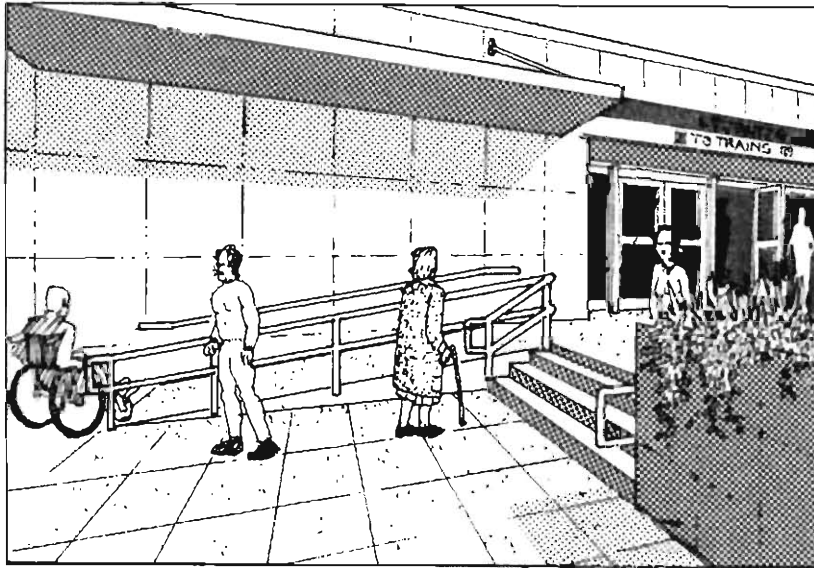

### Ramps and Stairs Supplementing Each Other

When a level change necessitates the use of a ramp, locate the ramp entrance immediately adjacent to stairs if possible so that people do not have to deviate off the pathway to find and use it.

*(For design details, see "Ramps," page 71, and "Stairs," page 75.)*

### Elevators

Elevators provide access for the broadest range of people. Not only are they accessible to people using wheelchairs, but they provide access for people who lack the stamina to use a staircase or a lengthy ramp. They are safer for visually impaired people and can simplify wayfinding if they are strategically placed.

The major disadvantage to elevators is their tendency to break down. An elevator out of order can be a complete barrier to travellers who rely on it.

The street-to-lobby elevator should drop riders off in the unpaid area of the fare collection level, just as the stairs and/or ramps do, so that no special fare collection procedure will be necessary. This way, the elevator can be unlocked and available for public use.

For security reasons, the MBTA prefers glass elevators when possible. This option should be considered in the schematic design.

Elevators should remain as close to the primary route of travel as possible. An elevator which is tucked in a distant corner will be difficult to find, especially for visually impaired riders. Remote elevators are also a security hazard.

Within and between stations, the levels as indicated on signage and on the elevator control panels should be consistent.

*(For design details, see "Elevators," page 80.)*

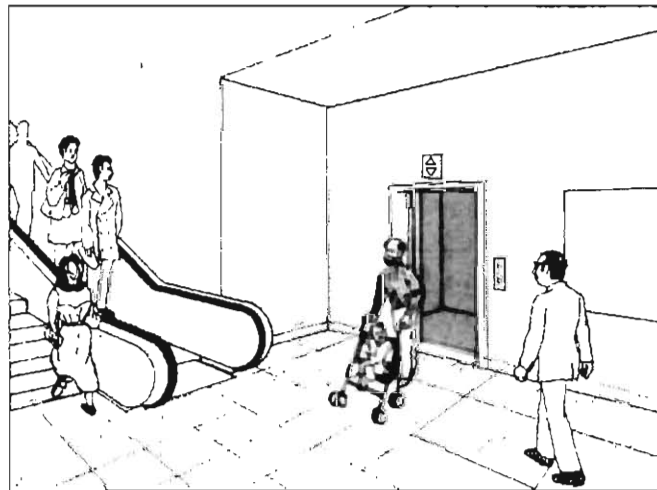

**Elevator Located Close to the Primary Route of Travel**

Inclined elevators can be used when space for a vertical elevator shaft is unavailable. Inclined elevators look and operate like standard elevators, except that they travel at an angle. Because they can be placed alongside an existing staircase, they allow riders to use the main route of travel. Use the design details given for elevators to generate specifications for

### **Inclined Elevators**

inclined elevators. Note that inclined elevators generally have two doors. The MBTA requires a control panel at each.

*(For design details, see "Elevators," page 80.)*

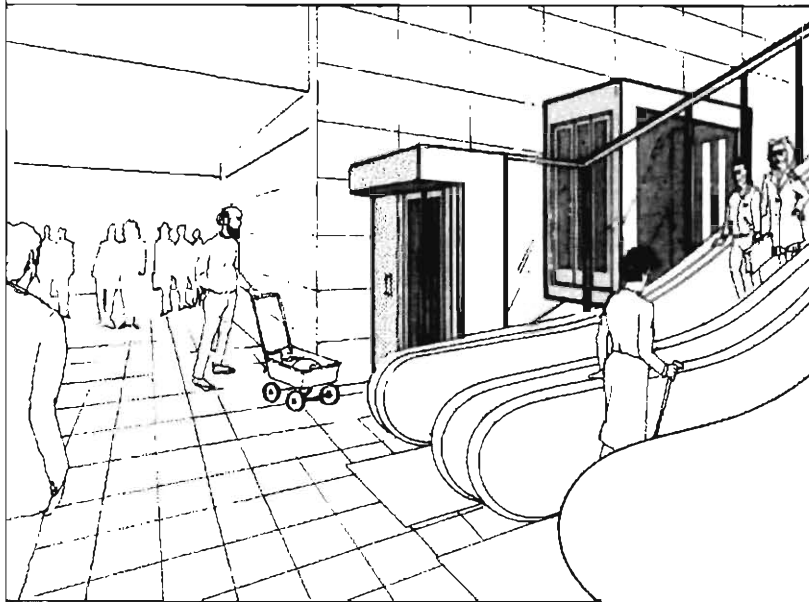

**Inclined Elevator**

### Lifts

Because a lift can handle only one person at a time, and because they are prone to vandalism, vertical platform lifts are not considered to be a desirable access solution for MBTA stations. They have been used, however, in MBTA employee facilities and are considered a viable option in that controlled setting. A variance is required from the Architectural Access Board if a lift is included in any facility.

### Schematic Design Summary: Vertical Circulation

The schematic design should provide:

- a ramp or an elevator from the entrance level to the fare collection and platform levels
- ramps or elevators which are adjacent to the main route of travel
- ramps or elevators which are visible, if possible, from the main route of travel
- an elevator which stops in the unpaid area of the fare collection level

## Ramps

*UFAS 4.8.1 Any part of an accessible route with a slope greater than 1:20 shall be considered a ramp and shall comply with 4.8. (MAAB 22.1)*

*UFAS 4.8.2 Slope and Rise. The least possible slope shall be used for any ramp. The maximum slope of a ramp in new construction shall be 1:12. The maximum rise for any run shall be 30 inches. (MAAB 25.2)*

*MAAB 25.7 Circular ramps are not acceptable, except with the approval of this Board.*

*MAAB 25.2 Slope of ramps shall not exceed one-in-twelve (1:12).*

*UFAS 4.8.2 The least possible slope shall be used for any ramp. The maximum slope of a ramp in new construction shall be 1:12.*

A ramp is defined as a pathway with a slope greater than 1:20. (Note schematic issues regarding ramps in above section.)

When a ramp must be used, locate it so that people do not have to deviate off the pathway to find and use it. Try to locate the foot of the ramp immediately adjacent to stairs.

The maximum allowable slope is 1 foot of rise to 12.5 feet of run. (See discussion of ramp slope in "Ramps and Stairs," page 67.) However, many wheelchair users have difficulty going up a ramp this steep. Where ramps must be used, the slope should be minimized. Depending on the context and available space, the slope may range from 1:12.5 to 1:20.

**Ramp Location**

**Ramp Slope**

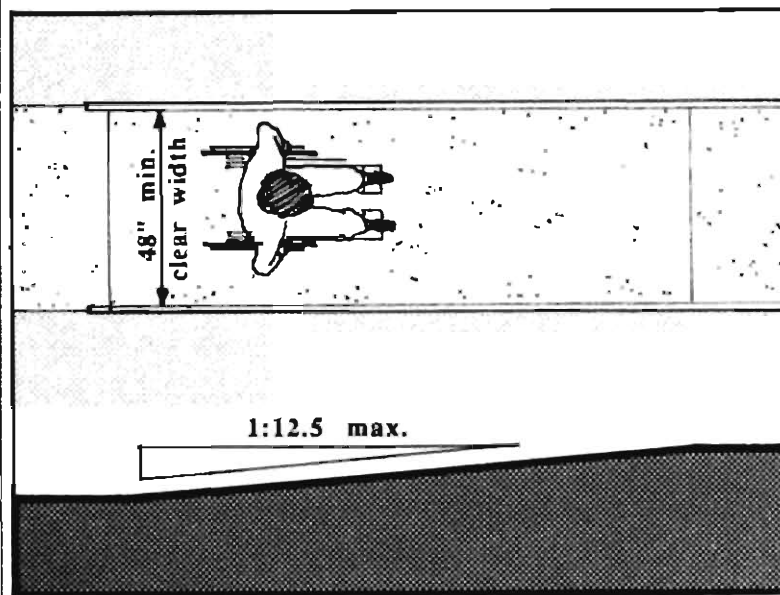

**Minimize Slope of Ramps**

# Ramps

**Ramp Width** Ramp width must be at least 48 inches, measured from the inside of one railing to the inside of the opposite railing. This width allows a person in a wheelchair and a person walking to pass each other.

**Ramp Landings** Landings are essential to people with mobility impairments or stamina limitations. Ramps can be any length as long as they include adequate landings for people to rest. Landings are required every 30 feet of run. Landings must also be provided at the top and bottom of the ramp and at every change of direction.

The ramp landing must be as wide as the ramp leading to it and a minimum of 60 inches long. Where the ramp changes direction, the landing must be at least 60 x 60 inches.

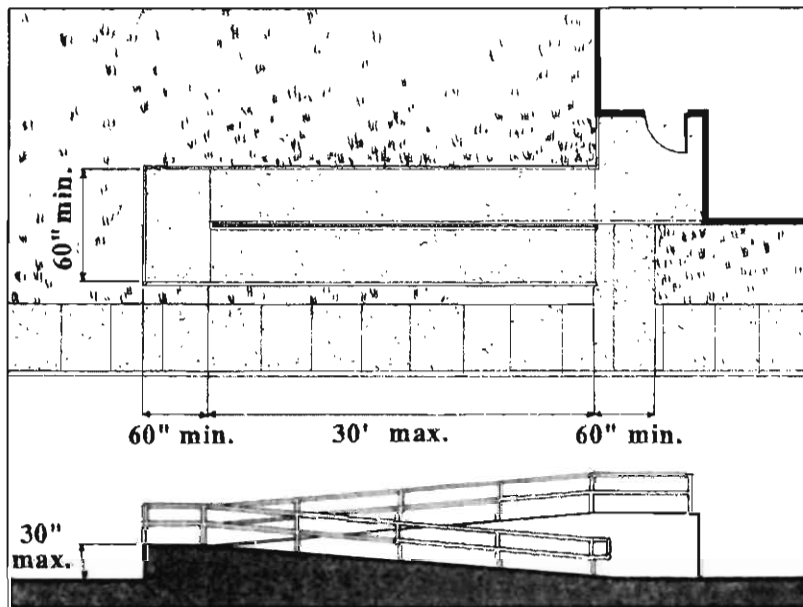

**Ramp Landings**

Landings which are also an approach space for a door should be at least 60 x 60 inches. Intermediate landings need to be at least as wide as the ramp leading to it, and 60 inches long. If the ramp is very long, such as a ramp at an overpass, consider placing benches at the switchbacks to give people a chance to rest.

*MAAB 25.3 Width of ramps shall not be less than 48 inches minimum clearance, measured at the railings.*

*UFAS 4.8.2 The maximum rise for any run shall be 30 inches.*

*UFAS 4.8.4 (1) The landing shall be at least as wide as the ramp run leading to it. (2) The landing length shall be a minimum of 60 inches clear. (3) If ramps change direction at landings, the minimum landing size shall be 60 inches by 60 inches. (4) If a doorway is located at a landing, then the area in front of the doorway shall comply with 4.13.6.*

MAAB 25.5 Ramps shall have a surface that is non-slip..

Ramp surfaces need to be slip resistant. This can be achieved by using broom-finish concrete, adding carborundum chips to the concrete, applying paint with sand in it, or attaching non-slip strips to the ramp surface. Surface treatment is especially important on exterior ramps which may become slippery in wet or freezing weather.

**Ramp Surface**

MAAB 25.4 Handrails shall be set on both sides of ramps in pairs, one at a height of 34 inches, and a lower one at a height of 19 inches, measured vertically from the surface of the ramp. Handrails shall extend at least 12 inches beyond the top and bottom of the ramp, but need not so extend if it would cause a safety hazard. ... [The handgrip] shall be round or oval in cross-section, and shall have a smooth surface with no sharp corners. A clearance of 1-1/2 inches shall exist between a wall and the wall rail.

Some outdoor ramps are required to be roofed; other cases should be decided individually. (See "Accessible Route," page 34.) Where ramps are not roofed, it is helpful to orient them toward the south sun to promote the melting of ice and snow.

**Ramp Roofs**

As with stairs, handrails are required on both sides of ramps to help people who have strength on only one side of their body. They may need the left handrail on their way up, and the right rail coming down.

**Handrails**

Handrails are required at two levels to be useful to people walking and to people in wheelchairs who may use the lower rail to pull themselves up the ramp. The upper handrail should be at 34 inches, and the lower handrail at 19 inches. These heights are measured vertically from the surface of the ramp to the top of the railing.

**Handrail Mounting**

UFAS 4.8.5 If handrails are not continuous, they shall extend at least 12 inches beyond the top and bottom of the ramp segment and shall be parallel with the floor or ground surface.

The clearance between handrails and walls must be exactly 1-1/2 inches. This clearance allows someone to get their hand around the rail, but does not allow an arm to slip through so that it could be broken during a tumble.

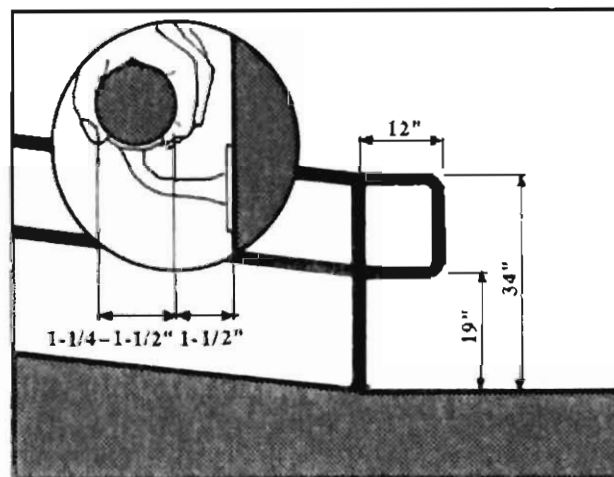

**Ramp Handrail With Extensions**

## Handrail Extensions

Extend both handrails 12 inches horizontally beyond the top and bottom edge of the ramp to provide support for people with balance problems.

## Handrail Shape

People need smooth handrails that they can hang on to. For this reason, handrails must have an outside diameter of between 1-1/4 and 1-1/2 inches and be round or oval in cross section.

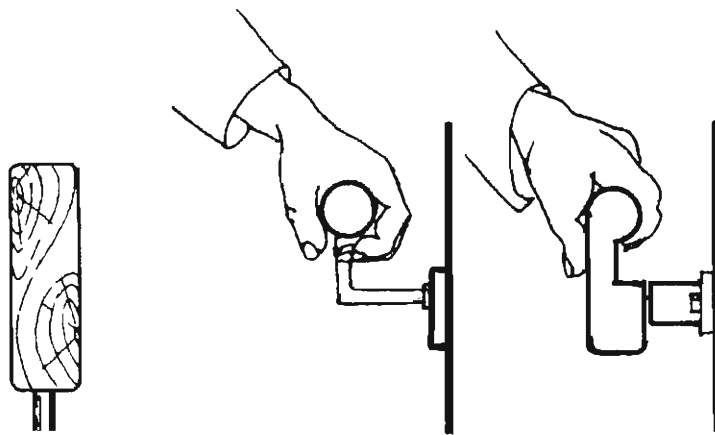

Unacceptable Handrail

Acceptable Handrails

## Edge Protection

If the ramp drops off at the side, UFAS requires some sort of edge protection to prevent a wheelchair's small front wheels, a crutch, or a cane tip from going over the edge. Solid walls on each side of the ramp with wall-mounted handrails are the safest edge protection, since a wheelchair gone off course will be guided down the ramp and not collide with the railing. Railings are another edge protection option listed in UFAS. Current opinion is that the additional railing at 19 inches required by MAAB will suffice for edge protection. 19 inches is within a range detectable by cane, and a person seated in a wheelchair probably could not drop the front wheel over the edge because his or her legs would hit the lower rail first.

*UFAS 4.26.2 Size and Spacing of Grab Bars and Handrails. The diameter or width of the gripping surface of a handrail or grab bar shall be 1-1/4 inch to 1-1/2 inch, or the shape shall provide an equivalent gripping surface.*

*UFAS 4.8.7 Edge Protection. Ramps and landings with drop-offs shall have curbs, walls, railings, or projecting surfaces that prevent people from slipping off the ramp. Curbs shall be a minimum of 2 inches high.*



## Stairs

Although stairs must not be the only way for people to move between levels of a building, many people with disabilities can use stairs. Safe stair design is important to everyone. MAAB stair requirements apply to all staircases, but UFAS's stair requirements apply only to staircases which connect levels *not* connected by an elevator. Since elevators are becoming standard at MBTA renovations, it is unlikely that UFAS will apply. If, however, you are designing a staircase which connects levels *not* connected by an elevator, incorporate the UFAS regulations which are noted in the following design details.

The sloping underside of freestanding staircases and escalators are hazardous to people with visual impairments. Without detectable warnings, people may run into the stairs and injure their heads. Install permanent planters or walls below the staircase to prevent people from walking under them.

### Freestanding Staircases and Escalators



Stairs that descend in circular spaces can be hazardous to a blind person who may not be able to locate them with a white cane.



A planter below the stair provides a locatable barrier for a blind person, and prevents him from banging his head on the underside of the stair.

## Treads and Risers

Treads should be no less than 11 inches deep. This dimension allows people to place their whole foot securely on the step. Riser height should be no more than 7 inches. Steeper stairs can be too challenging for people with stamina problems caused by respiratory or heart ailments.

Stair treads with adequate traction prevent people from slipping. Appropriate non-slip surfaces include abrasive coatings, non-slip strips, rubber treads, and broom-finish concrete.

*UFAS 4.9.2 On any given flight of stairs, all steps shall have uniform riser heights and uniform tread widths. Stair treads shall be no less than 11 in wide, measured from riser to riser.*

*MAAB 28.6 Stair treads shall have a non-slip surface, and only a non-slip finish material may be applied.*

## Open Risers

Because they are dangerous, stairs with open risers are not permitted. Both feet and canes can slip through the openings and get trapped between the treads. When renovating an open riser staircase, a riser can be added to the back of the stairs to solve the problem.

*MAAB 28.2...Open risers are not permitted.*

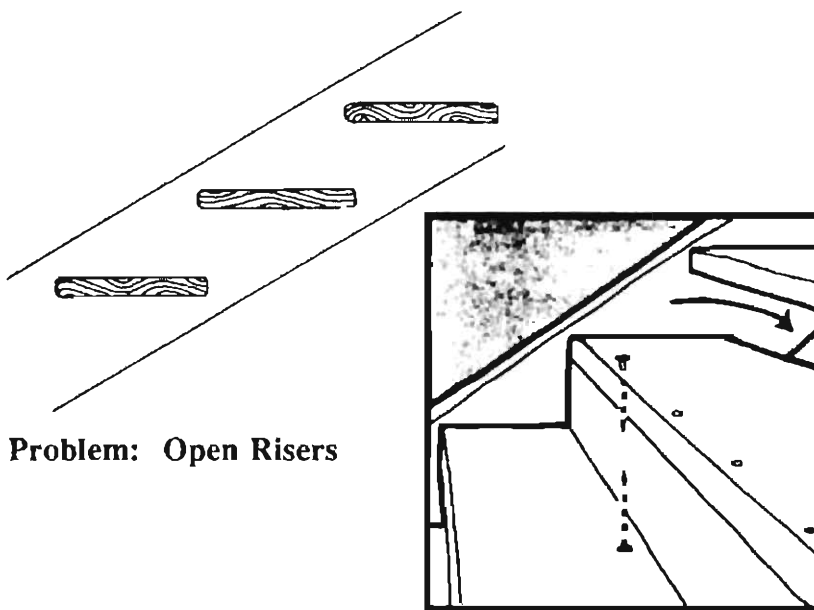

**Problem: Open Risers**

**Solution**

## Nosings

The nosing—the part of the tread that overhangs the riser—is particularly dangerous for people with braces or prostheses. Because they tend to have little flexibility in their ankles, they may catch their toes and trip on projecting nosings. To prevent this hazard, slope the riser at 70 degrees or greater to meet the front edge of the tread. Existing stairs with projecting nosings can be modified by anchoring a sloping filler piece to the riser face.

*MAAB 28.2 Such stairs shall be constructed without abrupt projection of tread nosings. Risers may slope no more than one and 1/14 inches from the horizontal projection, and the angle which the riser makes with the tread shall not be less than 70 degrees.*

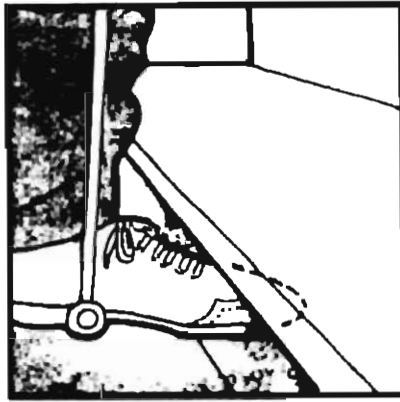

**Problem: Protruding Nosings**

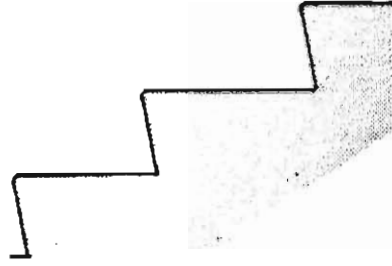

**Solution**

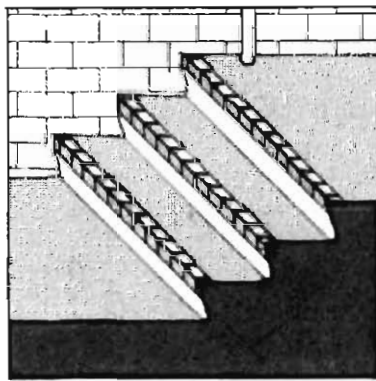

**Textured Flooring on Step Edges**

Ideally, step edges should contrast in color value from the treads, helping people with partial sight to judge the tread depth. Contrasting colors on step edges do prevent accidents. Consider ribbed rubber flooring with a contrasting edge or, for concrete stairs, a metal edge strip painted or enamelled in a bright color.

**Step Edges**

If step edges cannot be distinguished from the rest of the tread, consider painting the stair stringers in a contrasting color. This helps people judge tread depth and riser height.

*MAAB 28.3 Handrails shall be set on both sides of such stairs at a height of 34 inches above the intersection of tread and riser.*

Handrails give essential support and guidance to stair users. Rails are required on both sides of the stairs.

**Handrail Location**

Mount handrails 34 inches measured to the top of the rail above the intersection of the tread and the riser. The MBTA also recommends a second handrail at 19 inches for children.

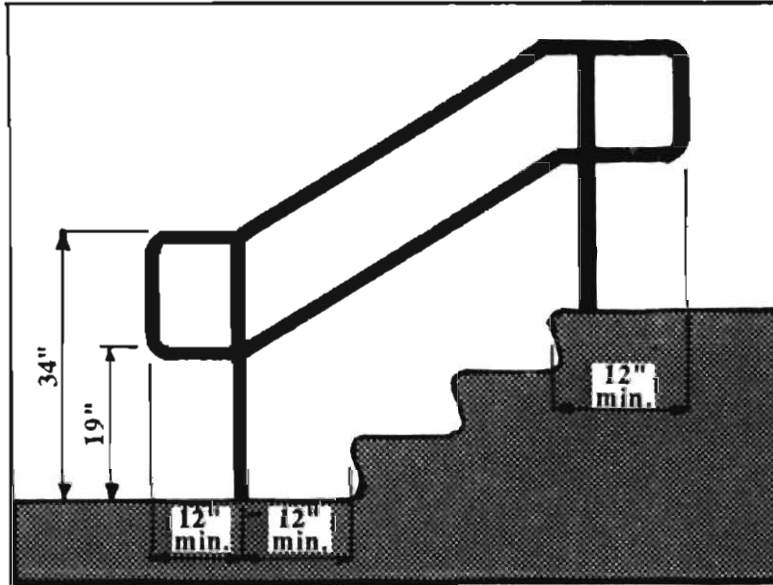

34 Inch and 19 Inch Handrail With Extensions

**Handrail Extension**

Extending handrails horizontally beyond the top and bottom treads aids people who need to stabilize themselves approaching and leaving the stairs. This extension also alerts visually impaired people that the stairway is beginning or ending.

Ideally, handrails should be continuous at landings. This provides a continuous guide for visually impaired people.

On switchback stairs handrail extensions are not required between the two flights if they would impede travel or create a hazard on the landing.

*MAAB 28.3 ...Wall rails on each set of such stairs shall extend at least 12 inches beyond the top and bottom riser at a height of 34 inches above the floor or landing, but need not so extend if it would cause a safety hazard or if space does not permit.*

*UFAS 4.9.4 (2) At the top, the handrail extension shall be parallel with the floor or ground surface. At the bottom, the handrail shall continue to slope for a distance of the width of one tread from the bottom riser; the remainder of the extension shall be horizontal.*

## Handrail Design

*UFAS 4.26.2 The diameter or width of the gripping surfaces of a handrail or grab bar shall be 1-1/4 inches to 1-1/2 inches, or the shape shall provide an equivalent gripping surface.*

*MAAB 28.5 Clearance between a wall and its wall rail shall be 1-1/2 inches.*

*UFAS 4.9.4 (4) Gripping surfaces shall be uninterrupted by newel posts, other construction elements, or obstructions.*

*UFAS 4.9.4 (6) Ends of the handrails shall be either rounded or returned smoothly to floor, wall, or post.*

*UFAS 4.9.4 (7) Handrails shall not rotate within their fittings.*

To allow people a firm grasp, handrails must have an outside diameter of between 1-1/4 inches and 1-1/2 inches and be round or oval in cross section. The clearance of 1-1/2 inches between handrails and walls prevents an arm getting caught between the rail and the wall during a tumble.

Handrails should be securely installed so that they do not rotate within their fittings. The ends of the handrails must either be rounded or must return smoothly to the floor, wall, or post.

When handrails contrast in color with the materials around them they help people with sight impairments locate the handrail and assess the length of the stairs.

The gripping surface of a handrail must not have protrusions, such as newel posts or other construction elements which project through the railing, which interrupt the smooth passage of a hand down the handrail.

## Elevators

Design details for elevators require a careful look at three codes: MAAB, UFAS, and the State Elevator Code.

### Cab Size

The State Elevator Code, Section 17.40, has special requirements for all *new* structures with two or more floors. Passenger elevators in these facilities must have cab sizes large enough to accommodate a standard stretcher. Exemptions may be allowed in facilities where adequate alternate egress is present by means of proximate, wide stairs or vehicle access to each level. Section 17.40 requires a minimum clear cab size of 54 x 80 inches with a 42 inch door opening. These dimensions are as large as or larger than those required by UFAS or MAAB. If the Elevator Code does not apply (in some new stations and in all renovated stations), the requirements of UFAS and MAAB must be followed.

UFAS requires a minimum wall-to-wall elevator cab size of 51 x 68 inches if the door is off-center, and 51 x 80 inches if the door is centered. These dimensions allow a person in a wheelchair to maneuver and make room for others entering the elevator. In an existing station with severe structural limitations, UFAS requires the elevator to be as close to its regular standard as possible. In no case should the cab size fall below the MAAB standard of 54 x 54 inches. Both UFAS and MAAB requires a 36 inch wide door.

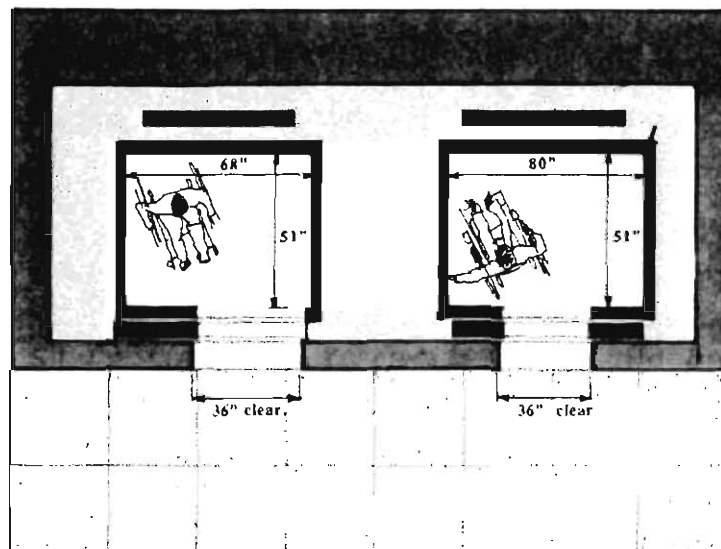

UFAS Elevator Cab Dimensions

*MAAB 35.1 Buildings having two (2) levels shall provide a ramp or elevator to each level; buildings having more than two levels shall provide elevator access to each level.*

*UFAS 4.10.9 Floor Plan of Elevator Cars. The floor area of elevator cars shall provide space for wheelchair users to enter the car, maneuver within reach of controls, and exit from the car. Acceptable door opening and inside dimensions shall be as shown....*

*MAAB 35.4 Car size measured from wall-to-wall and wall-to-door shall not be less than 54 inches by 54 inches...*

## Placement of Controls

## Two-Door Cabs

*UFAS 4.10.9 The floor area of elevator cars shall provide space for wheelchair users to enter the car, maneuver within reach of controls, and exit from the car.*

The elevator cab needs to be designed so that a person using a wheelchair can reach the controls. One way to achieve this is to design a cab large enough so that the wheelchair user can maneuver. A wheelchair user facing the rear of the cab can reach and operate the controls more easily if the controls are mounted on a side wall.

In some cases, the overall station design makes it impossible to install a standard, one-door cab. In these cases a two-door cab may be substituted. The codes do not address elevators with two-door cabs. The optimal elevator configuration from an access standpoint is two doors opposite each other, so a wheelchair user can enter and exit the cab without changing direction. However, an elevator with two doors at right angles to each other is also acceptable. Minimum code dimensions should be observed to insure that any configuration will allow sufficient maneuvering area. In some cases, one or more of the three responsible agencies may need to be consulted to assure conformance with the intent of the code.

Whenever there are two doors, the MBTA requires a control panel at each.

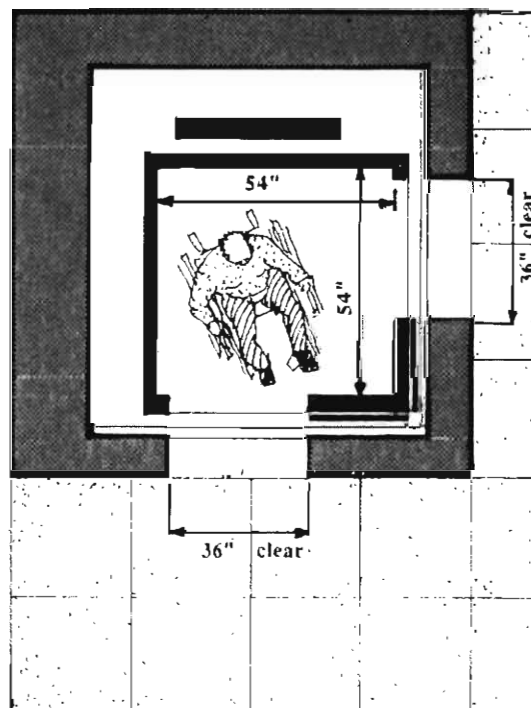

**Minimum Dimensions for Two-Door Cab With Doors at Right Angles**

## Handrail

Install a handrail on at least one wall to steady people with balance problems.

## Lighting

Lighting must be sufficient for occupants to read the letters and numbers next to the car control buttons. UFAS requires an illumination level of at least 5 footcandles.

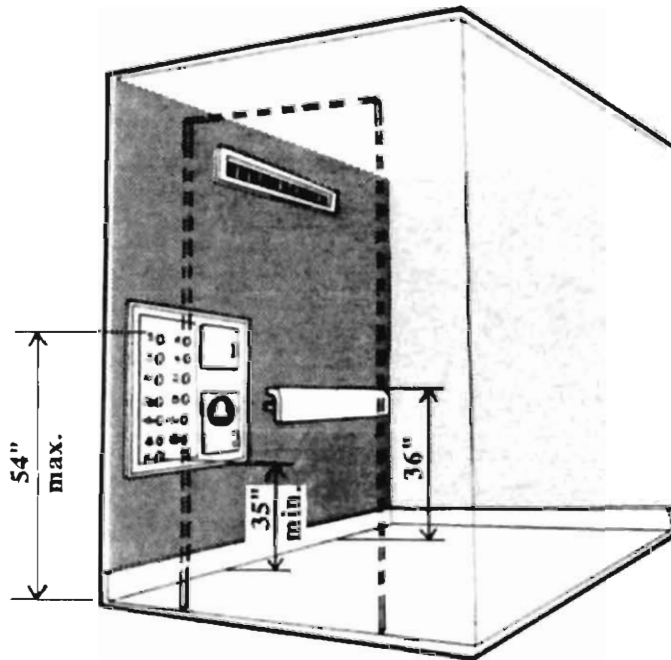

**Elevator Control Panel and Handrail**

## Control Panel

The control panel inside the elevator cab needs to be within reach of people in wheelchairs, children, and short people, but high enough to be convenient for tall people. All the buttons should fall within 35 inches to 48 inches of the floor. Be sure the emergency buttons and the emergency telephone are located at the bottom of the panel where they can be easily reached.

*MAAB 35.10 Handrails shall be located on at least one wall in every elevator between 32 to 36 inches above the car floor, with a 1-1/2 inch clearance from the wall.*

*UFAS 4.10.11 Illumination Levels. The level of illumination at the car controls, platform and car threshold and landing sill shall be at least 5 footcandles.*

*UFAS 4.10.12 (3) All floor buttons shall be no higher than 48 inches, unless there is a substantial increase in cost, in which case the maximum mounting height may be increased to 54 inches above the floor. Emergency controls, including the emergency alarm and emergency stop, shall be grouped at the bottom of the panel and shall have their centerlines no less than 35 inches above the floor.*

*MAAB 35.12 Where a service location is maintained in a building, a two-way communication system shall be provided between each elevator and that location. The elevator component shall be placed at a maximum height of 48 inches above the car floor.*



## Button Design

MAAB 35.5 ...Floor numbers, letters or symbols shall be at least 1/2 inch high and raised three-hundredths (.03) of an inch, on contrasting background, and located to the left of floor buttons, not on the buttons. Permanent adhesive plates are acceptable...Braille letters and numbers may be used in addition to, but not instead of, large raised characters.

UFAS 4.10.12 Elevator control panels shall have the following features: (1) Buttons. All control buttons shall be at least 3/4 inches in their smallest dimension. They may be raised or flush. (2) Tactile and Visual Control Indicators. All control buttons shall be designated by raised alphabet characters for letters, Arabic characters for numerals, or as shown in ANSI... The call button for the main entry floor shall be designated by a raised star at the left of the floor designation...

For people without fine finger control, projecting buttons with a concave scoop are easier to use than flush buttons. Metal buttons should be specified because plastic ones are too easily damaged. Heat-sensitive control buttons should not be used because people using hand wands or a prosthesis will not be able to operate them.

Raised floor numbers should be located *beside* the button so that touch-sensitive buttons are not inadvertently activated by visually impaired people reading the numbers. Arabic numerals are mandated because, contrary to popular perception, few visually impaired people read braille.

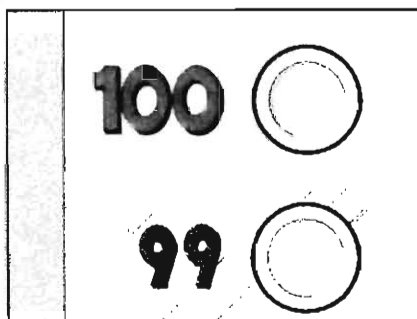

Button Design

Floor identification numbers next to buttons should be characters raised a minimum of 1/32 of an inch or .03 inches. According to the Massachusetts Commission for the Blind, a character height of 5/8 of an inch is better for touch-reading than the code requirement of 1/2 inch.

Because many people rely on elevators exclusively, elevators should be connected to emergency generators. It is very frustrating and potentially dangerous for a person to be trapped in a subway station during a power failure.

## Emergency System

Elevators should be equipped with an alarm system which rings Central Control and the fare collector when the elevator breaks down. Central Control can then keep the "Elevator Update Line" current. Many riders who rely upon elevators call the line before embarking on an MBTA ride. Central Control can also arrange for a speedy repair.

Two-way voice communication should be provided between the elevator and the fare collector's booth via perforated plate.

## Elevator Doors

Elevator doors must provide at least a 36 inch clear opening.

## Door Reopening Device

Specify a sensing mechanism for reopening the door that does not touch the person in the doorway. To detect people using wheelchairs, guide dogs, and canes, be sure that sensing devices are located at 5 inches and 29 inches above the floor. Elevator doors also should remain open long enough for people who move slowly to enter the doorway without being struck by the closing doors. The minimum time for the door to remain fully open is three seconds, if a non-contact sensing mechanism is used. Doors should close no faster than 1 foot per second.

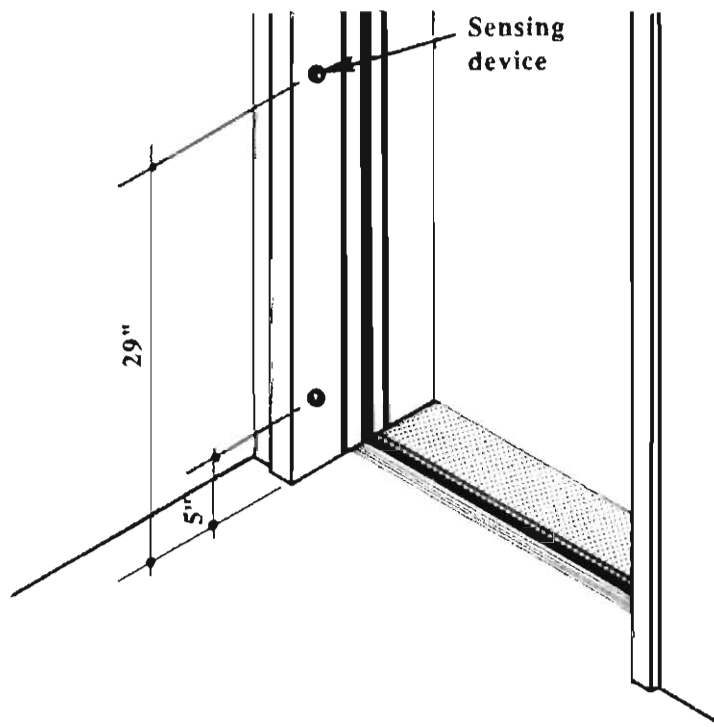

**Elevator Door Opening Device**

*MAAB 35.3 Elevator doors in constructed or reconstructed buildings shall provide a clear opening of at least 36 inches in width.*

*MAAB 35.3.1 Doors shall be power-operated and automatic, closing at a maximum speed of approximately one foot per second.*

*UFAS 4.10.6 Door Protective and Reopening Device. Elevator door shall open and close automatically. They shall be provided with a reopening device that will stop and reopen a car door and hoistway door automatically if the door becomes obstructed by an object or person. The device shall be capable of completing these operations without requiring contact for an obstruction passing through the opening at heights of 5 inches and 29 inches. Door reopening devices shall remain effective for at least 20 seconds...*

*MAAB 34.3.2 A door reopening device shall be provided to stop and reopen the car door and adjacent hoistway door when the car door is obstructed while closing. A non-contact sensing/reopening device may be substituted for a door safety edge if its effective area extends to the full door height. A localized non-contact device such as an electric eye may be used in addition to a full door height contact reopening device, provided that the localized device operated at 5 inches and 29 inches above the floor. Such non contact sensing devices are not required if a timer is set to hold the doors open a minimum of 6 seconds at each stop. If a non-contact sensing device is provided the minimum time for the door to remain fully open is 3 seconds.*

**Self-Leveling Mechanisms**

People using wheelchairs have difficulty entering or leaving elevators if the floor of the elevator is not level with the lobby floor, and people using walkers or canes are likely to trip. In existing elevators, faulty self-leveling mechanisms that are 1/2 inch or more out of line should be replaced.

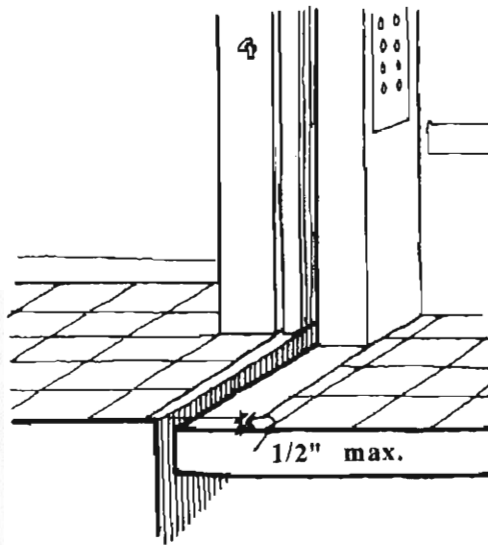
**Cab Leveling****Elevator Call Panel**

Mount the call panels in elevator lobbies where they can be reached from a wheelchair. MAAB requires the centerline of the highest button to be no higher than 42 inches above the floor. The space below the controls must remain free from obstructions, such as ashtrays or planters.

The UP and DOWN directional signals in elevator lobbies and in cabs should be unmistakable. Avoid relying exclusively on color to indicate up or down—a great many people cannot differentiate colors. The signal that works best is two directional arrows. Place the up button above the down button so that visually impaired people have an additional clue.

*MAAB 35.2 Operation: All elevators which are provided for public use shall be automatic, and shall be self-leveling with a maximum tolerance of plus or minus 1/2 inch under normal loading conditions.*

*MAAB 35.7 Hall buttons shall be located not higher than 42 inches from the centerline of the highest button, 10 floor. Button numbers, letters or symbols shall be 3/4 of an inch in height. No ashtrays or other obstacles shall be placed directly below or above the call buttons.*

Call buttons mounted low enough to reach from a wheelchair

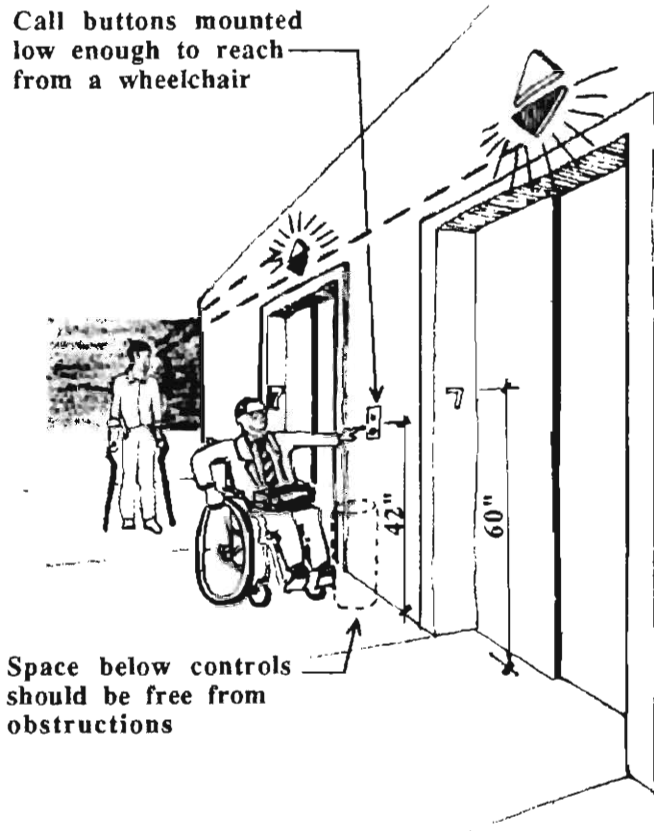

Space below controls should be free from obstructions

**Elevator Call Panel**

**Door-Jamb Floor Designation**

Let people know which floor they are on by installing raised numerals at least 2-1/4 inch tall on the outside jamb of the elevator door. Mount the jamb numerals consistently 60 inches above the floor so they can be easily seen by anybody in the elevator cab, and easily located by visually impaired people.

*MAAB 35.9 Door jamb markings indicating floor designations shall be provided at each hoistway entrance on both sides of jamb visible from within the car and the elevator lobby at a height of 60 inches above the floor. Numbers shall be on a contrasting color background a minimum of 2-1/2 inches high and raised three-hundredths (.03) of an inch.*

**Audible  
Direction  
Signaling**

*MAAB 35.6 A car position indicator shall be located above the control panel or door, and shall be illuminated on a contrasting background. In addition, audible signals shall indicate passing floors.*

*MAAB 35.8 Audible signals shall differentiate direction of travel as standardized nationally; one sound signal for up, two signals for down. An in-car signal lantern is permitted.*

Direction signals inside the cab should indicate audibly the floors passed or arrived at to help people with vision problems locate the floor they want. Visual floor indicators inside the elevator cab give hearing impaired people the same information in a visual form.

As the elevator doors open, visually impaired people need audible signals to indicate the elevator's direction of travel. One sound signals up and two sounds signal down.

---

SITE

---

ENTRANCE

---

FARE COLLECTION

---

VERTICAL CIRCULATION

---

**HORIZONTAL CIRCULATION**

**Schematic Horizontal Circulation** ■

**Accessible Route** ■

**Doors and Doorways** ■

**Floor Surfaces** ■

---

PLATFORM

---

INTERIOR STATION ELEMENTS

---

TOILET ROOMS

---

## Schematic Horizontal Circulation

Many people are aware of the need for accessible vertical elements such as ramps and elevators. But in fact, horizontal circulation is equally critical and needs equally careful thought.

Travel distances should be minimized to the extent possible. For people who have mobility limitations, the length of the trip determines the success or failure of it. Particular consideration should be made at transfer stations.

**Length of the  
Route of  
Travel**

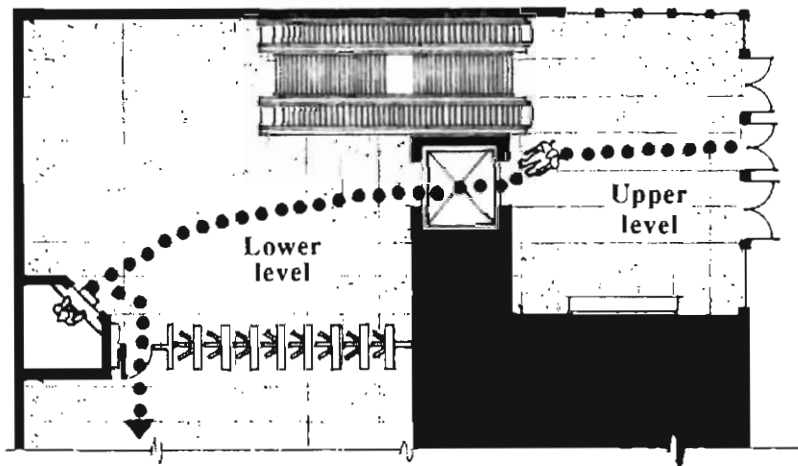

**Minimize Travel Distances Between Elements**

A simple path of travel will help people find their way. Visually impaired and developmentally disabled people have difficulty learning how to get around a station if it does not have an easily comprehended circulation pattern. A good example would be a linear or T-shaped path of travel which is easy for visually impaired people to memorize. Changes of direction, particularly within tunnels, are disorienting for riders.

**Circulation  
Pattern**

The schematic design should provide:

- minimum distances between station elements
- an accessible route of travel through the station
- a simple circulation pattern or a commitment to thorough signage directing people along the accessible route

**Schematic  
Design  
Summary:  
Horizontal  
Circulation**

## Accessible Route

Except where accessible vertical circulation is provided, an accessible route free from steps and stairs should link the accessible entrance(s) to fare collection and the platform. Particularly at transfer stations, check to see that connections between the four platforms can be made along an accessible route free from steps and stairs.

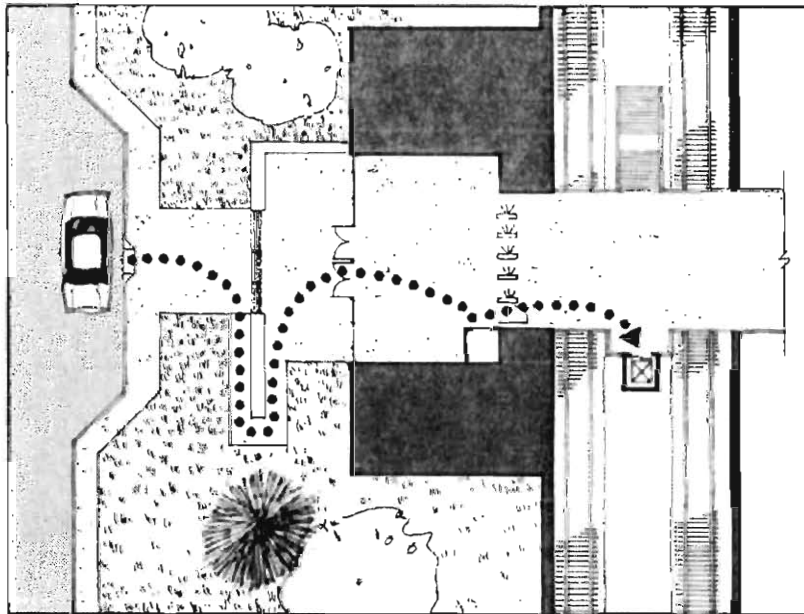

Horizontal Route Connections

- Slope** Any slope greater than 1:20 must be treated as a ramp.
- Width** All circulation spaces should be at least 36 inches wide with additional space for benches or other protruding objects. Telephones and drinking fountains must not effectively reduce the corridors' width or form obstacles in the circulation path. Place these protruding elements outside of the circulation path, in alcoves or cul-de-sacs, so that the corridor is safe for people with sight impairments and wide enough for mobility impaired people.
- Change of Direction** Width is especially critical when a corridor changes direction or approaches a doorway. It is important to have enough space to negotiate a 90 degree turn in a wheelchair. A 5 foot wide corridor assures this maneuverability.

*MAAB 5.12 Means of Egress: A continuous and unobstructed path of travel from any point in a building or facility to a public space. A means of egress comprises the vertical and horizontal means of travel and shall include sidewalks, walkways, sidewalk ramps, intervening room spaces, doors, hallways, corridors, passageways, balconies, ramps, stairs, enclosures, lobbies, escalators, horizontal exits, courts and yards. Such means of egress shall be in no instance less than 36 inches wide, except as provided in these Regulations.*

*UFAS 4.3.8 Changes in levels along an accessible route shall comply with 4.5.2. If an accessible route has changes in level greater than 1/2 inch then a curb ramp, ramp, elevator, or platform lift shall be provided that complies with 4.7, 4.8, 4.10, or 4.11, respectively. Stairs shall not be part of an accessible route.*

*UFAS 4.3.7 An accessible route with a running slope greater than 1:20 is a ramp and shall comply with 4.8. Nowhere shall the cross slope of an accessible route exceed 1:50.*

*UFAS 4.3.3 The minimum clear width of an accessible route shall be 36 inches.*

*UFAS 4.2.3 The space required for a wheelchair to make a 180 degree turn is a clear space of 60 inches diameter or a T-shaped space.*



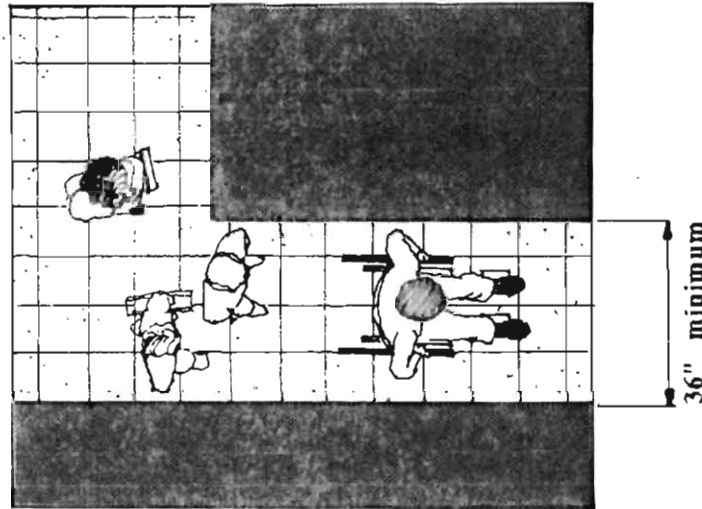

**Circulation Spaces Should Be at Least 36 Inches Wide**

It is essential to clearly mark the accessible route for mobility impaired riders. Signs displaying an arrow and the International Symbol of Accessibility should direct people along the accessible route. They should be in place at the same locations as all other directional signage and at every point a direction decision must be made. A designated accessible route will be especially appreciated at MBTA transfer stations which tend to have confusing routes of travel.

**Accessible  
Route  
Signage**

If the accessible route is complex—if, for example, it involves more than one elevator, or if more than two direction decisions must be made—consider using a painted line on the floor to designate the accessible route. The line should be supplemented with signs denoting the destination of the line, such as “Blue Line Outbound” or “Exit to Street.” This solution may be particularly useful at transfer stations.

One additional advantage is that some visually impaired riders will be able to see the contrasting line on the floor. There are people who use the MBTA who are both visually and mobility impaired. (See “Signage,” page 115.)

*MAAB 18.3.3 Within the terminal there shall be seating at intervals not to exceed 250 feet.*

Some people can walk only a short distance before they have to rest. Seating, therefore, must be provided at least within every 250 feet.

**Seating**

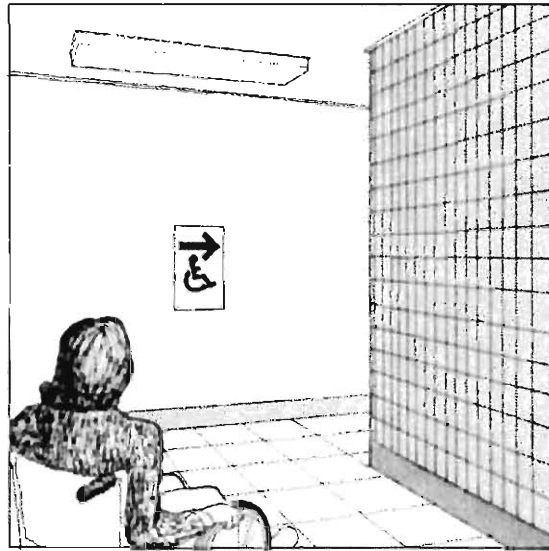

**Accessible Route Marked With Symbol of Accessibility**

### **Emergency Egress**

Emergency egress from above or below grade station levels is a challenge for mobility-impaired individuals who depend on elevators and escalators. Whenever possible, create accessible egress routes which can be used in an emergency. This can often be achieved on sloping sites where several floors can exit directly to the exterior grade.

In some stations, it may not be feasible to comply with the provisions of UFAS, which require places of refuge if accessible routes of egress are not available. In the area of accessible egress, as with many other areas of barrier-free design, access codes were developed with simpler structures in mind. The MBTA, after extensive consideration and consultation with the General Services Administration, has produced what it regards as a reasonable interpretation of the UFAS standard which can apply to emergency egress in transit facilities.

The MBTA is requiring station designers to provide at least two "Passenger Assistance Areas" at each platform. One of these should be located near main exit stairways, and another should be located at some distance away to account for the need for egress in another direction. These areas should be located so as not to impede the egress of other passengers as well as to protect the safety of the passengers who are waiting. The areas should be designated by means of signs and distinctive architectural finish. Each should have a police call-back intercom which can be used to alert station or emergency personnel of the need to provide assistance.

*UFAS 4.3.10 Egress. Accessible routes serving any accessible space or element shall also serve as a means of egress for emergencies or connect to an accessible place of refuge. Such accessible routes and places of refuge shall comply with the requirements of the administrative authority having jurisdiction. Where fire code provisions require more than one means of egress from any space or room, then more than one accessible means of egress shall also be provided for handicapped people. Arrange egress so as to be readily accessible from all accessible rooms and spaces.*

## Doors and Doorways

An inaccessible door blocks people from the station. Proper clearances and maneuvering space are critical to people with mobility limitations. Hardware selection and the weight of the door determine whether or not people with arthritis, prostheses, or limited dexterity are able to operate doors.

*MAAB 27.2 Doors to all public areas shall have a minimum width of 36 inches. Pivoted and balanced hardware doors and other non-hinged doors shall provide a minimum clear opening of not less than 34 inches measured at 90 degrees.*

People using wheelchairs or walkers need doors wide enough to pass through without bumping into the jambs.

### Doorway Size

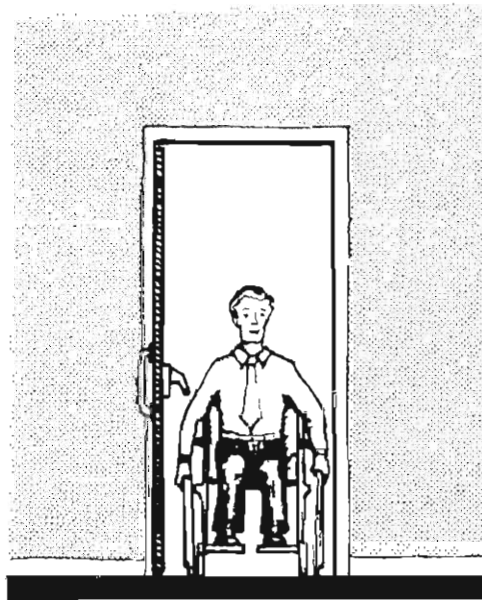

**Adequate Doorway Clearance**

There are two measurements that are used to describe an accessible doorway: **width** and **clear opening**.

The **width** of a door is the actual width of the door leaf. All doors along accessible routes must be at least 36 inches wide.

The **clear opening** is the effective width of the doorway when the door is open. The clear opening of a doorway is measured from the face of the stop on the latch side jamb, to the face of door when the door is open 90 degrees. This opening must be large enough for a person to maneuver a wheelchair through without scraping his or her hands. Some doors, particularly pivoted doors, may have to be specified wider than 36 inches to achieve the 34 inches clear opening.

**Double Doors** For double doors, at least one leaf of the pair must meet the 34 inch clear opening requirement.

*MAAB 27.3 At least one door of a pair of doors shall have a minimum width of 36 inches, or shall provide a minimum clear opening of not less than 34 inches, measured at 90 degrees.*

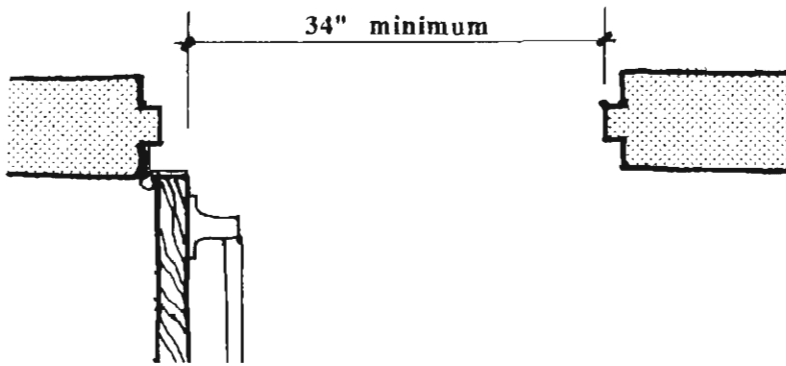

**Clear Opening**

## Existing Doorways

In existing buildings, many doors fall short of the door width requirement of 36 inches. There are several ways to make these doorways accessible. If the clear opening of an existing doorway is too small by an inch or two, accessibility may be achieved by changing the hinges to an offset hinge.

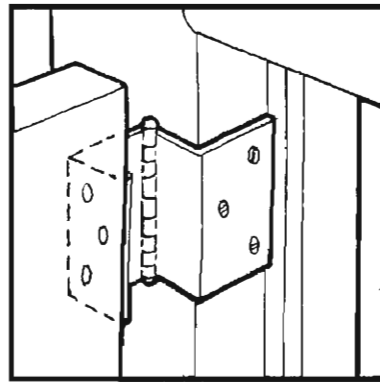

**Offset Hinge**

If the opening is more than 2 inches too narrow, the frame can be removed, a larger opening cut in the wall, and a new door and frame installed.

Double doors can be made accessible when neither leaf provides the 34 inch clear opening by installing a wide leaf and a narrow leaf in the existing frame.

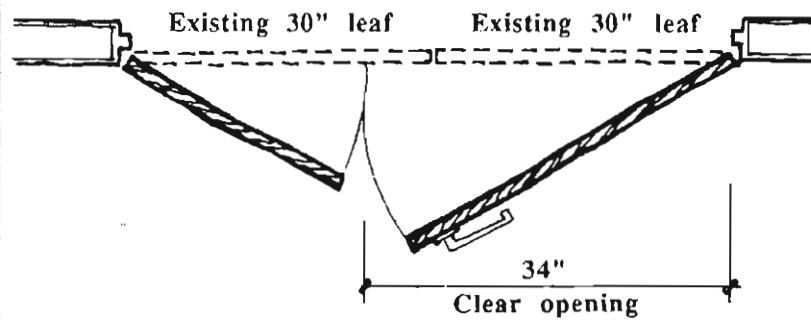

**Wide Leaf and Narrow Leaf in an Existing Double Door Frame**

**Maneuvering Space at the Door**

People using wheelchairs or crutches need to be able to move to the side of the door to pull it past themselves. Provide a clear area at least 18 inches, preferably 24 inches, on the pull side of the door latch.

It is also hard to open a door if your wheelchair is rolling away from it. Provide a level area on both sides of the door. On the push side of the door, there must be a level space at least 36 inches wide by 60 inches deep. On the pull side, the level area must be at least 54 inches wide by 60 inches deep.

*MAAB 27.4 There shall be a level clear floor area provided, beyond the latch, pull side of the door, doorway or gate, a minimum of 18 inches and preferably 24 inches.*

*MAAB 27.8 The floor inside and outside of each doorway shall be level for a distance of 60 inches from the door.*

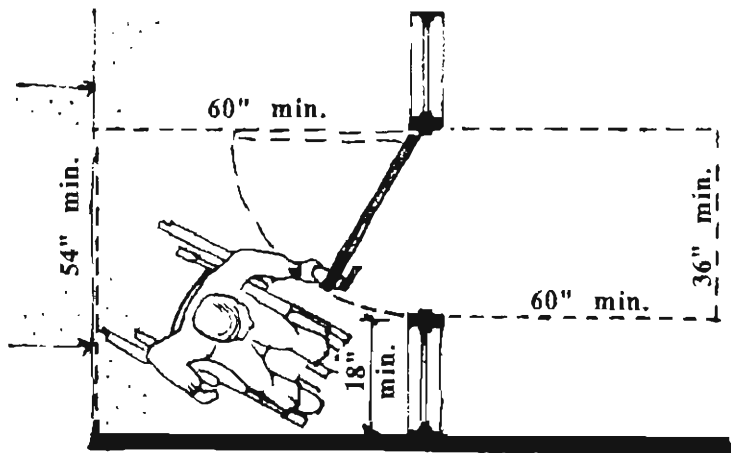

Maneuvering Space at the Door

## Existing Doors

One of the most frequent problems at existing buildings is the absence of maneuvering space beside the door on the latch pull side. Sometimes this can be solved by reversing the door swing. Other options include installing a mechanism for keeping the door open, such as a magnetic hold-open device, installing an automatic door opener, or removing the door entirely.

## Door Pressure

Many people cannot open doors that require more than 10-15 pounds of force. Design interior doors to open with no more than 5 pounds of applied pressure, and exterior doors with no more than 15 pounds of pressure. In some cases, doors cannot be kept closed at such low pressures. When this occurs, provide a compensating device which can be activated to reduce pressure, or a power door opener.

Doors that snap shut too quickly are also hazardous. Door closers, when provided, must allow at least 6 seconds before closing. Specify door closers that have pressure adjustments and delayed action closing.

*MAAB 27.6 Maximum pressure applied to the latch area to open exterior doors shall not exceed 15 pounds.... Doors requiring greater force shall be equipped with compensating devices to reduce the operating force, or shall be equipped with automatic opening devices.*

*UFAS 4.13.11 The maximum force for pushing or pulling open a door shall be as follows:  
...interior hinged doors: 5 lbf.*

*MAAB 27.5 Doors shall have a closing speed of not less than 6 seconds.*

Thresholds

MAAB 27.7 Exterior thresholds shall not exceed 1/2 inch in height, beveled on both sides. Interior thresholds shall be flush with the floor. Changes in floor finish materials may require an edge strip or threshold flush with the higher material and beveled at a ratio of one-in-four (1:4).

Thresholds are particularly difficult for people in wheelchairs or walkers and people with leg braces who cannot bend their knees or ankles. Exterior thresholds can be no higher than 1/2 inch and should be beveled on both sides with a ratio of 1:4. Thresholds at interior doors are undesirable from an accessibility standpoint.

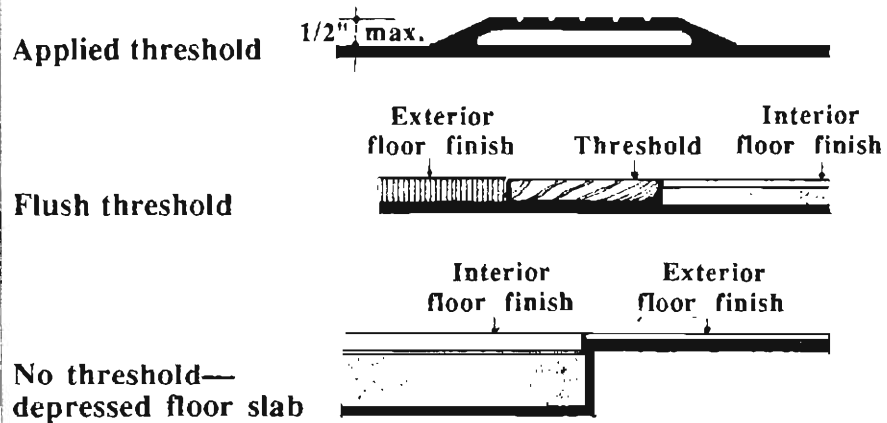

Exterior Thresholds

MAAB 27.9 Height: Hand-operated door-opening hardware shall be located 36 inches to 42 inches above the floor. When hardware is provided or changed on doors in the means of egress, levers, push plates, pull bars, panic hardware, etc., but not conventionally operating door knobs or thumb latch pull devices shall be used. All door hardware shall be operable with a closed fist.

People with arthritis, broken arms, or prostheses often have limited dexterity and need door handles that are operable without tight grasping or twisting of the wrist. Lever handles, loop handles, and push plates are easy to use. Knobs and thumb latches are impossible for some people to operate. Designers can check hardware themselves with the “closed fist test.” Simply, if hardware can be operated by a closed fist, it is acceptable.

Door Hardware

MAAB 27.11 Doors in the means of egress shall be operable with one hand and with a single effort. Doors in the paths of ingress shall be able to be unlocked and opened with one hand.

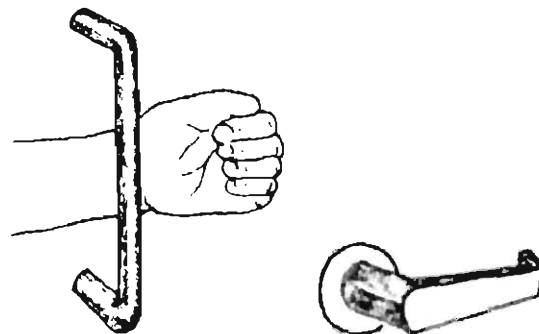

Accessible Door Hardware

The code requires accessible hardware on all doors in a path of egress, which includes most doors in a building.

Door hardware on doors leading to hazardous places should have a roughened or knurled surface to warn people with sight impairments. Hazardous areas are those with an unprotected change in elevation such as loading platforms, and those containing dangerous equipment such as electrical equipment rooms.

*MAAB 27.12 Doors opening into hazardous areas shall have door-opening hardware which is knurled or has a roughened surface to give tactile warning to the visually handicapped. Hazardous areas shall include loading platforms, boiler rooms, electrical equipment rooms, etc.*

### Kick Plates

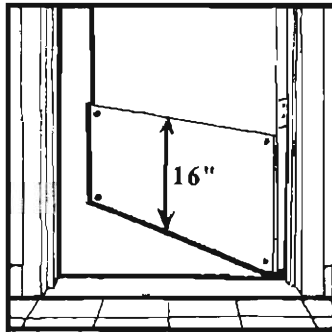

Kick Plate

To minimize the wear that doors receive from wheelchair footrests, install kick plates on the push side of doors that have door closers, such as entry and exit doors, toilet room doors, and corridor doors.



## Floor Surfaces

*MAAB 29.1 The floor on any single story shall be of a common level throughout, except where a ramp (as described in Section 25) connects different levels.*

*UFAS 4.5.4 Gratings. If gratings are located in walking surfaces, then they shall have spaces no greater than 1/2 inch wide in one direction. If gratings have elongated openings, then they shall be placed so that the long dimension is perpendicular to the dominant direction of travel.*

Interior floor surfaces affect how safely and comfortably people circulate in a building. In general, provide interior floor surfaces that are smooth, firm, stable, and non-slip.

Doormats that are permanently installed in entry vestibules can be a real impediment to wheelchair users unless they are recessed into the floor to eliminate the bump at the edge. If matting is used, it needs to be dense and firm enough so that a wheelchair can roll over it. If metal gratings are used, the gaps in the grating must run perpendicular to the direction of travel, and measure less than 1/2 inch so that wheels, heels and canes do not get caught in them.

Unit materials, such as brick and concrete pavers, often have joint irregularities that may exceed a quarter of an inch in height. This unevenness of surface is dangerous to a wide variety of users: people who are elderly, have lower limb amputations or arthritis, and people with fixed ankle braces, poor balance, or incoordination. People using wheelchairs often find the excessive bumping that comes from travelling on jointed materials to be extremely uncomfortable.

### Brick and Concrete Pavers

Since very minor changes in surface are sufficient to turn an ankle or cause a fall, brick and other unit flooring should be used only if it can be installed to very close tolerances. All ridges or bumps greater than 1/4 inches must be ground down after the material is laid.

### Changes in Flooring Materials

*UFAS 4.3.8 Changes in levels along an accessible route shall comply with 4.5.2. If an accessible route has changes in level greater than 1/2 inch, then a curb ramp, ramp, elevator, or platform lift shall be provided that complies with 4.7, 4.8, 4.10, or 4.11, respectively. Stairs shall not be part of an accessible route.*

Even slight level changes can be a barrier to a person using a wheelchair. Where floor finish materials change, an edge strip may be used, if it is flush with the higher material, and beveled at a ratio of 1:2 or less. Any level change over 1/2 inch must be treated as a ramp.

*MAAB 27.7 ...Changes in floor finish materials may require an edge strip or threshold flush with the higher material and beveled at a ratio of one-in-four (1:4).*

### Non-Slip Flooring Materials

Non-slip is a difficult term to quantify without instrumentation. Materials such as unglazed tile and broom-finish concrete are generally accepted as non-slip surfaces. Improper maintenance and cleaning techniques, however, can make them quite hazardous. Materials such as polished marble are almost always slippery, especially when wet, and should be avoided whenever possible.

*MAAB 29.2 Floors in the means of egress shall have a surface that is non-slip and shall be maintained with a non-slip material.*

---

SITE

---

ENTRANCE

---

FARE COLLECTION

---

VERTICAL CIRCULATION

---

HORIZONTAL CIRCULATION

---

PLATFORM

Schematic Platform Design ■

Platform ■

---

INTERIOR STATION ELEMENTS

---

TOILET ROOMS

---

## Schematic Platform Design

On the platform, safety and the ability to traverse an unobstructed path are of particular concern to people with mobility or visual impairments. They may be blocked by obstacles such as trash cans or structural columns, or endangered by hazards such as the platform edge.

Platforms should be wide enough for a person in a wheelchair or a parent with child and stroller to await a train without causing an obstruction for other passengers. There should be at least 6 feet of clear platform width, measured from the platform edge to the wall. Where there are benches, columns or other elements which project from the wall, measure the clear platform width from the platform edge to the edge of the benches or other elements.

### Platform Width

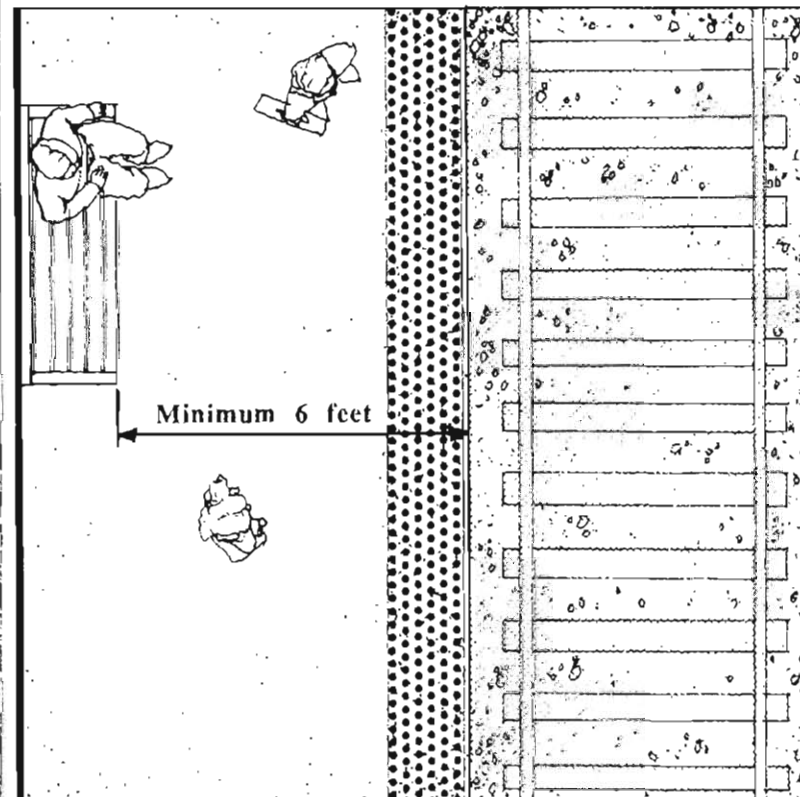

### 6 Feet of Clear Platform Width

All circulation space on the platform must be at least 36 inches wide. Consider this requirement when placing columns.

## Structural Elements

In the design of a new station, or in a structural renovation of an existing station, the placement of structural columns which intersect the platform should not effectively reduce the clear platform width. A person using a wheelchair needs at least a 36 inch wide path to be able to pass between a structural column and an adjacent wall or obstacle. More importantly, should a car door open in front of a structural column, a person using a wheelchair would need 60 inches between the platform edge and the column to disembark and turn to travel along the platform. In some existing stations, relocating the columns may be extremely impractical. An alternative would be to designate a train stopping point to ensure that doors will not open in front of columns.

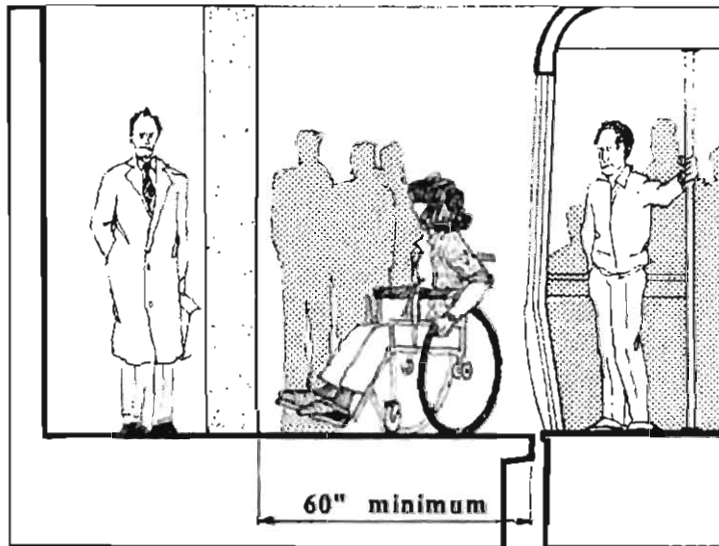

**60 Inches Between Platform Edge and Structural Column**

*UFAS 4.3.3 The minimum clear width of an accessible route shall be 36 inches.*

*UFAS 4.2.3 Wheelchair Turning Space. The space required for a wheelchair to make a 180-degree turn is a clear space of 60 inches diameter or a T-shaped space.*

## Schematic Design Summary: Platform

The platform design should provide:

- route(s) to and from the platforms which do not require the use of stairs
- at least 5 foot wide platforms, 6 foot preferred
- at least 60 inches clear space along the edge of the platform
- 36 inches between any two elements which the route of travel runs between
- maximum slope of 5%, parallel to the track

## Platform

*UFAS 4.5.1 Ground and floor surfaces along accessible routes and in accessible rooms and space, including floors, walks, ramps, stairs, and curb ramps, shall be stable, firm, slip-resistant, and shall comply with 4.5.*

*UFAS 4.3.7 Slope. An accessible route with a running slope of greater than 1:20 is a ramp and shall comply with 4.8...*

Platforms should be finished with non-slip materials such as broom finish concrete. Smooth terrazzo finishes are unacceptable indoors or outdoors because such surfaces can become slick when wet. Unit pavers may be used as long as they are set to close tolerances providing a level surface with no bumps or ridges. Durability of finish should be considered because a tile which initially has some "tooth" may become slippery with use.

Platform slope can pose a hazard to a person using a manual wheelchair who must prevent the wheelchair from accidentally rolling backwards or forwards. Slope in the direction parallel to the tracks should be as level as possible, not exceeding 1 foot of rise for every 20 feet of run, or 5%.

### Materials

### Slope

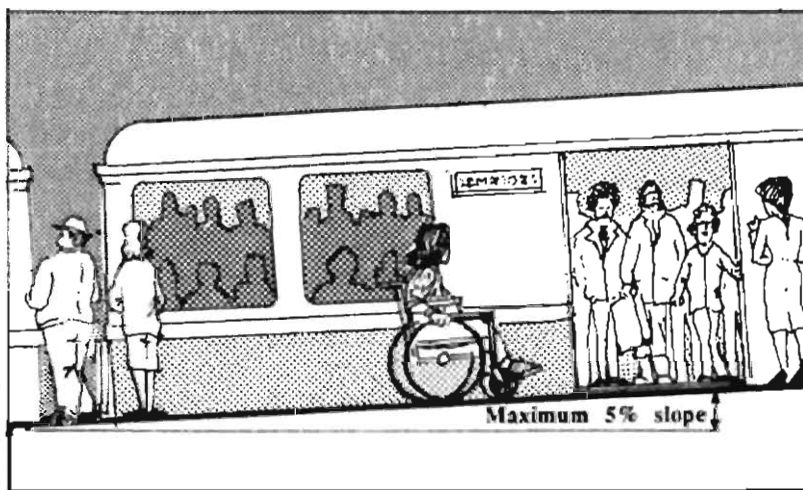

Platform Slope Should be Minimized

## Cross Slope

The cross slope (the slope perpendicular to the direction of the tracks) can be a maximum of 2%. If the platform slopes any steeper down to its edge, a person using a wheelchair must constantly prevent himself or herself from rolling down onto the tracks. If the platform slopes up to its edge, the manual wheelchair user must work hard against an uphill slope to board the car quickly. Therefore, cross slope should be as level as possible, not exceeding 1 foot of rise for every 50 feet of run, or 2%.

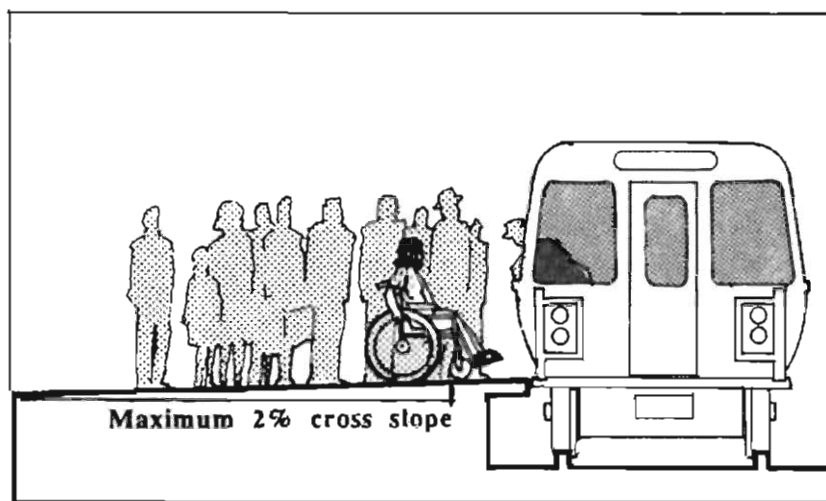

**Cross Slope of Platform Should Be Minimized**

## Platform Edge

To alert visually impaired riders of the edge, there must be a bright yellow tactile warning strip discernible underfoot at least 24 inches wide along the entire length of the platform edge. A visually impaired person walking towards the edge must be alerted by the warning material in time to stop. For this reason, the Massachusetts Commission for the Blind suggests a 24-36 inch minimum which allows a full pace between detection of the warning strip and the platform edge. The change in texture must be discernible underfoot through a shoe. This means the optimum material should have protrusions at least 3/16 of an inch high. The shape of the protrusion is significant—they should be domed rather than flat. The warning material can be made of plastic, pre-cast concrete, tile, or any other non-slip material which can provide protrusions. People with visual

*UFAS 4.3.7 Slope. ...Nowhere shall the cross slope of an accessible route exceed 1:50.*

*UFAS 4.5.1 Ground and floor surfaces along accessible routes and in accessible rooms and spaces, including floors, walks, ramps, stairs, and curb ramps, shall be stable, firm, slip-resistant, and shall comply with 4.5.*

*MAAB 18.6.4 The edge of all platforms at newly constructed, altered or remodeled stations shall have a yellow band of a different texture, distinguishable underfoot, and at least 24 inches in width, warning of a danger zone.*

impairments and their guide dogs are now being taught to recognize such material. The tactile warning material should be used *consistently* at the platform edge to provide a reliable signal. The material cannot be used for any other purpose, such as identifying pathways, if it is to maintain its effectiveness as a warning signal. The MBTA will provide an addendum to the *Guide to Access* with the results of its investigations into performance criteria for edge treatment. (See "*Maintaining Access*," page 177.)

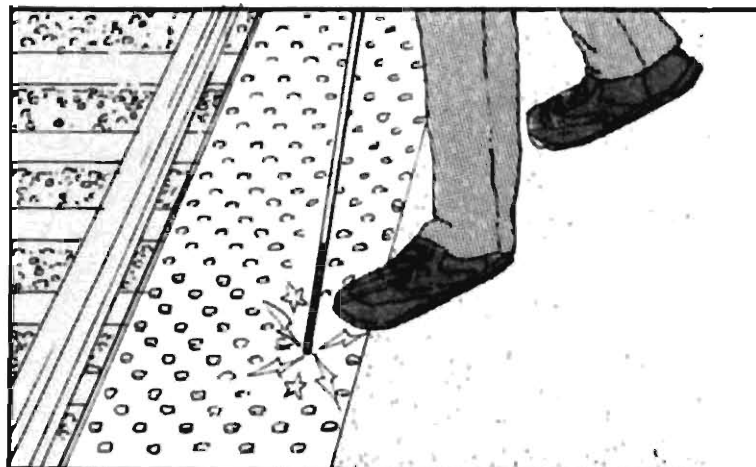

24 Inch Minimum Tactile Warning

Poorly placed, protruding elements such as benches, fire extinguishers, telephones, and trash cans can pose hazards for visually impaired riders. Hazards can be eliminated if these elements are recessed or equipped with wing-walls which extend to within 27 inches off the ground. Objects higher than 27 inches cannot be detected by cane.

### Obstructions and Protruding Objects

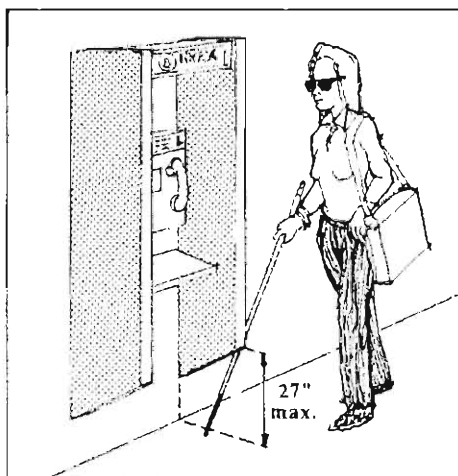

Protruding Object 27 Inches Off Ground



Objects such as trash cans should never be placed in front of a wall-mounted sign or map because some people need to stand very close to a sign to read it. Many visually impaired people can read signs if they stand within 2 inches of them.

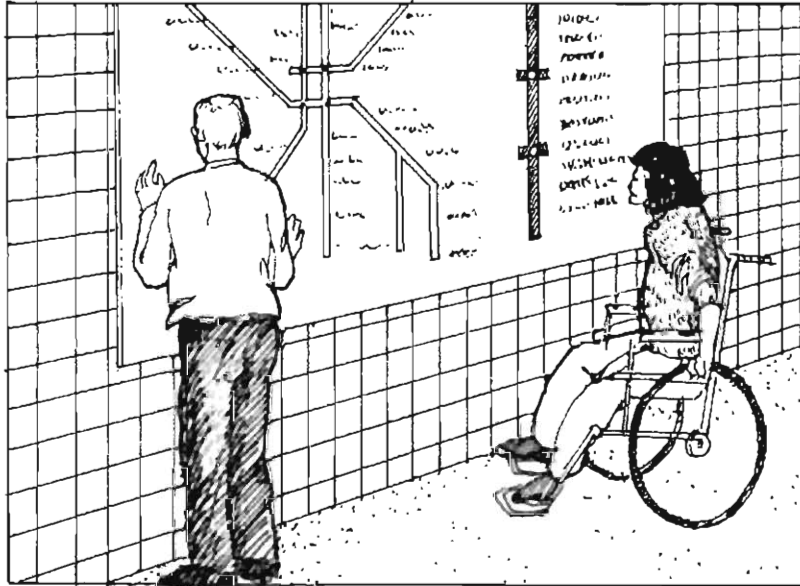

Clear Space in Front of Signage

*UFAS 4.4.1 Objects projecting from walls with their leading edges between 27 inches and 80 inches above the finished floor shall protrude no more than 4 inches into walks, halls, corridors, passageways or aisles. Objects mounted with their leading edges at or below 27 inches above the finished floor may protrude any amount.*

**Platform/Car Interface**

The gap between the platform and the car should be as small as possible considering operating tolerances, car design and other limiting factors. A pronounced horizontal and/or vertical gap between platforms and cars can be hazardous for all riders, especially for those who use wheelchairs because front caster wheels of wheelchairs can become trapped in the gap. Visually impaired users may trip or stumble on an unanticipated gap. The maximum allowable horizontal gap is 4 inches and the maximum vertical gap is 2 inches. Gaps should always be minimized.

*MAAB 18.3.1 The distance between platform and vehicle at boarding platforms shall not exceed 4 inches in the horizontal plane and 2 inches in the vertical plane.*

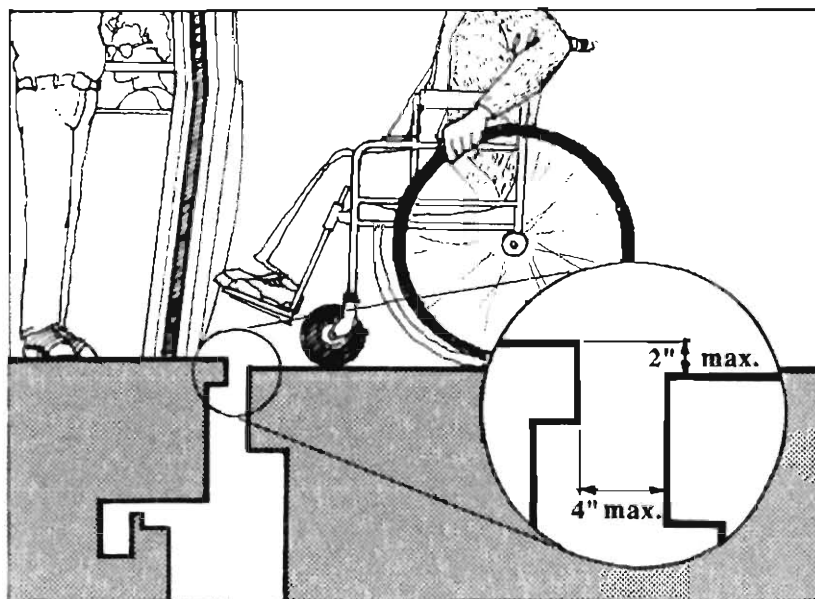

**Minimize Gap at Platform/Car Interface**

*MAAB 18.3.3 Within the terminal there shall be seating at intervals not to exceed 250 feet.*

Riders with or without mobility impairments welcome the opportunity to stop at a seat. Seating should be provided at intervals not to exceed 250 feet. Seats with arm rests at the ends will be easier for elderly people to rise from.

**Seating**

---

SITE

---

ENTRANCE

---

FARE COLLECTION

---

VERTICAL CIRCULATION

---

HORIZONTAL CIRCULATION

---

PLATFORM

---

INTERIOR STATION ELEMENTS

Signage ■

Public Address System ■

Drinking Fountains ■

Telephones and TDDs ■

Emergency Call Boxes ■

Emergency Alarms ■

Reader Boards and Video Monitors ■

Vendors ■

---

TOILET ROOMS

---

## Signage

Signs which are easy to read and are posted in consistent, accessible locations throughout the system benefit all MBTA riders. For a signage system to be accessible, visual and tactile means must be employed to provide routine information. Accessible features should be integral to all MBTA signage, not part of a parallel “special needs” sign system.

Signage can be designed to take advantage of the usable vision which many legally blind people retain. People who have partial sight loss need high contrast signage with large, easy-to-read lettering. Signs must be posted frequently throughout the station so that they can be spotted by people who have only a narrow cone of vision. Concise and succinct messages should be presented in graphic and verbal formats. Until the MBTA develops a new signage and graphics package, its current graphic standards should be consulted.

Contrast between letters and background is essential. White letters on colored bands are the preferred form of signage. Black lettering on white is acceptable as well. It is also helpful to have contrast between the sign and the wall on which it is mounted.

**Contrast**

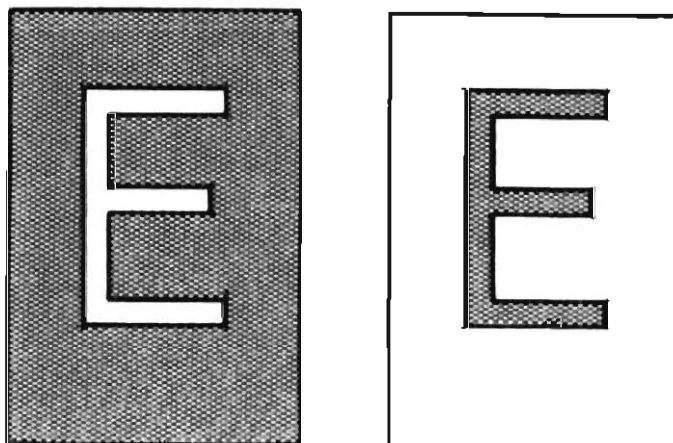

**Light Color Character on a Dark Background Is Preferred**

Particular care must be taken to select lighting which minimizes glare.

**Glare**

## Tactile Letters

Although not all visually impaired people can read braille, many can read raised print. Where tactile signs are incorporated, use capital letters set in sans-serif block type between 5/8 inch and 2 inches tall. Letters should be raised at least 1/32 inch.



Effective Profiles of Tactile Letters

Ineffective Profile

Because it is more difficult to read by touch than by sight, tactile maps should be as simple and straightforward as possible. Tactile maps, drawn approximately to scale, need to be larger than visual maps which present the same information. Tactile letters should be mounted no higher than 48 inches from the floor, where they will be in reach of a person seated in a wheelchair. When possible, use braille and tactile print on the same sign.

## Clear Space at Signs

Because many people need to be very close to a sign in order to read it, 48 inches clear space must be provided in front of any sign. This space allows visually impaired individuals to be within 2 inches of the sign. Riders with mobility impairments, particularly wheelchair users, need to be able to sit directly in front of or adjacent to signs placed at accessible heights.

Wherever possible, signage should be placed perpendicular to the direction of travel. Perpendicular placement makes signs easy to notice for all people and is particularly useful for people who have a loss of peripheral vision.

## Sign Placement

(See "Accessible Route Signage," page 93.)

## Wayfinding In the Station

Spider maps posted in the station and on subway cars must identify accessible stops. Because the status of the stations is constantly changing, a system of identifying current accessibility must be available.

## Spider Maps

*MAAB 40.1 The International Symbol of Accessibility shall be displayed in the following locations:*

*MAAB 26.7 Identification: Any entrance of a facility not accessible by persons in wheelchairs shall have a sign clearly indicating the location of the accessible entrance.*

Accessible entrances should be identified with the International Symbol of Accessibility. All inaccessible entrances must have a sign with the International Symbol of Accessibility and an arrow indicating the accessible doorway and written direction if needed. This sign should be tactile and should, if possible, be placed between 45 and 60 inches above the finished floor or ground to the right of the doorway, so that a person in a wheelchair as well as a visually impaired person can find it.

## Entrance

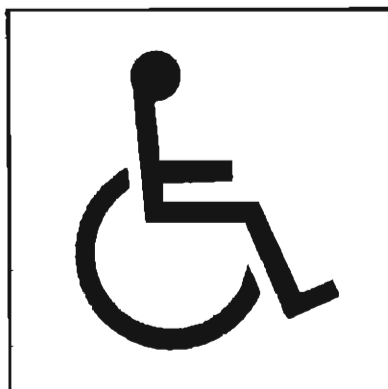

**International Symbol of Accessibility**

## Stairs/ Escalators

Tactile signage should indicate whether stairs or escalators lead to an inbound or an outbound platform. These signs should be placed 60 inches above the finished floor at the right-hand side of the stairwell.

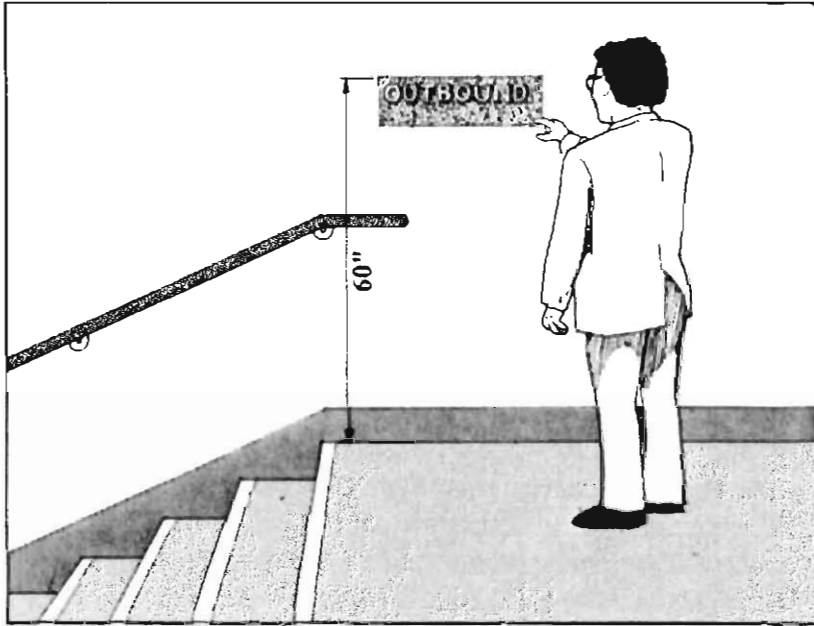

**Tactile Signage Indicating Inbound or Outbound Platform**

## Toilet Rooms

MAAB requires inaccessible public toilet rooms to be identified with the International Symbol of Accessibility, accompanied by an arrow directing people to the accessible toilet room.

While it is mandated only for public toilet rooms, it is also recommended that *any* toilet room—public or employee—be so identified because a person in a wheelchair, not knowing that the toilet room is inaccessible, can become trapped if the vestibule is improperly arranged or if there is no room to turn around.

*MAAB 40.1.2 At the entrance to all public toilet rooms, if one is not accessible, the symbol shall be placed at that toilet room indicating the location of the nearest accessible toilet room.*

Pictographs on platform signage help visually impaired people identify their location at a glance. This practice, already in place at some stations, is strongly encouraged.

**Platform  
Station ID**



### Public Address System

Clear public address announcements are critical to people with visual impairments who rely on them entirely. Particularly in an emergency situation, the P.A. announcements may be someone's only source of information. It is therefore recommended that a NOALA system (Noise Operated Automatic Level Adjustment) be provided in particularly noisy areas so that all messages will be intelligible and easily understood. The NOALA system adjusts the volume according the level of noise in the station.

Since a high level of ambient noise in the station is inevitable, audio messages should be clearly articulated and repeated. For hearing impaired riders, P.A. announcements should be simultaneously broadcast on a reader board whenever possible.

## Drinking Fountains

*MAAB 36.1 At each location where drinking fountains or coolers are provided, at least one fountain shall be accessible to persons in wheelchairs.*

Drinking fountains are provided only at terminus stations. For many people with disabilities, however, they are not a luxury but a necessity. Many people who use wheelchairs need to maintain a high daily fluid intake to counteract the impact that spinal cord injury or immobility has on their kidneys.

Wherever drinking fountains exist, be sure that there is at least one accessible drinking fountain.

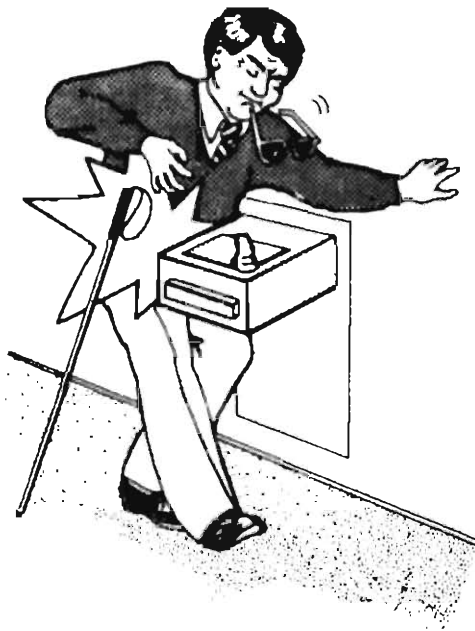

### Hazard to Visually Impaired People

Be sure that drinking fountain locations do not pose a hazard to people with visual impairments. Where possible, locate drinking fountains in a recess or alcove. When drinking fountains must be located in a hallway, they must not project into the path of travel unless they are detectable by cane.

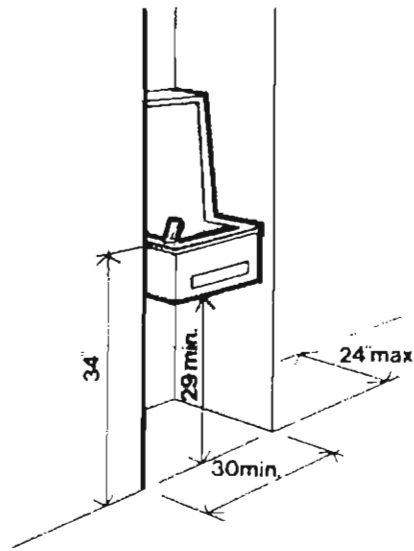

**Alcove Installation of Drinking Fountain**

## Wall-Mounted Drinking Fountains

The preferred type of drinking fountain is wall-mounted with a knee space beneath it. The open knee space under the drinking fountain needs to be at least 30 inches wide, 22 inches deep, and 27 inches from the floor to the underside of the drinking fountain. If the bottom of the projecting edge is no higher than 27 inches, it can be detected by cane users.

*MAAB 36.1.2 Basin rims of wall-mounted drinking fountains shall be mounted not more than 34 inches above the floor.*

*MAAB 36.2 Where accessible drinking fountains are located in a recess, the recess shall not be less than 30 inches wide, nor deeper than the depth of the drinking fountain.*

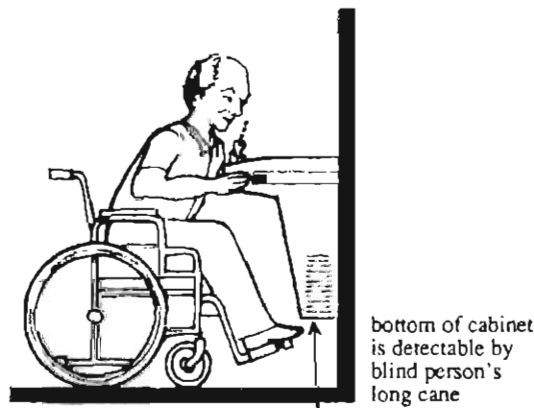

**Wall-Mounted Drinking Fountain**

Mount drinking fountains so that the rim of the basin is not more than 34 inches above the floor.

*MAAB 36.3 Freestanding or built-in accessible units not having clear space under them shall have a clear floor space at least 30 inches by 48 inches that allows a person in a wheelchair to make a parallel approach to the unit.*

In existing buildings where freestanding drinking fountains without knee space are already in place, be sure that there is a 30 inch by 48 inch clear floor space in front of the drinking fountain. This allows someone in a wheelchair to make a parallel approach.

**Freestanding Drinking Fountains**

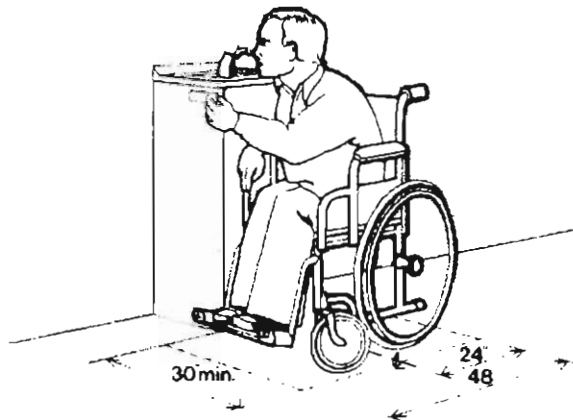

**Freestanding Drinking Fountain**

Some people with disabilities cannot use parallel-approach drinking fountains because of the twisting and reaching required. A good solution to this problem is a dual-level drinking fountain. Attach a wall-mounted drinking fountain, with its rim at 34 inches, beside the existing freestanding fountain.

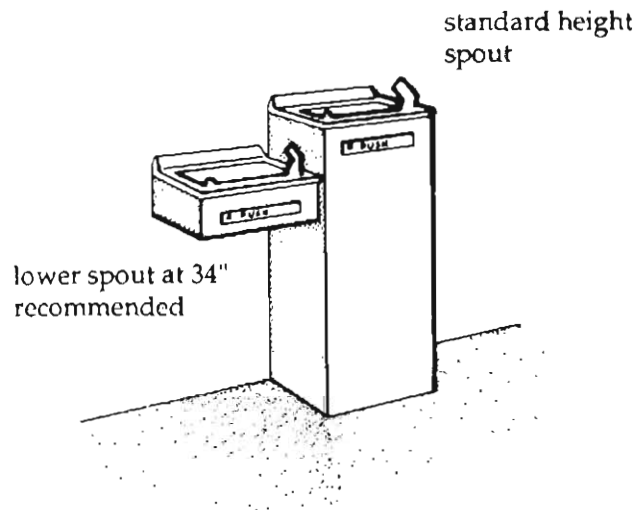

**Dual-Level Fountain**

# Drinking Fountains

## Controls

Test drinking fountain controls by using a fist and light pressure

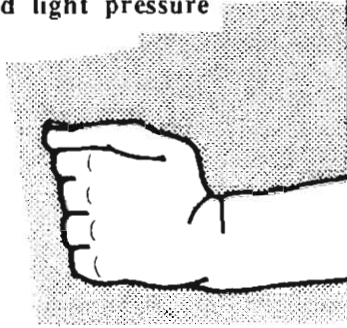

Fountain Control

To ensure that everyone can use a drinking fountain, provide a control that can be operated by a closed fist, using no more than 5 pounds of pressure. Since some people can operate a control using only one side of their body, it is best to have one control on each side of the fountain, or one in the front.

*UFAS 4.15.4 Controls. Controls shall comply with 4.27.4. Unit controls shall be front mounted or side mounted near the front edge.*

*UFAS 4.27.4 Operation. Controls and operating mechanisms shall be operable with one hand and shall not require tight grasping, pinching, or twisting of the wrist. The force required to activate controls shall be no*

Electronically activated valves and metered flow valves are acceptable only if they provide ample time for slow-moving people to drink.

*MAAB 36.1.1 Drinking fountains shall have hand-operated pushbutton or lever controls, and shall have spouts located near the front. Spouts shall direct a stream of water as parallel to the front of the fountain as possible. Knob type faucets are not permitted. Other types of controls may be installed in addition to, but not instead of, hand-operated controls.*

## Spout Design

Specify drinking fountains with spouts that direct the water flow at least 4 inches high and as close to parallel to the front of the drinking fountain as possible. This makes it easier for people in wheelchairs to reach the stream of water.

*UFAS 4.15.2 Spout Height. Spouts shall be no higher than 36 inches, measured from the floor or ground surfaces to the spout outlet...*

To use a cup, water flow must be at least 4" high

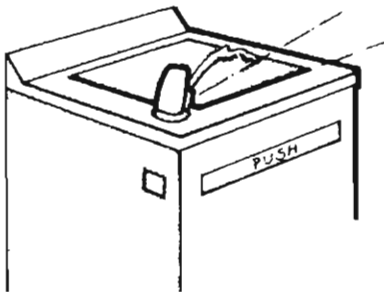

Water direction parallel or slightly angled

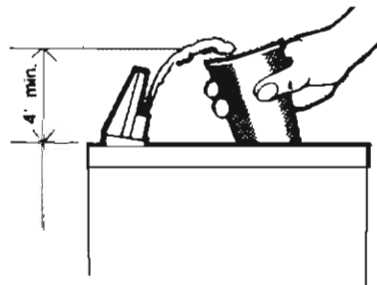

Spout Design

*UFAS 4.15.3 Spout Location. The spouts of drinking fountains and water coolers shall be at the front of the unit and shall direct the water flow in a trajectory that is parallel or nearly parallel to the front of the unit. The spout shall provide a flow of water at least 4 inches high so as to allow the insertion of a cup or glass under the flow of water.*

## Telephones and TDDs

*MAAB 37.1 Wherever public telephones are provided, at least one telephone shall be accessible to and usable by a person in a wheelchair.*

At least one telephone in each bank must be accessible to people with disabilities. For people with hearing impairments to have means of communicating with an MBTA staff person, the Office of Transportation Access recommends one TDD at each station. To control vandalism, a TDD which is built into a public telephone is available. The TDD drawer does not slide out of the telephone until a call is placed to another TDD and that party answers.

The TDD must be accessible from a wheelchair. The TDD should be mounted 34 inches above the floor where it can be used by both seated and standing persons.

Wall-mounted telephones need to have a knee space below them at least 12 inches deep, 30 inches high, and 30 inches wide. If wall-mounted telephones project more than 4 inches from the wall, locate them in an alcove to prevent them from being a hazard to visually impaired people.

**Wall-  
Mounted  
Telephones**

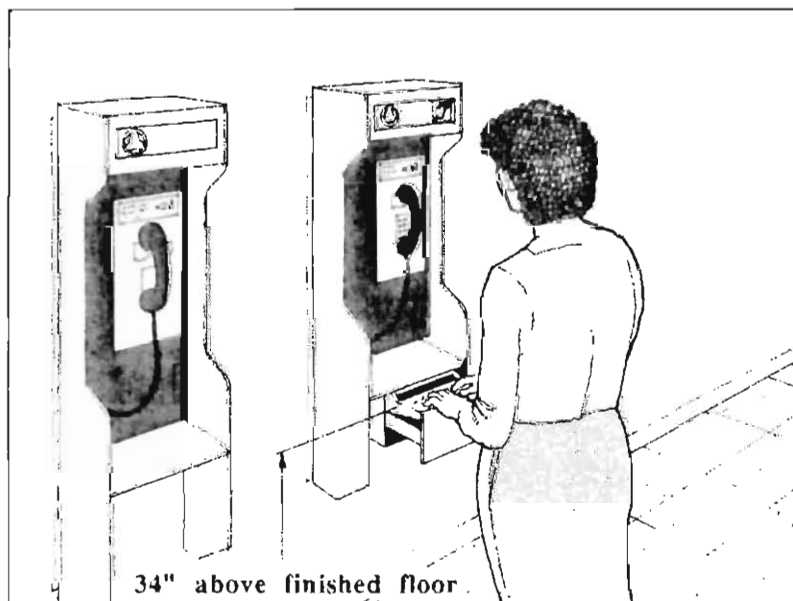

**Accessible TDD and Telephones**

## Telephones and TDDs

**Clear Space** Telephones need a space in front of them of at least 30 inches by 48 inches so that wheelchair users can use them from a parallel position.

**Mounting Height** Be sure that all operating parts of the phone—such as the coin slot, card slot, dial, and receiver—are no more than 54 inches above the floor.

**Features** Because some people cannot use their fingers to turn dials, push-button phones are required.

A person seated in a wheelchair may need a slightly longer cord. Cords from the phone to the handset must be at least 29 inches long.

The range of hearing impairments is great. A person with a slight hearing loss can often use a phone which is equipped with volume control or an inductive coil. The accessible phone must be equipped with both. Instructions for use of the volume control should be attached to the phone.

**Signage** The accessible telephone should be clearly identified with signage displaying the appropriate international communication access symbols. There are pictographs which specifically represent amplification and TDDs. The general communication access symbol (copyrighted by the National Association for the Deaf) usually signifies complete communication accessibility, or it can be used in conjunction with other symbols or written words to denote a specific type of access. The Massachusetts Commission for the Deaf and Hard of Hearing can provide information on the proper usage of these symbols.



**General  
Communication  
Access**

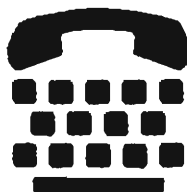

**TDD**



**Amplification**

*MAAB 37.4 Unobstructed access within 12 inches of the telephone shall be provided. Such access shall be a clear opening not less than 30 inches in width and height.*

*UFAS 4.31.2 Clear Floor or Ground Space. A clear floor or ground space at least 30 inches by 48 inches that allows either a forward or parallel approach by a person using a wheelchair shall be provided at telephones... Bases, enclosures, and fixed seats shall not impede approaches to telephones by people who use wheelchairs.*

*MAAB 37.2 The dial, handset and coin deposit slots, or the highest operating part, shall be mounted not more than 54 inches above the floor, assuming vertical access.*

*UFAS 4.31.6 Controls. Telephones shall have pushbutton controls where service for such equipment is available.*

*UFAS 4.31.8 Cord Length. The cord from the telephone to the handset shall be at least 29 inches long.*

*MAAB 37.5 The accessible telephone shall be equipped with an adjustable volume control for the headset, and instructions for use of the control shall be attached to or next to the telephone.*

*MAAB 37.3 The receiver shall be equipped with an inductive coil to provide a magnetic field for hearing aid telephone switches, and shall be identified as being so equipped.*

## Emergency Call Boxes

*MAAB 38.1 Where switches, locks and controls are provided for public use, they shall be placed no higher than 48 inches, or lower than 36 inches from the floor, with the exception of thermostats, intercoms, and fire alarms, which may be centered no higher than 54 inches, and electrical outlets which may be centered no lower than 18 inches from the floor.*

Emergency call boxes must be placed within reach of people seated in wheelchairs. The highest operable part of an emergency call box should be no more than 54 inches above the floor. Such controls must also be at least 18 inches away from the corner of the wall to ensure that a person in a wheelchair will be able to reach it.

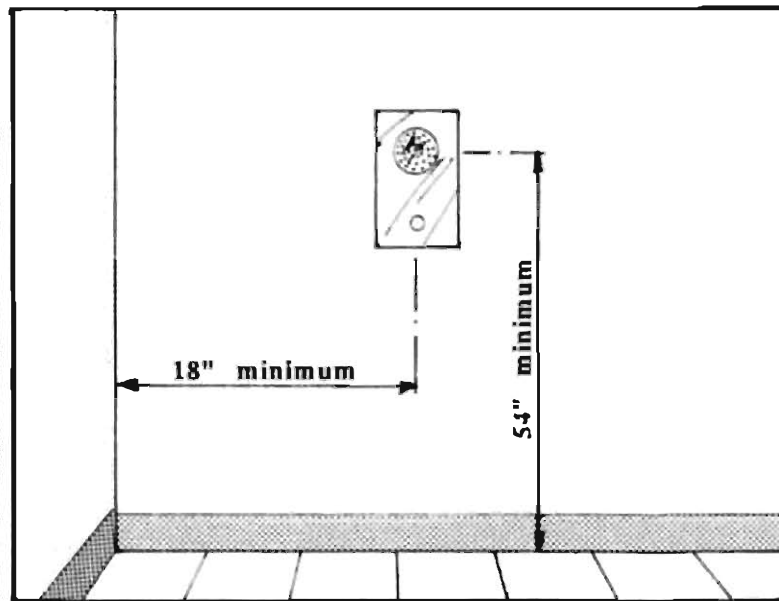

**Emergency Call Box**

*UFAS 4.27.3 Height. The highest operable part of all controls, dispensers, receptacles and other operable equipment shall be placed within at least one of the reach ranges specified in 4.2.5 and 4.2.6...*

*UFAS 4.27.4 Operation. Controls and operating mechanisms shall be operable with one hand and shall not require tight grasping, pinching, or twisting of the wrist. The force required to activate controls shall be no greater than 5 lbf.*

Alarm mechanisms should be operable by simple pushing. Designers can select appropriate controls by trying to operate them with a closed fist. Be sure controls can be activated with no more than 5 pounds of pressure.

Wherever an emergency call box is provided, means of communication with staff should also be provided to hearing impaired riders. TDDs are an acceptable method, but a simpler solution may be to provide an emergency button, connected to the police, and an adjacent button light which indicates that the message has been received and help is on the way. Such a button might also be easier for any patron in an emergency. Individuals with multiple auditory and mobility impairments would find this method easier as well. The button should be identified with a tactile sign and instructions.



## Emergency Alarms

Visually impaired people need emergency alarms they can hear, and hearing impaired people need alarms they can see or feel. Emergency alarms, therefore, must be both audible and visual. Audible and visual signals should operate simultaneously, such as lighted exit signs that flash and beep when the alarm system is activated. Consider DC hook-up for all hard-wired warning systems, in case of power failure.

### Audible Alarms

Specify audible alarms that will alert people who are hard of hearing. The Commission for the Deaf and Hard of Hearing makes the following recommendations:

- Alarms should have a frequency of 1,000 to 3,000 Hz.
- Alarms should pulsate at a rate of 4 per second, or less, as opposed to being steady state.

The alarm must also be sufficiently louder than the background noise to be heard as an alarm:

- Signal-to-noise (S/N) ratio of ambient room noise and the alarm signal should be a minimum of 10 dB.

Even in areas with little or variable background noise, the alarm must reach a “threshold” of loudness to be heard by a hard-of-hearing person. Technically, this means:

- The output should be of sufficient magnitude so that the audible signal reaches the individual at a minimum of 70 dB, regardless of background noise.

The maximum value for audible alarms is 120 dB. There is no need for an alarm to exceed this output.

### Visual Alarms

Visual alarms are effective only when they are within the vision range of hearing-impaired people. Flashing white lights are the most effective way to catch the attention of someone with a hearing impairment. Flashing frequency should not exceed 1 Hz. Specify EXIT signs with internal flashing illumination.

*MAAB 39.3 Where warning signals such as fire alarms are being installed in public areas, they shall be equipped with visual signals as well as audible signals. Visual signals shall flash no faster than 5 cycles per second.*

## Reader Boards and Video Monitors

In order to meet the specific needs of both hearing impaired and visually impaired riders, visual as well as audible displays are essential. Hearing impaired riders cannot hear public address announcements about delays, express trains, or emergencies, and may have difficulty asking questions and receiving directions from MBTA personnel. These riders need dynamic visual displays, such as reader boards and video monitors, to provide them with up-to-the-minute information.



**Reader Board**

On the platform, riders need to be kept informed of approaching trains, delays and emergency information. A reader board should be installed within easy sight of passengers on both platforms or the central platform, as the case may be. The reader board should not continuously scroll messages but should post clearly worded notices which remain on the screen. The letters should be large-type sans-serif letters.

Video monitors work best at eye level. If the monitor is raised to protect it from vandalism, the letters must be larger. The monitor could also be inside the fare collection booth pushed up against the window. Since video monitors are most effective at eye level, a reader board may be a better choice.

## Vendors

When the real estate management department of the MBTA establishes contracts with outside vendors such as newspaper stands and snack booths, the following conditions should be discussed:

Vending machines must not create an obstacle in the accessible route of travel. Circulation space at least 36 inches wide should be maintained around them. Also, they should not be placed where a visually impaired person is likely to crash into them. It is especially important that they not be placed in front of signs because many visually impaired people need to stand within two inches of a sign to read it.

Vendor counter heights and any item placed on the counter for sale should be made accessible to all MBTA patrons including persons using wheelchairs. Where counters are above 40 inches, an adjacent section of the counter should be provided at a height of 34 inches if possible. Services at this section should be equivalent to those provided at the higher section of the counter. It is particularly important for utensils, napkins, and any other self-service item to be placed at the shorter counter where they will be within reach of those who cannot reach the high counter, such as elderly people, children, and people seated in wheelchairs. The space in front of these counters should be kept clear.

---

SITE

---

ENTRANCE

---

FARE COLLECTION

---

VERTICAL CIRCULATION

---

HORIZONTAL CIRCULATION

---

PLATFORM

---

INTERIOR STATION ELEMENTS

---

**TOILET ROOMS**

**Public and Employee Toilet Rooms**

---



**Urinals**

A properly installed urinal can save wheelchair users a time-consuming transfer to a toilet seat. Wall-mounted urinals must project at least 14 inches from the wall. This allows a person in a wheelchair to get close to the rim.

There must be a clear floor space for a wheelchair 30 x 48 inches in front of the urinal. Behind the clear space at the urinal, provide an area 60 x 60 inch diameter or T-shaped space so that the wheelchair user can turn around.

If urinal shields are provided, they should not extend beyond the front edge of the urinal rim. There should be 29 inches clearance between them.

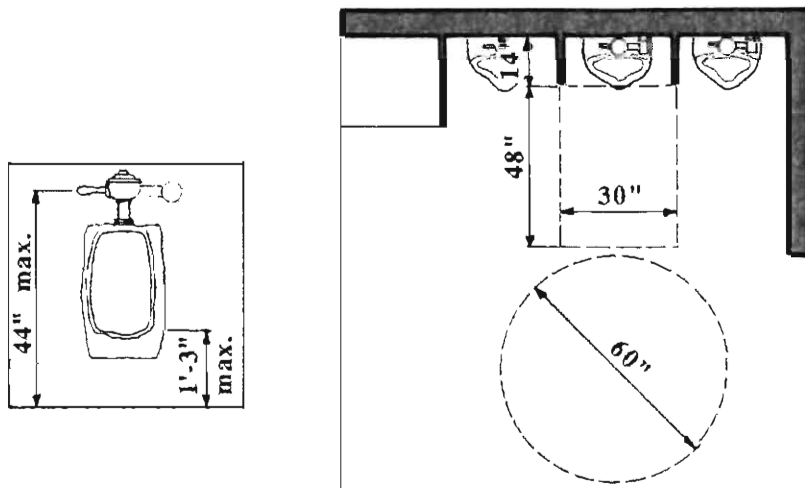

**Accessible Urinals**

**Urinal Height** The standard height of wall urinals at 24 inches presents problems for small boys and for men using wheelchairs. According to MAAB, an accessible urinal should be mounted no higher than 15 inches so that the rim is lower than the wheelchair seat. People who use wheelchairs may have to empty leg bags. This is much easier when urinals are mounted below 15 inches. UFAS requires the rim to be elongated.

*UFAS 4.18.3 Clear Floor Space. A clear floor space 30 in by 48 in shall be provided in front of urinals to allow forward approach. This clear space shall adjoin or overlap an accessible route and shall comply with 4.2.4. Urinal shields that do not extend beyond the front edge of the urinal rim may be provided with 29 in clearance between them.*

*MAAB 30.6 Where urinals are provided, one urinal shall be either wall-mounted with the rim of the 15 inches above the floor maximum, or floor-mounted.*

*UFAS 4.18.2 Urinals shall be stall-type or wall-hung with an elongated rim ...*

Some people can use a toilet only if it has a back against which they can lean for support. Tank-type fixtures meet this need. On flush-valve toilets install a standard seat lid with a bumper to hold it vertical against the flush valve. It must be able to remain in a vertical position when placed there.

Flush controls can be standard types, but must be easily operable with one hand. They should be mounted no more than 44 inches above the floor. Foot-operated flush valves are impossible to operate for most people in wheelchairs and should not be used.

If the toilet seat is too high, many people cannot transfer from a wheelchair onto the toilet. Yet if the toilet seat is lower than the wheelchair seat, many people can transfer onto but not off the toilet.

The code recommendation for toilet seat height, 17 to 19 inches, is fine for people who use manual chairs, but a little low for those who use motorized chairs. Therefore, using a seat height of 19 inches is recommended. The higher seat is also preferred by people who have trouble sitting down and standing up.

**Toilet Seat Height**

*UFAS 4.16.3 Height. The height of water closets shall be 17 inches to 19 inches, measured to the top of the toilet seat. Seats shall not be sprung to return to a lifted position.*

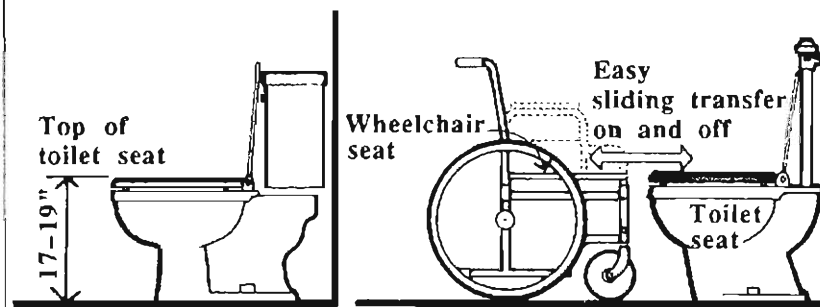

**Toilet Seat Height**

Many manufacturers give a dimension to the top of the toilet rim, not the top of the toilet seat. Be sure to check the manufacturer's specifications carefully before selecting a toilet.

## Paper Dispenser

Locate the toilet paper dispenser on the side wall closest to the toilet where it can be easily reached from the toilet seat. Mount it 36 inches from the back wall and 24 inches above the floor. Dispensers that control delivery or that do not permit continuous flow of paper are not allowed. Waste receptacles for sanitary napkins should also be located where they are reachable from the toilet.

*MAAB 30.9 Toilet paper dispensers shall be located on the side wall closest to the toilet, and be set at a height of 24 inches above the floor. Dispensers that control delivery, or that do not permit continuous paper flow are not allowed.*

*UFAS 4.16.6 Dispensers. Toilet paper dispensers shall be installed within reach, as shown in Fig. 29(b)...*

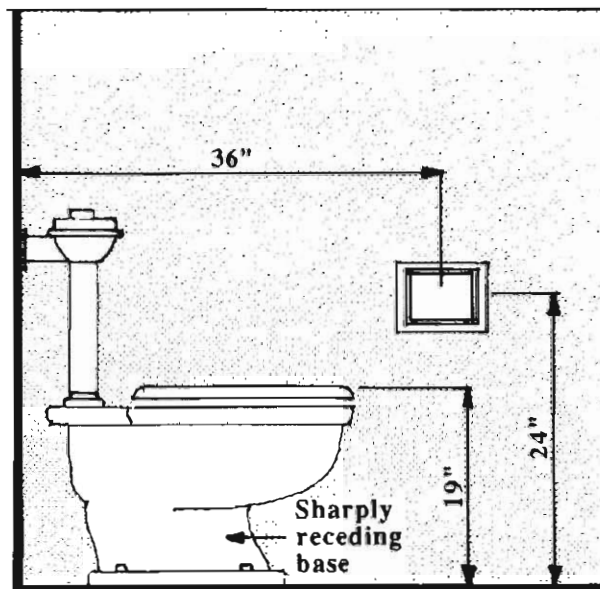

**Floor-Mounted Toilet With Receding Base**

## Toilet Type

The code allows tank type and flush-valve type toilets, either wall-hung or floor-mounted. Wall-hung models are preferred because they allow wheelchair foot rests extra maneuvering space under the fixture. Wall-hung toilets can also be mounted at the optimal height. If floor-mounted toilets are used they must have a sharply receding base, providing more maneuvering space for wheelchairs.

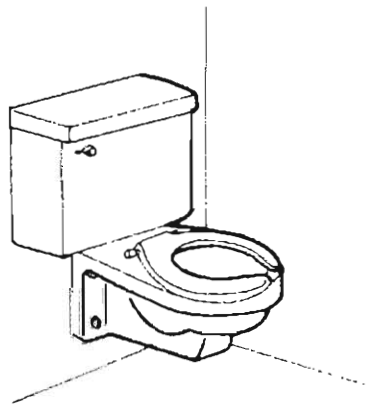

**Wall-Mounted Toilet**

MAAB 30.5.4...Grab bars shall be 1-1/4 inches in outside diameter, have a 1-1/2 inch clearance between the bar and the wall, and be ... acid-etched or roughened.

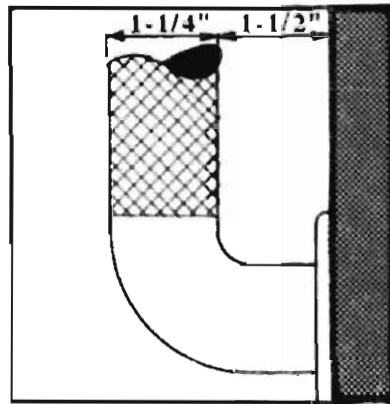

Grab Bar Design

An acid-etched or roughened grab bar surface assures a good grasp even if one's hands are wet. A 1-1/4 inch diameter is a good size for a firm hold. The grab bar should be mounted exactly 1-1/2 inches from the wall, so people can easily get their hands around it, but are not in danger of getting their elbow or arm caught should they fall.

## Grab Bar Design

UFAS 4.26.3 Structural Strength. The structural strength of grab bars, tub and shower seats, fasteners, and mounting devices shall meet the following specification: ... (3) Shear force induced in a fastener or mounting device from the application of 250 lbf shall be less than the allowable lateral load of either the fastener or mounting device or the supporting structure, whichever is the smaller allowable load. (4) Tensile force induced in a fastener by a direct tension force of 250 lbf plus the maximum moment from the application of 250 lbf shall be less than the allowable withdrawal and the supporting structure.

To support the required 250 pound load, grab bars should be screwed directly into wall studs, concrete block, or into blocking provided between wall studs. Grab bars have been known to fail in shear, so the fastening of the grab bars should be able to resist shear forces as well as bending and tensile forces. It may be necessary to field test for grab bar strength.

When grab bars must be installed on partitions, the fabricated partitions should be factory reinforced for their full width.

## Wall Reinforcement



### Grab Bars at Toilet

Grab bars make it possible for people who might otherwise need assistance to use toilets independently and safely. Grab bars help people using wheelchairs to transfer onto the toilet and provide assistance to older people who may have difficulty getting up from the seat.

### Grab Bar Location

Provide two grab bars at the toilet, one beside the toilet and one behind the toilet. MAAB requires grab bars to be 30 inches above the floor, while UFAS specifies grab bars between 33 and 36 inches above the floor. It is recommended that the 30 inch measurement is used because it is what people in Massachusetts expect. However, when a tank toilet is used, raise the grab bar 3 inches above the tank so that someone can wrap his or her hand around it.

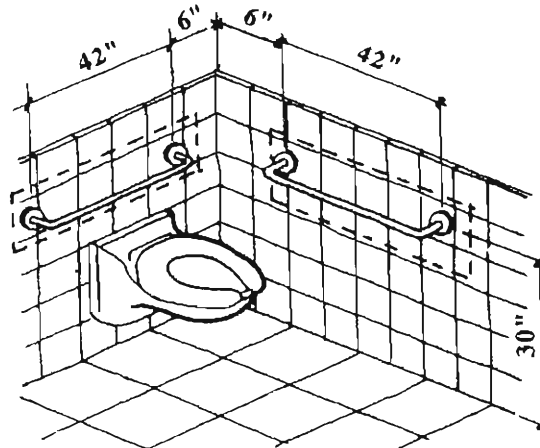

**Grab Bar Locations**

Where a flush valve interferes with the grab bar installation, the grab bar should be split and installed on either side of the flush valve.

*MAAB 30.5.4 (Each toilet room shall have at least one stall which has two grab bars 42 inches long, one on the wall in back of the water closet and one on the side wall closest to the water closet. (Grab bars shall) be set at a height of 30 inches above and parallel to the floor. Where a tank prevents location of the rear grab bar, a bar may be installed 3 inches above the tank. Grab bar ends shall be located 6 inches from the corner of the wall.*

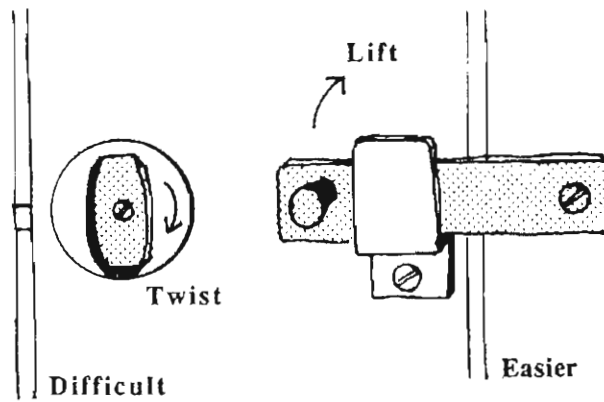

Door Hardware

MAAB 30.5.2...A coat hook shall be provided at a maximum height of 54 inches above the floor.

Locate the coat hook in the accessible stall no higher than 54 inches, within reach of someone in a wheelchair or a short person.

Adding a sink to an accessible stall is a nice feature and offers more privacy for personal care. For example, some people who wear leg bags would like to be able to empty the bag and wash and dry their hands in private. Be sure that the sink does not interfere with the 60 inch by 72 inch clear space needed for the toilet transfers. A larger stall may be required.

Accessible Stalls with Sink

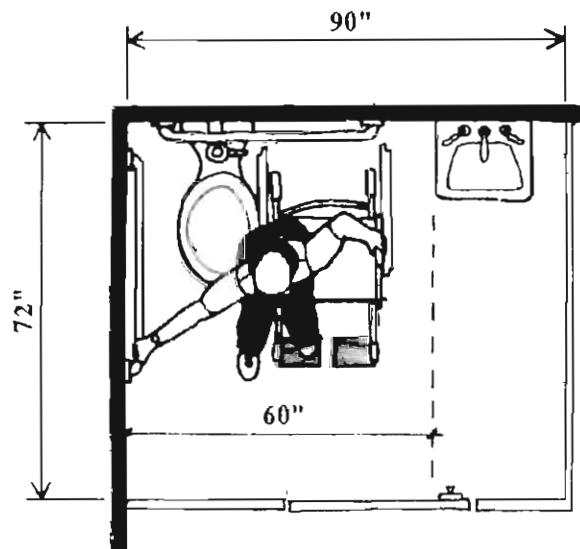

Accessible Stall With Sink

### Stall Door

The door must have 18 inches latch side clearance and a 36 inch wide door.

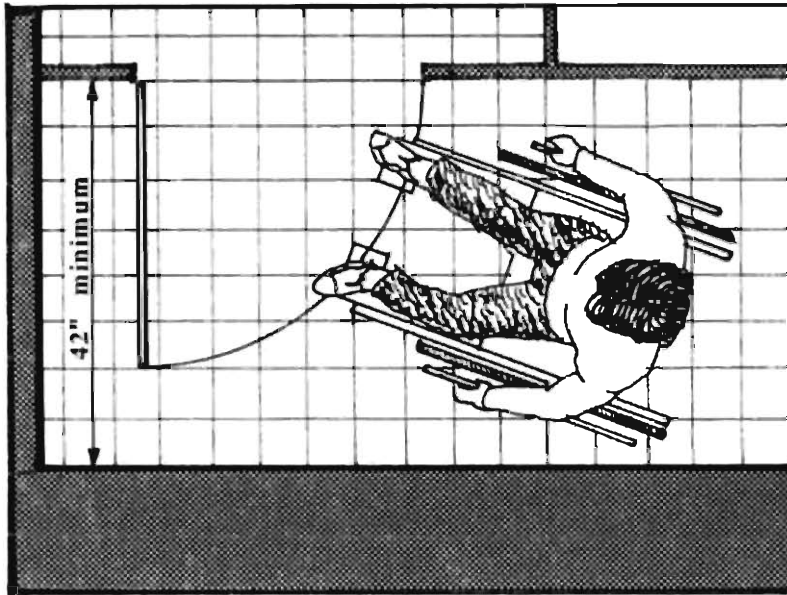

Stall Door

### Stall Door Hardware

For people who lack dexterity, the latch and lock on the stall door must be operable with one hand without tight grasping, pinching or twisting of the wrist. The hardware should be mounted about 36 inches above the floor.

Proper hardware makes it easier to close the stall door. Use self-closing hinges on in-swinging doors. On stall doors that swing out, install a pull device on the inside of the door to help someone in a wheelchair pull the door closed behind him.

For all toilet stalls, specify a door latch that can be operated with a closed fist. Knobs that need to be turned or twisted are difficult for people with arthritis or those who use prostheses to operate. A slide bar or a swinging bar can be lifted easily with minimal finger dexterity.

*UFAS 4.17.5 Doors. Toilet stall doors shall comply with 4.13. If toilet stall approach is from the latch side of the stall door, clearance between the door side of the stall and any obstruction may be reduced to a minimum of 42 inches.*

*MAAB 30.5.2 ...has a door or opening that is 36 inches, swings out or slides, and has an automatic self-closing hinge device and a pull device to assist in closing the door, provides 18 inches of clear space on the latch pull side of the door, and has a lock located approximately 36 inches above the floor.*

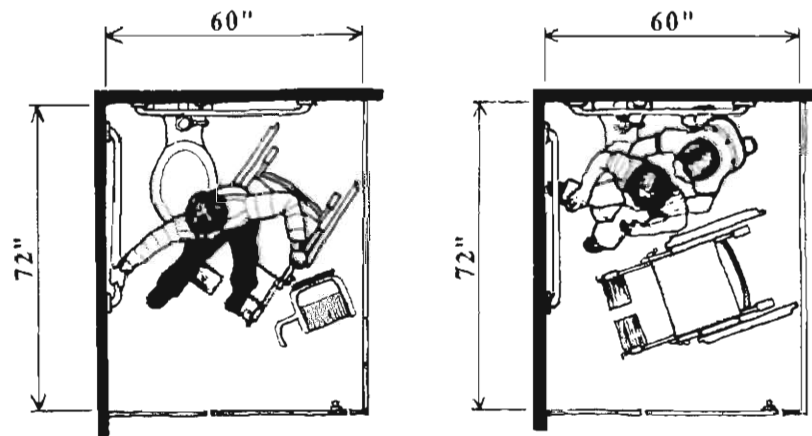

60 Inch Toilet Stalls

*MAAB 305.3 ...locates the water closet 18 inches from the centerline of the fixture to the nearest side wall; maintains at least 42 inches clear space, measured from centerline of water closet to the farthest wall or other fixture;*

An accessible toilet stall needs to be at least 60 inches wide and 72 inches deep. The location of the toilet, with its centerline 18 inches from the side wall, allows someone to reach the grab bars when transferring from a wheelchair to the toilet. Since most people pull their wheelchair up beside the toilet and make a parallel, side transfer, it is imperative that the 42 inches on the other side of the toilet be completely clear.

**Accessible Stalls**

If the stall is only 60 x 72 inches the stall door should swing out. However, the door may swing in if it does not swing into the 60 x 72 inch space.

If the stall door swings out and the approach is from the hinge side, the aisle should be at least 48 inches wide. If the stall door swings out and the approach is from the latch side, the aisle can be 42 inches wide.

When combining two existing stalls to create an accessible stall, be sure that the loss of a toilet does not violate the fixture requirements of the Plumbing Code. As long as a 60 x 60 inch clear space in the stall is maintained, you can place a lavatory in the stall to help the fixture count.

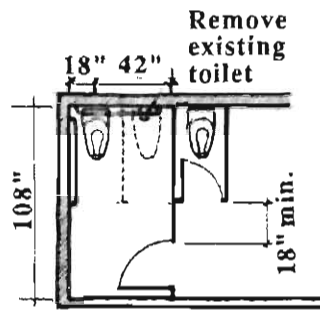

**Combining Two Stalls**

**Toilet Stalls**

There must be at least one accessible toilet stall and toilet in each toilet room.

There are two types of toilet stalls supportive to people with disabilities. A 60 inch wide toilet stall allows plenty of room for moving a wheelchair around, and provides space for an attendant or for a parent with children. At least one 60 inch stall must be provided.

*UFAS 4.23.4 Water Closets. If toilet stalls are provided, then at least one shall comply with 4.17; its water closet shall comply with 4.16...*

*MAAB 30.5 Toilet stalls. Each toilet room shall have at least one stall which:*

*MAAB 30.5.1 ...is 60 inches wide and 72 inches deep;*

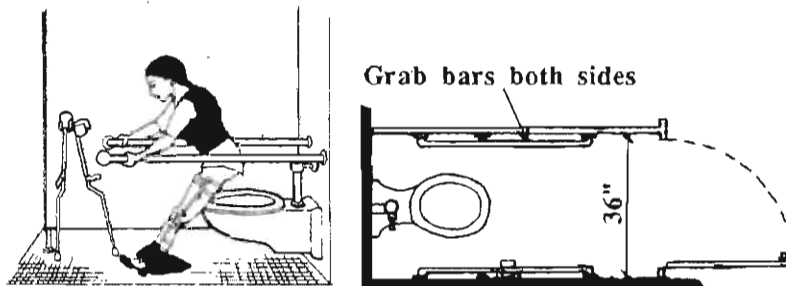

**36 Inch Stall**

A 36 inch wide stall is also useful, particularly to people who have difficulty sitting down and getting back up again, including older people, people wearing leg braces, and pregnant women. Wherever possible, provide a 36 inch stall with grab bars in addition to the 60 inch stall.

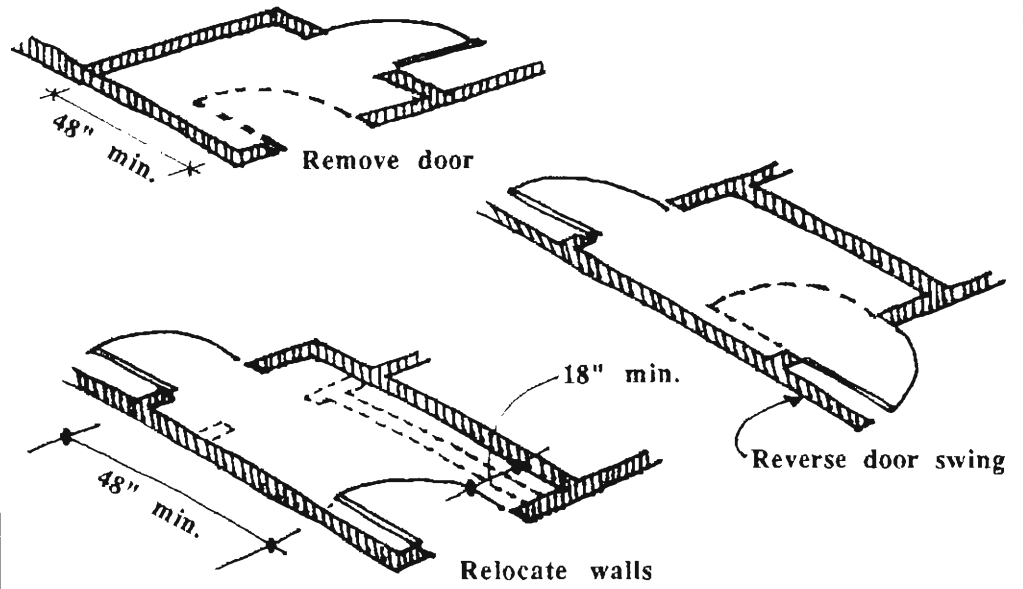

Existing Vestibule Modifications

UFAS 4.2.3 Wheelchair Turning Space. The space required for a wheelchair to make a 180-degree turn is a clear space of 60 inch diameter or a T-shaped space.

In new toilet rooms, provide maneuvering space within the toilet room for someone using a wheelchair when the room is occupied by other people. There should be at least a 48 inch wide pathway between the toilet stalls and the sinks. In addition, provide a 60 inch diameter space so that somebody in a wheelchair can turn around.

Maneuvering Space

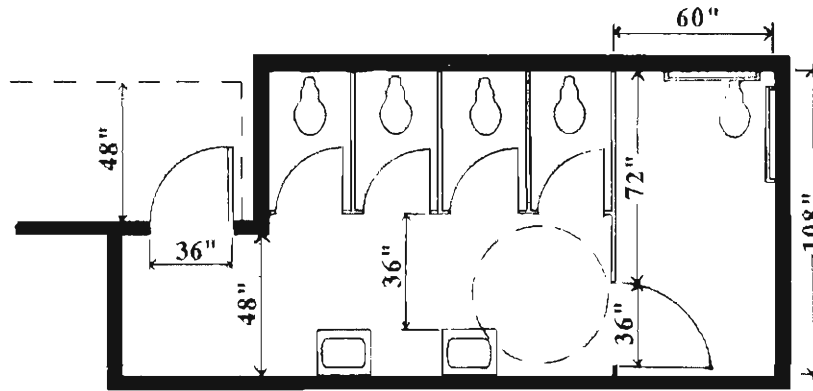

Accessible Toilet Room Layout

If two doors in series are required to ensure privacy within the toilet room, provide enough room between the two doors for someone using a wheelchair to let one door close before opening the next. (See "Vestibules," page 49.)

MAAB 30.2 Where vestibules are provided, they shall comply with Section 26.3.

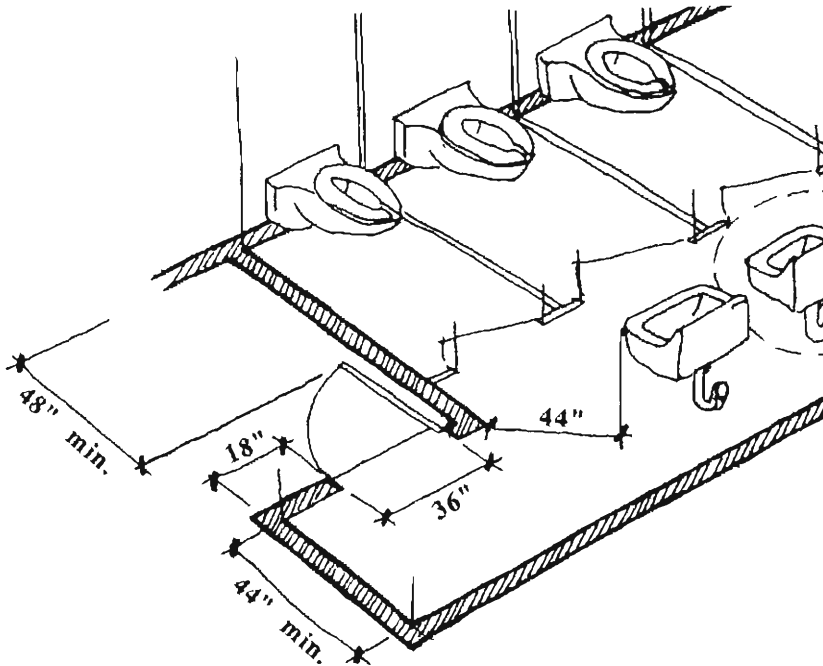

Accessible Vestibule

If possible, provide privacy through the use of walls and only one door. The space between the walls and the door *must* be large enough for a wheelchair to maneuver. A 48 inch clear space plus the depth of the door swing is essential on the pull side of the door. If a turn must be made, a 60 x 60 inch clear space should be provided. There must also be at least 18 inches of latch side clearance on the pull side of the door. (See "Doors and Doorways," page 95.)

### Existing Vestibules

Existing vestibules with in-swinging doors often are easy to enter, but impossible to exit. Sometimes the vestibule can be made accessible by reversing the door swing or removing the door entirely. Some, on the other hand, require the relocation of walls to make the space large enough for maneuvering a wheelchair.

## Public and Employee Toilet Rooms

Accessible toilet rooms sometimes determine whether or not a person with disabilities can use MBTA facilities or be employed with the MBTA. Without accessible toilet facilities, many people have a limited amount of time that they can risk being away from home.

While MAAB does not cover employee areas, UFAS does. Therefore both public and employee toilet rooms must be accessible. Although technically, employee toilets do not have to comply with MAAB, they must comply with UFAS. To avoid confusion, this chapter describes a toilet room which satisfies both codes. The differences between the two codes' requirements are small, and complying with MAAB in all toilet rooms (public *and* employee) will avoid confusion for patrons who have come to expect the MAAB standards.

Following are some common problems found in existing toilet rooms:

- entry door is too narrow
- entry vestibule is too small
- inadequate maneuvering space beside the latch on the pull side of the entry door
- stall is not large enough
- stall door latch is difficult to operate
- stall door is difficult to pull shut
- toilet is in the center of the stall
- grab bars are incorrectly located
- toilet paper dispenser is out of reach
- coat hook is too high
- urinal is mounted too high
- inadequate knee clearance under the lavatory
- sink faucets are hard to operate
- accessories, including mirrors, are mounted too high

Most toilet rooms are designed with a series of walls and doors intended to provide visual privacy within the toilet room. This configuration, which is often unnecessary, limits maneuvering room at the entry, making the toilet room inaccessible to people using wheelchairs.

**Entry  
Vestibule**



*UFAS 4.18.4 Flush Controls. Flush controls shall be hand operated or automatic, and shall comply with 4.27.4 and shall be mounted no more than 44 inches above the floor.*

*MAAB 30.4 One lavatory or sink shall be wall-mounted without legs or pedestal at a height of 32 inches to the top of the rim or counter, and shall extend at least 22 inches from the wall; or may be a counter type with clear open knee space of 30 inches in width and at least 27 inches in height to the bottom of the counter. Exposed drain pipes and hot water pipes shall be recessed, insulated or guarded.*

*UFAS 4.19.2 Height and Clearances. Lavatories shall be mounted with the rim or counter surface no higher than 34 inches above the finished floor. Provide a clearance of at least 29 inches from the floor to height bottom of the apron. Knee and toe clearance shall comply with Fig. 31.*

Be sure that flush controls are hand operated or automatic and are mounted no more than 44 inches above the floor. They should not require any tight grasping, pinching, or twisting of the wrist.

Using uniform sinks which meet the accessibility requirements saves money and simplifies the design. The code specifications for toilet room sinks can be met using standard plumbing fixtures and components. Stigmatizing "handicapped" sinks are not needed to meet code requirements and should be avoided because of their institutional look.

Standard sinks can be used as long as they meet the following requirements:

- the height from the floor to the rim is 32 inches
- the clearance height from the floor to the underside of the sink apron is 29 inches
- the knee space is at least 30 inches wide and 22 inches deep
- the faucets are operable with one hand, closed fist

All sinks should be installed at 32 inches. When built-in counter-top sinks are used, it is helpful if the sink is placed as close to the front edge of the counter as possible to make it easier for a seated person to reach the faucets.

**Flush Controls**

**Sink Type**

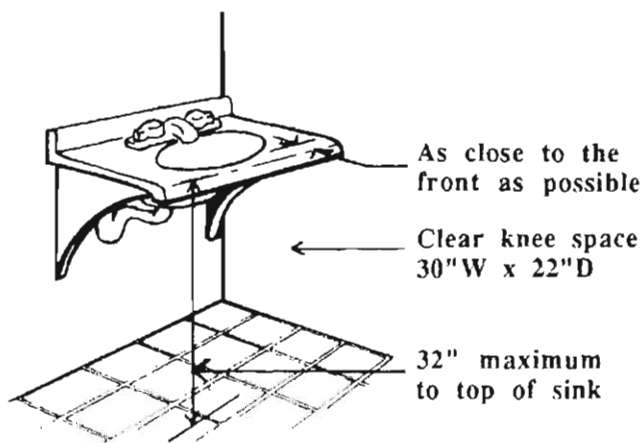

Standard Accessible Sink

### Faucet Controls

People with arthritis, and people with no hands or artificial limbs often cannot grasp a round faucet knob. A lever handle makes it possible for them to turn the water on and off. Use a single lever faucet whenever possible.

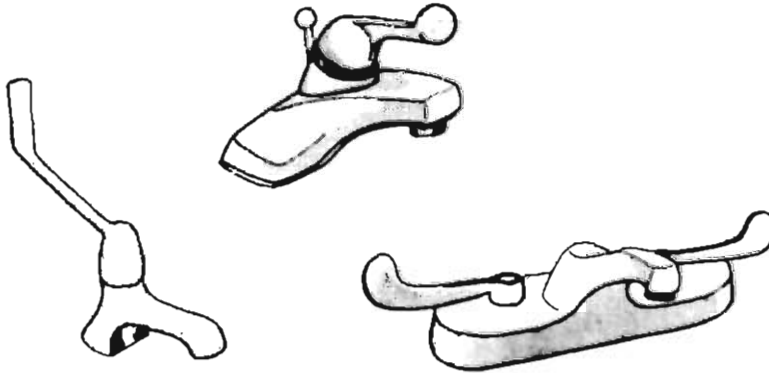

Faucet Controls

### Pipe Protection

Drain pipes, traps, and hot water pipes under sinks become hot enough to burn wheelchair users who have no sensation in their legs. Any sink usable by someone in a wheelchair must have pipe protection. Protection can be provided by wrapping insulation around the pipes or enclosing the pipes. However, when the trap needs servicing, insulation is likely to be removed and not replaced. For this reason, enclosing the pipe area is the preferred solution.

*UFAS 4.19.5 Faucets. Faucets shall comply with 4.27.4. Lever-operated, push-type, and electronically controlled mechanisms are examples of accessible design. Self-closing valves are allowed if the faucet remains open for at least 10 seconds.*

*UFAS 4.19.4 Exposed pipes and surface. Hot water and drain pipes under lavatories shall be insulated or otherwise covered. There shall be no sharp or abrasive surfaces under lavatories.*

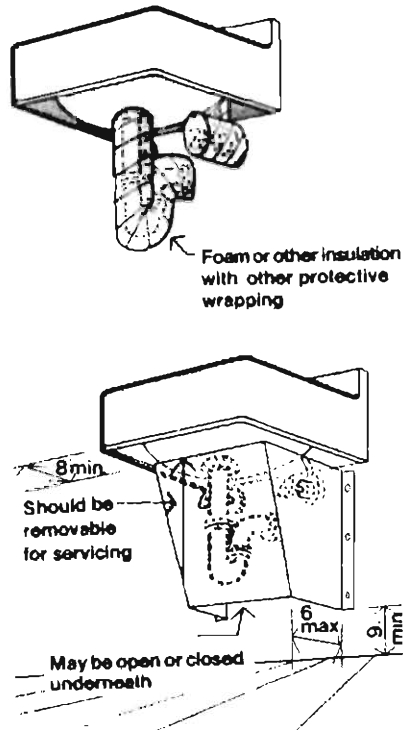

Enclose the pipe area under the sink with a protective cabinet carefully designed to meet the clearance requirements mentioned above.

This protective shield should be removable for servicing. In toilet rooms with a row of sinks, it may look best to have all of the sinks identical. Manufactured cabinets which meet the specifications for clearances under the sink are available.

### Enclosed Pipe Area Beneath Sink

*MAAB 30.8 Dispensers: Towel dispensers, drying devices, or other types of devices and dispensers shall have at least one of each device mounted at a maximum height of 42 inches above the floor, and at least one of each device shall be located within reach of the accessible lavatory.*

*UFAS 4.22.7; 4.27 Operation. Controls and operating mechanisms shall be operable with one hand and shall not require tight grasping, pinching, or twisting of the wrist. The force required to activate controls shall be no greater than 5 lbf.*

It is difficult for someone sitting in a wheelchair to reach across the sink to a soap dispenser. Locate soap dispensers where they will be easily reached on side walls adjacent to accessible sinks. If they are mounted to the counter surface, place them as close the front of the counter as possible.

Paper towel dispensers, hot air dryers, sanitary napkin dispensers, and waste receptacles are often mounted too high for wheelchair users and children to reach. The operable portion of each of these types of dispensers should be located no higher than 42 inches above the floor. In existing buildings where dispensers are too high, add additional dispensers in reachable locations.

Because many people lack dexterity and strength in their fingers, dispensers should be operable with one hand without any tight grasping, pinching, or twisting of the wrist.

**Soap  
Dispensers**

**Other  
Dispensers**

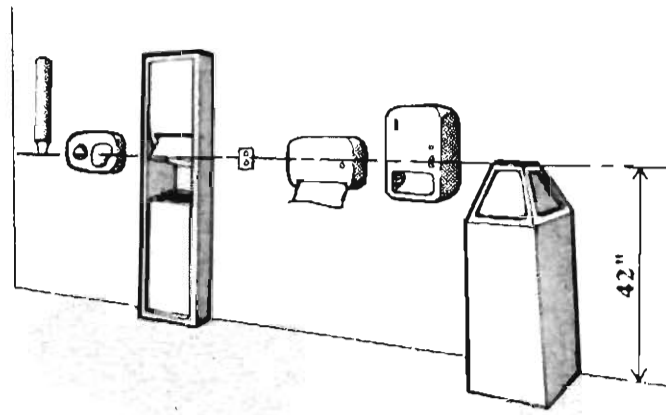

Accessible Dispensers

**Mirrors**

A full-length mirror works well for everyone. Most mirrors above sinks are too high for people in wheelchairs to see themselves. Tilted mirrors installed especially for wheelchair users are too low for tall people and also give an institutional appearance to the toilet room. To be usable by a person seated in a wheelchair, the bottom edge of at least one mirror in the toilet room should be no higher than 40 inches from the floor.

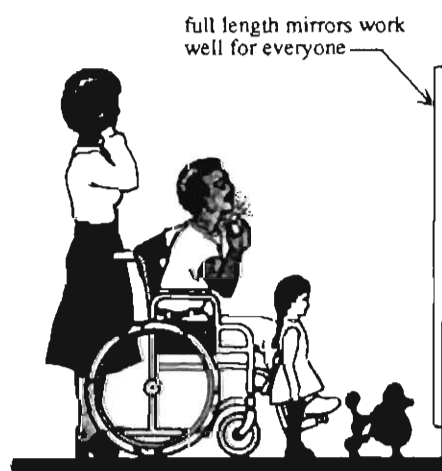

Full-Length Mirror

*UFAS 4.23.6 If mirrors are provided, then at least one shall comply with 4.19.*

*UFAS 4.19.6 Mirrors. Mirrors shall be mounted with the bottom edge of the reflecting surface no higher than 40 inches from the floor.*

MAAB 30.1 In each toilet room at least one water closet and one lavatory shall be accessible to persons in wheelchairs, or an accessible private lavatory, usable by either sex, shall be provided.

In an existing building where the toilet rooms are inaccessible and difficult to modify it is sometimes more economical to construct an entirely new accessible toilet room. A "unisex" toilet room is generally not allowed by the Plumbing Code. But if it is provided in addition to men's and women's toilet rooms, it can be justified because it allows a husband to assist his wife, or a mother to accompany her young son. This is an especially useful solution when the modification of existing toilet rooms would require a reduction in the number of fixtures, and result in the building not meeting the Plumbing Code.

**Private Toilet Room**

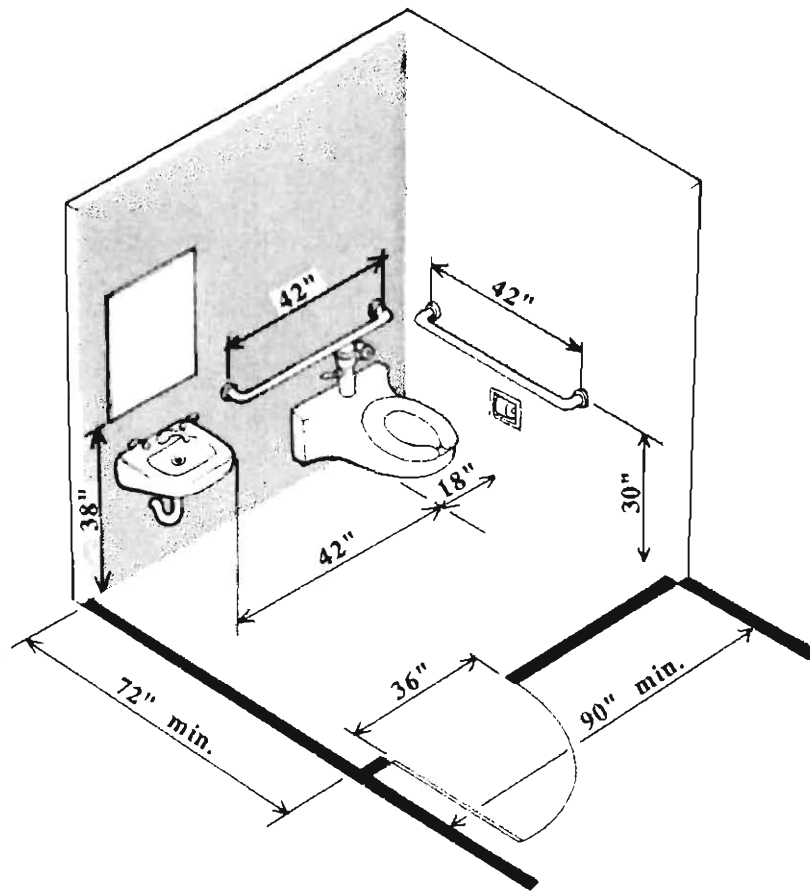

**Private Toilet Room**

# 4

## COMMUTER RAIL STATION ACCESS

# COMMUTER RAIL

**Introduction** ■

**Site** ■

**Platform** ■

**Track Crossing** ■

**Station House** ■

## Introduction

Commuter Rail stations have a set of design considerations not shared by heavy or light rail rapid transit: they are often in rural settings; they share tracks with Amtrak, Conrail, freight and Civil Defense trains; and the elements of the station are not always owned by the MBTA. This chapter covers only those issues which are unique to the commuter rail. Design features which are common to both commuter rail stations and heavy rail stations are covered in Chapter 3. When appropriate, readers will be referred to the appropriate section of that chapter.

All parts of a commuter rail station which are specifically being renovated must comply with applicable access codes. For example, where work is being done to repair or replace existing platforms, an access platform is required by the MAAB. Even when the work does not require full compliance throughout a station, special attention to providing an accessible path of travel to the platform is essential. Station peculiarities may mean that non-standard approaches will be required; where these go beyond the scope of the regulations, variances must be obtained before the design is complete. Differing requirements of the entities owning or controlling rights-of-way and property means that each station project must be coordinated to ensure complete accessibility.

Although the MAAB has made some recent developments in commuter rail station policy, many commuter rail issues are not covered by code. For example, overpass coverings are addressed only in MBTA Design Guidelines or memoranda. It is the goal of these design guidelines to bring the pieces together into an integrated whole.

It is likely that standards will continue to develop even after these guidelines are published. Developments will be published as addenda to this book and should be inserted into this binder.



### **New MAAB Commuter Rail Regulations**

The Massachusetts Architectural Access Board (MAAB) has established new regulations on commuter rail station accessibility. At newly constructed commuter rail stations, or stations which are being reopened after 5 years or more of providing no passenger service, full-length raised platforms are to be provided. When stations that are currently in use are renovated, an access platform serving at least two cars of the train must be provided. Further details are discussed in the platform section of this chapter. Code references in this chapter refer to the UFAS and MAAB regulations last published before the new additions. (*For the text of the new regulations, see Appendix B.*)

### **Jurisdiction Issues**

Ideally, all parts of a station undergoing renovation would be made accessible. However, elements of the station may not belong to the MBTA; parking lots are sometimes owned by the town, and the station house and vendors are frequently privately owned. Before any design work for a new or existing station takes place, ownership of station elements should be determined. Agreements with owners of other properties are necessary to create complete accessibility.

### **Organization of Chapter**

This chapter follows the typical route of travel through the station and onto the train, and is divided into the following sections:

1. Site
  - Station Layout
  - Parking
  - Passenger Loading Zone
  - Pathways
2. Platform
  - Full-Length Raised Platform
  - Access Platform
  - Shelter
3. Track Crossing
4. Station House

## Site

Accessible features of a commuter rail station should be grouped when possible. Locating the accessible parking spaces, the access platforms, and the track crossing in close proximity to each other minimizes the length of the route a mobility impaired person must travel to use the station. Such an arrangement minimizes maintenance efforts and provides convenient access to the station. If an overhead track crossing is used, bridging between the two access platforms minimizes the amount of ramp that must be built. Also, people using wheelchairs will be relieved to exit the overhead crossing right at the parking spaces.

## Station Layout

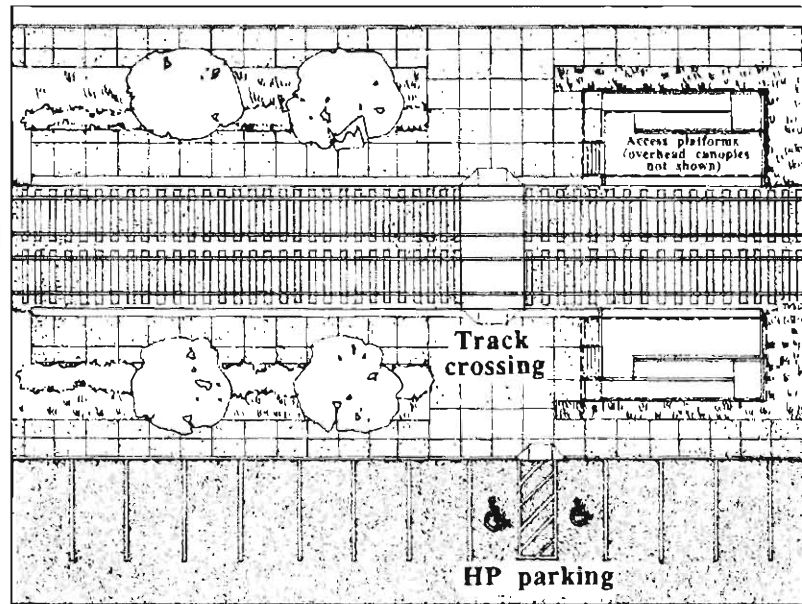

Accessible Commuter Rail Station

### Parking

Many commuter rail stations have multiple parking lots, sometimes located on both sides of the tracks. Generally, accessible spaces must be distributed proportionally among all lots unless a special arrangement with the Access Board is made. However, at a commuter rail station, the sum total of the parking spaces required on one side of the tracks may be consolidated in the lot closest to the station. At least one lot on *each side* of the tracks has to supply the requisite number of accessible parking spaces. To determine the required number of accessible parking spaces, compute the numbers on a lot by lot basis and add them together. Sufficient signage must be used in the auxiliary lots to direct people to the accessible spaces.

The Office of Transportation Access recommends at least one van space in lots with less than 500 spaces, and at least two van spaces in lots with 500 or more spaces. Signage at these spaces should designate them as van spaces. (*For van space dimensions, see "Parking Space Size," page 26.*)

HP spaces should be conveniently located near the access platforms, the station house or by track crossings. If the main accessible station features are not grouped together, HP spaces can be distributed if greater access is achieved.

In lots where cash boxes are used, one of several ways to assure accessibility should be used: 1) if there is only one location for the cash box, make sure it is on the accessible route of travel; 2) locate and number HP spaces so that their cash box slots are between 36 and 48 inches; 3) if the cash boxes cannot be located on an accessible route of travel, locate cash boxes at the HP spaces.

All HP spaces should be connected to a safe, accessible route of travel that is marked.

The dimensions of the accessible parking spaces at commuter rail stations must meet the same requirements as those in rapid transit parking lots. (*See "Parking Space Size," page 26.*)

### Passenger Loading Zones

An accessible passenger loading zone provides a safe route of travel to the platform without forcing a wheelchair user or any other commuter to cross vehicular traffic.

*MAAB 23.2 Specially designated parking spaces for the physically handicapped shall be the closest located spaces in the lot to the accessible entrance(s)...*

*MAAB 23.8 Walks and ramps required as a means of egress leading from specially designated parking spaces for the handicapped in parking lots, garages, or other parking facilities, shall be in conformity with all sections of these Regulations.*

MAAB 23.2 ...Where the designated parking space cannot be located within 200 feet of the accessible entrance(s), an accessible drop-off area shall be provided within 100 feet of such entrance(s).

MAAB regulations require a passenger loading zone within 100 feet of the accessible entrance when it is not possible to have accessible parking spaces 200 feet from the accessible entrance. In commuter rail stations this distance is measured from the station platform to the parking spaces or passenger loading zone. To prevent a long and confusing path of travel, passenger loading zones are best located close to the access platform and/or the accessible station house.

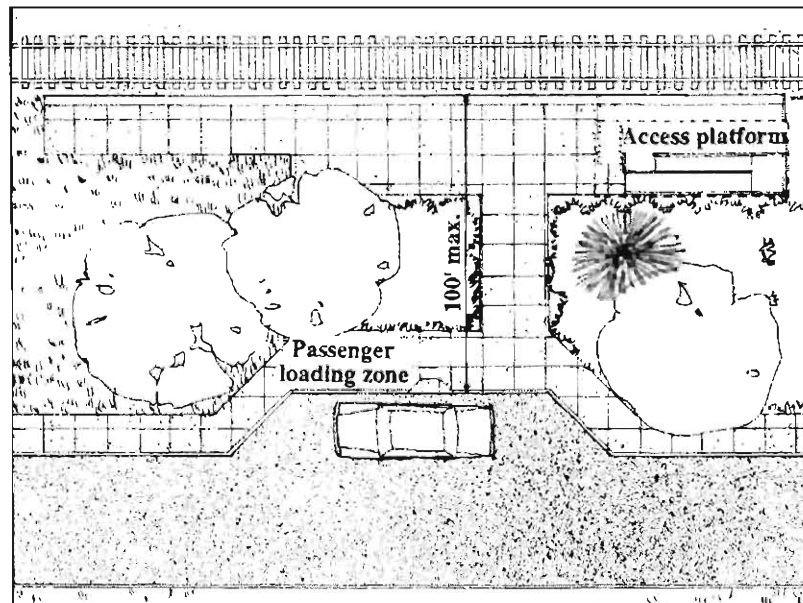

**Passenger Loading Zone at Access Platform**

Passenger loading zones at commuter rail stations must meet the same requirements as the rapid transit passenger loading zones. (See "Passenger Loading Zone," page 31.)

### Pathways

Commuter rail stations are often located in areas with very little pedestrian traffic, yet a safe, accessible path of travel for those not arriving by car must be provided. The new MAAB regulations of September 1990 address accessible routes of travel: "18.6.5 At all newly constructed, reconstructed, altered or remodeled stations, an unobstructed continuous path of travel shall connect all terminal buildings or station houses, platforms, parking areas designated for use by handicapped persons, and street entrances." If the accessible route of travel deviates in any way from the main flow of pedestrian traffic, it should be clearly marked with signs.

Some stations have no "entrance" except where vehicles enter and exit the station. The design should establish an **accessible pedestrian route** of travel free of stairs or steep slopes from the street to the station and platforms. Careful thought must be given to provide a safe route of travel out of the line of vehicular traffic. Where sidewalks are not provided and pedestrians must travel through the parking lot, it is recommended that a pedestrian aisle be designated with lines painted on the asphalt and signage visible by drivers. This should extend from the parking lot entrance to the accessible elements. This pedestrian aisle would alert drivers to the presence of people in wheelchairs or others who are sometimes difficult to see.

These accessible routes of travel must meet the design requirements described in Chapter 3. (See "Accessible Route," page 33.)

*MAAB 18.6.5 At all newly constructed, reconstructed, altered or remodeled stations, an unobstructed continuous path of travel shall connect all terminal buildings or station houses, platforms, parking areas designated for use by handicapped persons, and street entrances.*

*UFAS 4.3.2 (1) At least one accessible route within the boundary of the site shall be provided from public transportation stops, accessible parking, and accessible passenger loading zones, and public streets or sidewalks to the accessible building entrance they serve. (2) At least one accessible route shall connect accessible buildings, facilities, elements, and spaces that are on the same site. (3) At least one accessible route shall connect accessible building or facility entrances with all accessible spaces and elements...*

*MAAB 22.2 Such walks and walkways shall have continuous common surfaces, not interrupted by steps or abrupt changes in level greater than 1/2 inch.*

## Platform

Standard platform design features covered in Chapter 3 must be observed. (See "Platform," page 107.) However, commuter rail platforms have some unique challenges which are discussed in this section. On several lines, commuter rail platforms must provide access while accommodating wide load clearances. Some freight trains and civil defense (Stracnet\*) trains require clearances greater than the standard 5'7". Exact clearances for all stations should always be obtained from the MBTA prior to design. This section contains options for resolving the access question.

### Clearance Requirements: Non-Standard Stations

Line	Station	Clearance*	Reason
Gardner	Ayer	8'6"	Freight
	Fitchburg	"	"
	Gardner	"	"
	North Leominster	"	"
	Shirley	"	"
Haverhill	Andover	8'6"/6'6"	Freight/Stracnet
	Ballardvale	"	"
	Bradford	"	"
	Haverhill	"	"
	Lawrence	"	"
Lowell	Lowell	8'6"/6'6"	Freight/Stracnet
	Mishawum	6'6"	Stracnet
	North Billerica	"	"
	Wedgemere	"	"
	West Medford	"	"
	Wilmington	"	"
	Winchester	"	"

\* from edge of platform to centerline of tracks

\* Stracnet refers to the Civil Defense train system which requires a 6'6" minimum clearance.

### Full-Length Raised Platforms vs. Access Platforms

Full-length raised platforms and access platforms both provide platform-to-vehicle access suitable for people who use wheelchairs or other mobility aids. But access platforms serve only two coaches of the train while full-length raised platforms extend for the total length of the train. The MAAB now requires full length raised platforms at all new stations while permitting access platforms at renovated, rebuilt or remodeled stations. Because they increase accessibility, cut dwell time, and improve boarding safety for all passengers, full-length raised platforms may also be appropriate at larger existing stations. However, their high cost and difficulties regarding track rights, freight clearance, and property control sharply limit their use at existing stations.

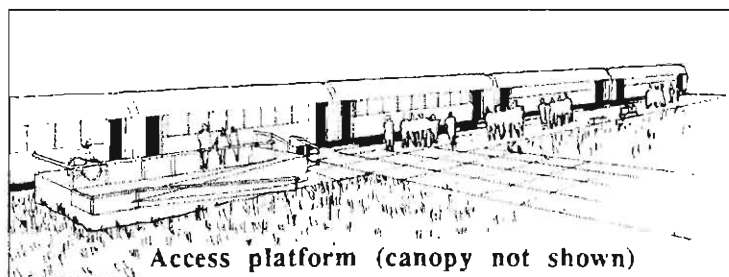
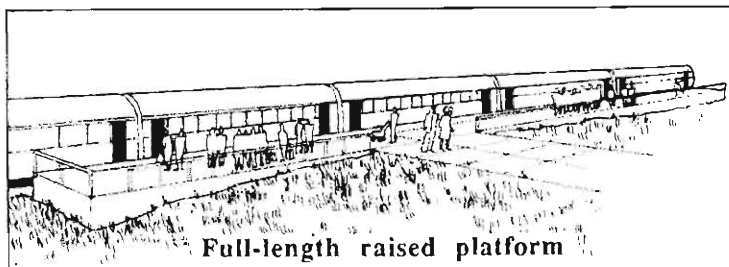

### Access Platform vs. Full-Length Raised Platform

Although full-length raised platforms provide the greatest amount of access, they are sometimes infeasible because of the different platform widths mandated by track uses. Full-length raised platforms are to be provided under the following circumstances:

- when new stations are built
- when platforms are *completely* relocated
- when stations are reopened after having been closed for 5 years or more

Access platforms must be constructed at stations which are not required to have a full-length raised platform when the station is being renovated.

*MAAB 18.6.1 At newly constructed stations serving commuter rail coaches, access shall be provided to all passengers and to all coaches of the train by means of a raised platform....*

*MAAB 18.6.2 Any reconstructed, altered or remodeled stations serving commuter rail coaches shall afford access to at least two coaches of a train by means of a raised access platform....*

*MALB 18.6.4 The edge of all platforms at newly constructed, reconstructed, altered or remodeled stations shall have a yellow band of a different texture, distinguishable underfoot, and at least 24 inches in width, warning of a danger zone.*

Full-length raised platforms must meet the criteria defined for rapid transit stations in Chapter 3. (See "Platform," page 107.)

**Full-Length Raised Platform Design**

Access platforms must also meet the standard requirements for platforms defined in Chapter 3 including the 24 inch tactile and visual edge treatment. (See "Platform," page 108.) Issues which are unique to access platforms are discussed below.

**Access Platform Design**

Location of access platforms must be consistent throughout the commuter rail system so that passengers relying on them know which cars to board at full-length stations (such as the terminals at North Station, South Station and Back Bay). Consistency also facilitates the placement of accessible coaches equipped with wheelchair tie-downs at the access platform. For operational and safety reasons, the MBTA has chosen to place the access platforms at the "country end" of the station: the first two cars of an outbound train and last two cars of an inbound train stop at the access platform. Markers for positioning trains are utilized to help place a set of double doors at the access platform.

**Placement of Access Platforms**

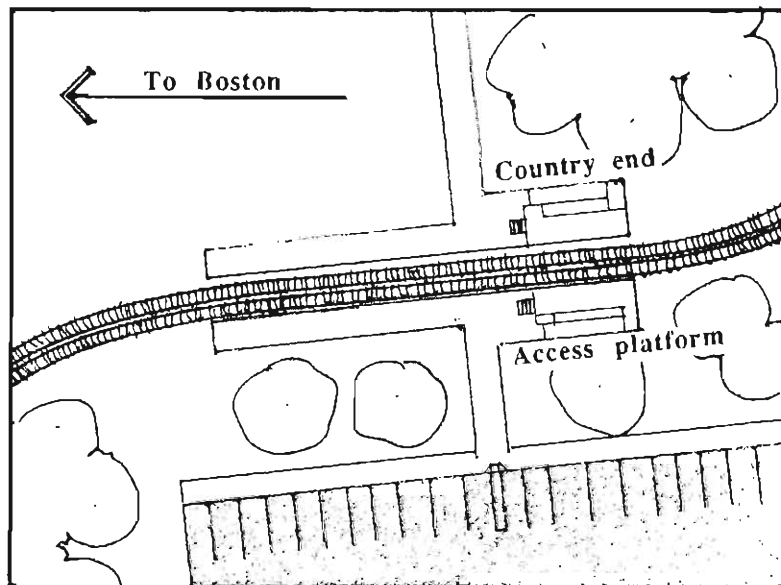

**Placement of Access Platform at "Country End"**



Operational policy requires all trains to stop at the access platform. Because trains differ in length, the train itself or the operating cars of non-rush hour trains may stop some distance from the “city end” of the station. For this reason, station amenities such as shelters should be biased towards the country end of the station where the train will always stop. This should also be considered when designing routes of travel.

### Access Platform Height

The surface of access platforms must be 48 inches above the top of the rails. At 48 inches, the platform will be level with the floor of the car, making it easy for a person with a mobility impairment to board the train.

### Access Platform Dimensions

The access platform shall be 48 inches above the top of the rail. A length of 45 feet is required to provide service to adjacent doors.

The access platform must have at least 5 feet of clear width. Careful placement of platform amenities should ensure that the 5 foot clear width is maintained along the entire length.

Standing dimension for a wheelchair is 30 x 48 inches. Where turns must be made, maintain at least a 60 x 60 inch space or a T-shaped space.

There should be a 30 x 48 inch clear space next to seating so that a person seated in a wheelchair can pull up alongside a friend.

*MAAB 18.6.2 ...Such platforms shall be at least 45 feet in length and at least 5 feet in clear width...*

*UFAS 4.2.4.1 The minimum clear floor or ground space required to accommodate a single, stationary wheelchair occupant is 30 by 48 inches...*

*UFAS 4.2.3 The space required for a wheelchair to make a 180-degree turn is a clear space of 60 inches diameter or a T-shaped space.*

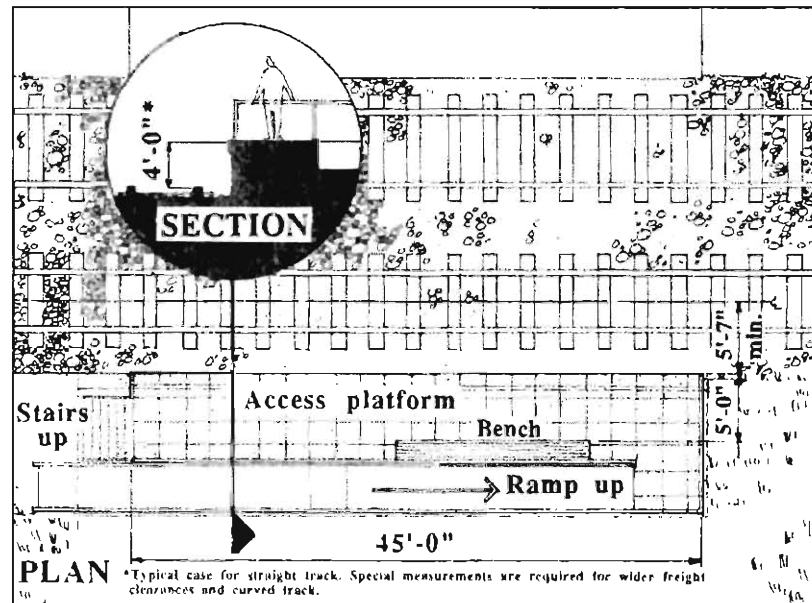

Access Platform Dimensions

MAAB 18.6.3 The distance between the raised platforms...or the raised access platform... and the floor of the entrance to the rail coach shall not exceed 4 inches in the horizontal plane and 2 inches in the vertical plane. Where construction constraints result in platform to vehicle gaps that exceed these standards, a bridge plate designed to eliminate such gaps shall be made available at every door of the vehicle where passengers are boarding or disembarking.

The standard distance between the centerline of the tracks and the edge of the platform is 5 feet 7 inches, unless wide load passage or track curvature necessitates a greater clearance. (See chart, page 161.) The maximum car/platform gap allowable by the MAAB is 2 inches in the vertical plane and 4 inches in the horizontal. When the distance from the platform to the centerline of the tracks is greater than 5 feet 7 inches, resulting in a greater gap between the car and the platform, some means of closing the gap must be used. On-train bridge plates, currently in use on commuter rail coaches, are generally the preferred option for closing the gap between the car and the platform.

Car/Platform Gap

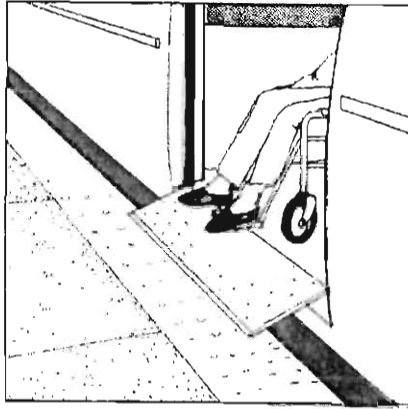

**Bridge Plate**

A second set of tracks which could provide clearance around the access platform has also been considered. Another possibility is a folding edge on the access platform. In most circumstances, wide loads can be scheduled in advance, leaving an opportunity to manually fold up the edge. Designers should be aware of the latest developments when designing an access platform.

### Stairs and Ramps

Stairs and ramps must supplement each other because ramps alone do not meet everyone's access needs. People using crutches or prostheses often have more difficulty accommodating their gait to a ramp's sloping surface than they do climbing stairs. For this reason, the MBTA requires stairs as well as a ramp at the access platform. Stairs and ramps must be code compliant. (See "Stairs," page 75, and "Ramps," page 71.) For level changes from grade to the platform, and for pedestrian overpasses, ramps and stairs must be roofed. For all other cases, it should be determined for each site individually whether stairs and ramps at platforms should be roofed. (See "Accessible Route," page 34.) Vertical or inclined platform lifts are not an option, since they are prone to mechanical failure and vandalism.

### Canopy

The MBTA requires a canopy over the entire access platform and all means of vertical circulation. The distance from the edge of the canopy to the centerline of the track is site-specific, and must be determined on a case by case basis.

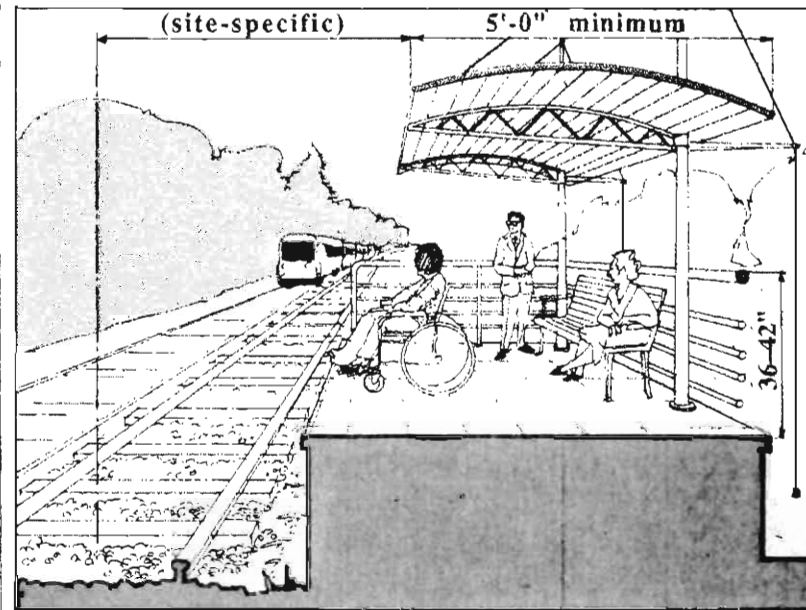

**Canopy, Railings, and Amenities**

Access platform railings are not covered by the MAAB or UFAS. The railings should be set along three sides of the platform at a height between 3 to 42 inches to the top of the rail. Gaps between horizontal, vertical or other rail elements should be no more than 6 inches wide.

#### **Railings**

The access platform should be attractive to all riders so that people using wheelchairs do not feel isolated and "on stage." All amenities provided at the station must also be provided on the access platform. These may include newspaper machines, telephones, and police call boxes.

#### **Amenities**

The amenities should not reduce the effective clear width of the platform. They should not be placed in front of signage. (See "Platforms," page 109; "Telephone," page 125; "Signage," page 117.)

**Shelter Location** Shelter is important for the safety and comfort of all commuters. In addition to the shelter above the access platform (See "Canopy," page 166), the new MAAB regulations call for 150 feet of overhead shelter at all full-length, high-level platforms. (See Appendix B for the new regulations.)

**Existing Shelters** Many existing shelters are raised up from the platform level and are inaccessible. Even if there is a covered access platform, existing shelters should be made accessible or an additional shelter should be provided for people who are waiting for the train but not boarding it.

**Level Change at Shelter** There should be no level change greater than 1/2 inch between the platform and the shelter unless a ramp is provided. Between 1/4 inch and 1/2 inch, the level change must be beveled with a maximum slope of 1:2.

**Overhead Shelter Dimensions** Roofs should be at least 5 feet deep so that a person using a wheelchair will be completely covered. The higher the shelter roof, the greater the depth should be to prevent rain and snow from falling under the shelter.

*UFAS 4.5.2 Changes in Level. Changes in level up to 1/4 inch may be vertical and without edge treatment. Changes in level between 1/4 inch and 1/2 inches shall be beveled with a slope no greater than 1:2. Changes in level greater than 1/2 inch shall be accomplished by means of a ramp that complies with 4.7 or 4.8.*

**Enclosed Shelters**

*UFAS 4.2.4.1 Size and Approach. The minimum clear floor or ground space required to accommodate a single, stationary wheelchair occupant is 30 by 48 inches...*

*UFAS 4.2.3 Wheelchair Turning Space. The space required for a wheelchair to make a 180-degree turn is a clear space of 60 inches diameter or a T-shaped space...*

If the shelter has walls, the plan should allow maneuvering space and a resting space for a person using a wheelchair. The layout should allow at least two people in wheelchairs to use the shelter without blocking other users. If a turn must be made to position oneself in the shelter, provide a 5 foot diameter maneuvering space. A wheelchair requires a 30 x 48 inch space in the resting position. If seating is provided, leave a 30 x 48 inch clear space at the end of the seat so that a person using a wheelchair can sit next to a friend.

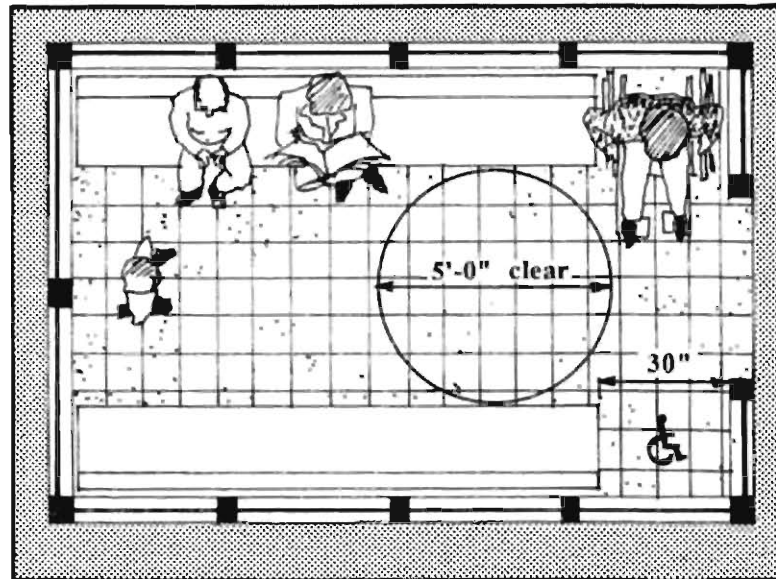

**Enclosed Shelter**

# Track Crossing

Track crossings serve as a link in the accessible route of travel through the station. Achieving both safety and convenience in track crossing is the subject of much discussion between the commuters, the access community, transit authorities and operating railroads. There are three methods of track crossing: at-grade crossings, overpasses, and underpasses.

The MBTA operates on two high speed lines: the Framingham line and the Providence line. Ultimately, the MBTA will eliminate all at-grade crossings on these lines because of the danger a 110 m.p.h. train poses. Whether the crossing is at- or above-grade, the MBTA is considering the use of bells to signal an approaching train so that people will not be startled by a high speed train. As with most aspects of commuter rail access, track crossing methods are determined on a case-by-case basis.

## Pros & Cons of Track Crossing Methods

### AT-GRADE CROSSINGS

#### Pros

- Short and convenient path of travel
- No level changes
- Costs the least

#### Cons

- Minimal pedestrian safety
- Flange gap between the crossing and the rail

### OVERPASSES

#### Pros

- Provides pedestrian safety from high speed trains

#### Cons

- Expensive, usually only one per station is feasible
- Extremely long path of travel
- Path of travel is further increased by the level change
- Level change may be impossible for some people
- Potentially a security problem

### UNDERPASSES

#### Pros

- Provides pedestrian safety from high speed trains
- May be smaller level change than overpass

#### Cons

- Security problem
- Expensive

**At-Grade  
Crossing  
Location**

Crossings should be viewed as the connection between elements of the accessible route. Since it is possible to have more than one at-grade crossing, minimize travel distances by strategic placement of the track crossings, such as adjacent to the passenger loading zone, accessible parking spaces, or access platforms.

**Crossing  
Surface**

At-grade crossings must provide a smooth path of travel from one side of the tracks to the other. Level changes between materials should be no greater than 1/2 inch. If the crossing is lower than the platform, the approach should be a curb cut with flared sides and no slope greater than 1:12. (See "Curb Cuts," page 38.) The curb cut must be painted and roughened to distinguish it visually and texturally from the rest of the platform. This is an extremely important safety feature for people with visual impairments who may otherwise walk onto the track inadvertently.

At-grade crossings are usually made of wood ties, laid perpendicular to the path of travel. Care must be taken to ensure that the lumber is installed level, with no gaps that could trap a cane tip or front wheelchair roller. The flange gap between the crossing and rail must be minimized. In no case should the gap be greater than 4 inches (less whenever possible). It is particularly critical for the surface to be non-slip because a fall on the train tracks could be deadly. The crossing should be a minimum of 96 inches wide.

*UFAS 4.5.2 Changes in Level. Changes in level up to 1/4 inch may be vertical and without edge treatment. Changes in level between 1/4 inch and 1/2 inch shall be beveled with a slope no greater than 1:2. Changes in level greater than 1/2 inch shall be accomplished by means of a ramp that complies with 4.7 or 4.8.*

*MAAB 22.3 Only a non-slip finish material may be applied to any walk or walkway.*



### Safety

Trains do not always travel at a slow speed through commuter rail stations. Some Conrail trains travel at high speeds, and Amtrak trains can travel up to 110 m.p.h. People are often surprised at how quickly these trains can come upon a station. There is often little visual or audible warning. Even a slow-moving train cannot brake effectively for a person on the tracks. Hence, at-grade crossings pose a significant safety hazard. For the two high speed lines, Providence and Framingham, at-grade crossings are being replaced with overpasses.

### Overpass Location

To avoid an excessively long path of travel, the overpass should be located close to the accessible parking spaces and/or the access platform. In some cases, the access platforms may provide the best location for the overpass because the level change is reduced by the two raised platforms. The overpass can then be part of the same accessible route established at the access platforms.

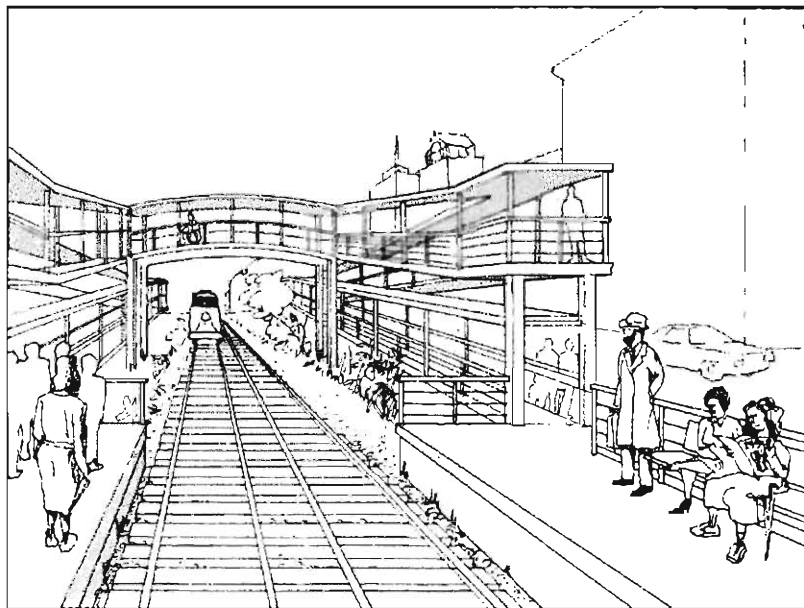

**Overpass Bridging Access Platforms**

MAAB 22.5 Pedestrian bridges, underpasses and overpasses shall be considered as walkways or ramps and shall comply with Sections 22 and 25.

To bridge the over 20 feet of rise at most stations, hundreds of feet of ramp and walkway must be constructed. For a wheelchair user or for someone with low stamina, as well as for people with packages or strollers, such a distance, no matter what the slope, is difficult to travel. Consider using a lesser slope, even though it lengthens the ramp. Also, many people would benefit from a bench at the switchbacks.

**Level Change**

Although some ramps must be covered, care must be taken to ensure that the length of pathway is clear of all snow, ice, and debris. Some localities fear that an overpass could become a crime hazard, just as an underpass could.

Overpass design must meet the standard ramp, stair and pathway requirements described in Chapter 3. (See "Ramps," page 71; "Stairs," page 75; "Accessible Route," page 92.) A ramp must always be incorporated into the design; however, many people find a ramp difficult to travel over a long distance. Therefore, stairs should always be used in conjunction with a ramp. An elevator provides for the most people's abilities and should be included at major terminals. Elevators cannot be used at stations which do not have MBTA personnel present during all operating hours.

**Overpass  
Ramps and  
Stairs**

The overpass and its ramps and stairs must be covered for their entire lengths. Fully enclosing the overpass is not recommended because of safety issues and the excessive heat that can build up in the enclosure.

**Overpass  
Roof**

Underpasses must meet the same slope and surface requirements as overpasses. From the perspective of a wheelchair user, an underpass may be preferable to an overpass because the level change is not as great. (See "Pros and Cons of Track Crossing Methods," page 170.)

**Underpass  
Design**

## Station House

Many existing station houses have neither accessible entrances nor accessible interior facilities (such as toilet rooms, vendors, ticket booths, etc.). New station houses should be designed barrier-free and, when possible, existing station houses should be renovated to provide access to all features of the station. When the station house or parts of it are privately owned, cooperation from these owners may be necessary to produce a fully accessible station. Many station houses are considered historic landmarks. Historic designation does not exempt a building from being accessible, but alternate means of access may be allowed.

**Entrance**      *(See "Entrance," page 47, and "Doors and Doorways," page 95.)*

**Vendors**      *(See "Vendors," page 130.)*

**Ticket Windows**      The ticket window should be made accessible by having enough floor space to allow wheelchair approach, no level change upon approach to the window, and a counter height no more than 40 inches above the floor or ground. Some of the design standards for fare collection booths may apply. *(See "Fare Collection," page 55.)*

**Floor Surfaces**      *(See "Floor Surfaces," page 101.)*

**Toilet Rooms**      *(See "Public and Employee Toilet Rooms," page 133.)*



# 5

## MAINTAINING ACCESS

## Maintaining Access

Accessibility is not ensured just because the building has been designed barrier-free. Building management and maintenance practices will need to be examined to see that they contribute to, rather than erode, the accessible features of the station. This chapter highlights some common problems that arise once a building is in use.

Maintenance is especially important to protect people with disabilities. People with disabilities are particularly vulnerable to a crack in a sidewalk, a stiff door, or a broken elevator. When stations are routinely inspected, the accessible features below should be examined.

A hard-packed smooth surface needs to be maintained at the handicapped parking area and along the accessible route from the parking spaces to the station. Also check to see that painted lines designating handicapped parking spaces and the adjacent 5 foot wide aisle are plainly visible. The lines and the International Symbol of Accessibility painted on the ground at the parking space should be redone if they have faded significantly.

### Parking Lots

Signs at handicapped parking spaces keep non-disabled drivers from using spaces and allow drivers to easily spot the accessible parking spaces. Check to see that the original signs designating the accessible spaces are still posted at each space or pair of spaces and that they are not obstructed.

The wheelchair-accessible route from the sidewalk, accessible parking spaces, or accessible passenger loading zone to the station should be kept free of cracks and level changes from settling materials. Cracks greater than 1/2 inch should be filled in. Level changes between 1/4 inch and 1/2 inch should be beveled with a slope of 1:2. Level changes greater than 1/2 inch need to be eliminated by repairing the materials around it, or by regrading if the problem is extensive.

### Accessible Route to the Station

- Entrance** The accessible entrance must be kept unlocked and open during operating hours. When entrances are being closed, be careful to identify and maintain the accessible entrance.
- The pressure required to open the doors should not exceed 15 pounds. Closers should be adjusted if necessary. Stiff hinges should be repaired or replaced. Check to see that the threshold has not pulled up. It should be no more than 1/2 inch high and beveled with a slope of 1:4.
- Fare Collection** The fare collection booth closest to the accessible entrance should be kept open to minimize travel distances for people with disabilities.
- Elevators and Escalators** Elevators are essential to people using wheelchairs. Escalators are also necessary for those persons with stamina or respiratory problems. It is important that any required repairs be completed as quickly as possible.
- Elevators are currently being equipped with an alerting system which rings the fare collector and Central Control when the elevator breaks down. The "Elevator Update Line" should be updated as soon as possible and a speedy repair should be scheduled.
- Alarm systems and telephones inside elevators need to be inspected periodically for effectiveness.
- Telephones** Pay phones are installed by the New England Telephone Company and should comply with UFAS 4.31 and MAAB 37. The telephone company should be contacted immediately if an accessible telephone is out of order. Unobstructed clear space at all accessible telephones needs to be maintained.

- At least one phone per bank should be accessible
- The highest operable part is no higher than 54 inches
- Receiver equipped with inductive coil
- Volume control is provided
- Telephone books, if provided, are within reach of a person seated in a wheelchair
- The cord length from the telephone to the handset is at least 29 inches long
- TDD provided at each station

### Accessible Telephone Features

Several types of tactile and visual materials are used to warn people of the platform edge. Since these warning materials are critical to the safety of passengers, they should be well maintained at all times. The material should periodically be cleaned or repainted to preserve the contrasting color, and tactile edge treatment discernable underfoot should be inspected for signs of wear.

### Platform Edge

Once in place, visually impaired riders rely *heavily* upon tactile warning materials. If the material were to suddenly be removed, an extremely dangerous situation would be created.

**Therefore tactile materials should not be removed.** The material should be maintained at all times. If the material must be temporarily removed for repairs, consider working on small sections of the platform which can be repaired in one day.

Place a series of barriers at right angles to the platform edge. With such a barrier, passengers can still enter and exit the train, and visually impaired riders walking along the platform will be warned of a construction zone. Be careful to leave ample space for wheelchair maneuvering around the barriers.

A contrasting color should be maintained on step edges to alert people to the depth and height of stairs. Rubber flooring on stairs needs to be kept fastened to the back edge of the tread. Stair coverings can come loose and should be physically inspected.

### Stairs

Separating thresholds or loose rubber flooring can trip passengers and are especially dangerous for people using a walking aid. Re-anchor these materials as necessary.

### Floors

**Lighting** Many elderly people and people with visual impairments do not perceive much light with their eyes. For them, adequate levels of lighting may determine their ability to use the station. Where bulbs or fixtures are burnt out or dirty, they should be cleaned and replaced. Consider improving lighting at older stations. Care should be taken to maximize lighting level but minimize glare on signs, and to minimize changes in the lighting level as one walks through the station.

**Signs** Many passengers with visual impairments may need to read signs at a very close proximity. All signs need to have a clear space around and underneath them to allow passengers to view them up close. Trash barrels, newspaper vending machines, and benches should never be placed in front of signs. Signs should also be cleaned regularly to maintain clear contrast and readability.

**Seasonal Maintenance** New England's four seasons demand diligent maintenance techniques. Snow and ice create hazards for people with crutches or canes and for older people. Leaves that build up in catch basins in autumn cause flooding and puddles that inconvenience wheelchair users.

Following are some actions that can be taken:

- Remove the snow and ice along the accessible routes
- Watch for icy buildups which may indicate runoff problems
- Keep catch basins clear of leaves and debris

While ambulatory people can trudge over the snow, people using canes, walkers, or wheelchairs cannot. Accessible routes (curb cuts, ramps, walkways, and platforms) must be kept free from snow and ice. It is particularly important to keep overhead pedestrian track crossings free from ice and snow. Watch for areas with water or ice buildup which may indicate runoff or drainage problems.



Maintaining an accessible route is imperative in those stations which are designated accessible. If construction barriers are unavoidable, alternative accessible routes must be provided.

**Construction**

It is important for construction area barriers to be cane-detectable by visually impaired people. Barriers placed within 27 inches of the ground are cane-detectable. If sawhorses are used to designate construction areas, consider running plastic ribbon across the legs of the sawhorse within the cane-detectable zone.

Passengers with visual limitations or with poor balance are dependent on handrails to guide them on stairs and through the station. Keep handrails clean and also free of splinters and debris. Maintenance contractors should be alerted to this requirement since it may often be overlooked in the cleaning process. Caution should be used when cleaning around delicate electrical equipment, such as TDDs, to avoid shorting out the wiring.

**Cleaning**



# 6

## DESIGN REVIEW CHECKLIST

## How to Use the Checklist

This checklist is intended for use by station designers and MBTA project managers. It is recommended that the checklist be used at the 30%, 60% and 90% checkpoints. At the end of the design process, the completed checklist should be submitted to the MBTA project manager.

The checklist has two major sections: the Site and the Station. Within each section the questions are divided by element and drawing type (example: Indoor Ramp Plans).

The checklist questions are based on the Rules and Regulations of the Massachusetts Architectural Access Board (MAAB), the Uniform Federal Accessibility Standards (UFAS), and MBTA policy. Those items marked "MBTA" are additional requirements established by the MBTA. This checklist does not replace the codes in any way.

References to the appropriate UFAS, MAAB, or MBTA regulations are provided with each question. The reviewer can explore these references for additional information when necessary.

If all the questions can be answered "yes," the station should be accessible. Those questions which are checked "no" require further resolution. At the end of the design process, any code requirement which has not been met must be granted a variance from the code authorities before construction begins.

**Do not rely exclusively on the checklist. The main body of this guidebook discusses issues which cannot be reduced to yes or no questions.**

# Design Review Checklist

Yes	No		Reference		
			MAAB	UFAS	MBTA
<input type="checkbox"/>	<input type="checkbox"/>	<b>Parking Area Plan:</b> <i>Is parking currently provided or is it in the prospective plans? If yes, proceed with these parking requirements.</i>			
<input type="checkbox"/>	<input type="checkbox"/>	Are there enough accessible parking spaces?	23.4	4.1.1(5a)	
<input type="checkbox"/>	<input type="checkbox"/>	Are the accessible parking spaces closest to the accessible entrance (or the platform at commuter rail stations)?	23.2	4.6.2	
<input type="checkbox"/>	<input type="checkbox"/>	Are the accessible parking spaces within 200 ft. of the entrance? (option: drop-off within 100 ft. of the entrance)	23.2		
<input type="checkbox"/>	<input type="checkbox"/>	Is there an accessible path of travel without obstructions, steps, or other barriers from the parking area to the station entrance?	20.1	4.3.2(1)	
<input type="checkbox"/>	<input type="checkbox"/>	Are accessible parking spaces located along a safe pedestrian path of travel?			MBTA
<input type="checkbox"/>	<input type="checkbox"/>	Are walkways protected by bumpers or curbstops that prevent encroachment of cars into the walkways?			MBTA
<input type="checkbox"/>	<input type="checkbox"/>	Is each accessible parking space 13 ft. wide? Or, are there two 8 ft. wide spaces with a 5 ft. wide aisle between them?	23.5	4.6.3	
<input type="checkbox"/>	<input type="checkbox"/>	Is there a curb cut leading to a sidewalk at each accessible space or pair of spaces?	23.6		
<input type="checkbox"/>	<input type="checkbox"/>	At each accessible parking space, is there a sign posted between 5 ft and 8 ft from the ground with the universal symbol of accessibility?	23.7	4.6.4	
<input type="checkbox"/>	<input type="checkbox"/>	In addition to a sign on a post, is the universal symbol of accessibility painted on the ground in each parking space?			MBTA
		<b>Parking Area Section:</b>			
<input type="checkbox"/>	<input type="checkbox"/>	Is there at least 9 ft. 6 in. vertical clearance along the vehicle routes to accessible van parking spaces?		4.6.6	
<input type="checkbox"/>	<input type="checkbox"/>	Is there at least 9 ft. 6 in. vertical clearance at the accessible van parking spaces?		4.6.6	
		<b>Drop-Off Area Plan:</b>			
<input type="checkbox"/>	<input type="checkbox"/>	<i>Is a drop off area currently provided or in the prospective plans? If yes, proceed with the following questions.</i>			
<input type="checkbox"/>	<input type="checkbox"/>	If the drop-off area has curbs, is there a curb cut leading to a walkway?		4.6.5	
<input type="checkbox"/>	<input type="checkbox"/>	Is there an accessible path of travel without obstructions, steps or other barriers from the drop-off to the entrance (or platform at commuter rail)?		4.3.2(1)	
		<b>Drop-Off Area Section:</b>			
<input type="checkbox"/>	<input type="checkbox"/>	Is there at least 9 ft. 6 in. of vertical clearance provided at the drop-off area?		4.6.6	
<input type="checkbox"/>	<input type="checkbox"/>	Is there at least 9 ft. 6 in. of vertical clearance provided along vehicular access to the drop-off?		4.6.6	

# Design Review Checklist

Yes	No		Reference		
			MAAB	UFAS	MBTA
<input type="checkbox"/>	<input type="checkbox"/>	<b>Route of Travel Plan:</b>			
<input type="checkbox"/>	<input type="checkbox"/>	Are all walkways at least 48 in. wide?	22.1		
<input type="checkbox"/>	<input type="checkbox"/>	Is a passing space 60 in. by 60 in. available at least every 200 feet?		4.3.4	
<input type="checkbox"/>	<input type="checkbox"/>	If there are pedestrian bridges, underpasses, or overpasses, do they meet the criteria for walkways and ramps? (Check the overpass with the Route of Travel Details section of this checklist and the Exterior Ramps section if necessary.)	22.5		
<input type="checkbox"/>	<input type="checkbox"/>	If outdoors, has the option of overhead protection for ramps and pedestrian bridges been submitted for MBTA review?			MBTA
<input type="checkbox"/>	<input type="checkbox"/>	Are ramps located close to the main circulation route?			MBTA
<input type="checkbox"/>	<input type="checkbox"/>	Are there curb cuts on all corners at each intersection of roads and walkways?	21.1.1	4.7.1	
<input type="checkbox"/>	<input type="checkbox"/>	Are there two curb cuts at each corner, one located within each crosswalk?	21.1.1		
<input type="checkbox"/>	<input type="checkbox"/>	Does every curb cut have another curb cut on the opposite side of the street?	21.1.2		
<input type="checkbox"/>	<input type="checkbox"/>	If driveways intersecting sidewalks have side curbs, are there curb cuts provided?	21.1.3		
<input type="checkbox"/>	<input type="checkbox"/>	Do street islands have street level pathways cut through them?	21.3	4.7.11	
<input type="checkbox"/>	<input type="checkbox"/>	<b>Route of Travel Section:</b>			
<input type="checkbox"/>	<input type="checkbox"/>	Do all walkways have clear headroom of at least 80 in.?	26.6	4.4.2	
<input type="checkbox"/>	<input type="checkbox"/>	Are there permanent walls or barriers below free-standing staircases and escalators to prevent people from walking under the stairs?		4.4.2	
<input type="checkbox"/>	<input type="checkbox"/>	<b>Route of Travel Details:</b>			
<input type="checkbox"/>	<input type="checkbox"/>	Is the walkway surface either paved or hard-packed?		4.5.1	MBTA
<input type="checkbox"/>	<input type="checkbox"/>	Is the surface non-slip?	22.2	4.5.1	
<input type="checkbox"/>	<input type="checkbox"/>	Is the walkway made with a continuous surface with no abrupt changes in level greater than 1/2 in.?	22.2	4.3.8	
<input type="checkbox"/>	<input type="checkbox"/>	Where walkway materials change, is the vertical height between the two materials less than 1/2 in.?	22.2		
<input type="checkbox"/>	<input type="checkbox"/>	Where jointed surfaces are used (pavers, brick, etc.), is the underlying base firm, and are joints narrow and set to close tolerances?			MBTA
<input type="checkbox"/>	<input type="checkbox"/>	Are level changes between 1/4 in. and 1/2 in. beveled with a maximum slope of 1:2?		4.5.2	

# Design Review Checklist

Yes	No		Reference		
			MAAB	UFAS	MBTA
<input type="checkbox"/>	<input type="checkbox"/>	Is the site graded to avoid flow of water onto pathways and driveways?	20.4		
<input type="checkbox"/>	<input type="checkbox"/>	Is the area on either side of walkways firmly compacted so wheelchairs will not sink in?			MBTA
<input type="checkbox"/>	<input type="checkbox"/>	Are the walkway edges flush with adjoining surfaces?			MBTA
<input type="checkbox"/>	<input type="checkbox"/>	Are catch basins and utility covers located out of the path of travel?			MBTA
<input type="checkbox"/>	<input type="checkbox"/>	Are catch basins located away from the curb cuts, so that the curb cuts are not flooded in wet weather?			MBTA
<input type="checkbox"/>	<input type="checkbox"/>	Are openings in gratings no more than 1/2 in. wide, and is the long dimension faced perpendicular to the usual direction of travel?	26.5	4.5.4	
<input type="checkbox"/>	<input type="checkbox"/>	Are exterior drinking fountains and public telephones located where they do not impede the path of travel?	26.6	4.4.1	MBTA
<input type="checkbox"/>	<input type="checkbox"/>	Are all walkways and steps well lit for night use?			MBTA
<b>Curb Cut Details:</b>					
<input type="checkbox"/>	<input type="checkbox"/>	Is the slope of curb cuts 1:12 or less?	21.1.4	4.7.2	
<input type="checkbox"/>	<input type="checkbox"/>	Is the maximum slope of any surface adjoining the curb cut such as a gutter, parking lot, or sidewalk, 1:20 or less?		4.7.2	
<input type="checkbox"/>	<input type="checkbox"/>	Is the curb cut at least 36 in. wide, not including the flared sides?	21.1.5		
<input type="checkbox"/>	<input type="checkbox"/>	Does the curb cut have flared sides?	21.1.6		
<input type="checkbox"/>	<input type="checkbox"/>	Do the flared sides extend at least 24 in. at the curb edge?	21.1.6		
<input type="checkbox"/>	<input type="checkbox"/>	If possible, is there a 48 in. wide level section of pavement at the top and bottom of each curb cut?			MBTA
<input type="checkbox"/>	<input type="checkbox"/>	Is the curb height at each intersection less than 7 in.?	21.1.7		
<input type="checkbox"/>	<input type="checkbox"/>	Is the surface a non-slip material?		4.5.1	
<input type="checkbox"/>	<input type="checkbox"/>	Is the texture roughened in the direction of the slope or is the curb cut painted yellow?	21.1.8		
<input type="checkbox"/>	<input type="checkbox"/>	Does the slope of the curb cut blend (less than 1/2 in. lip) to meet the street?	21.1.4		
<b>Grading:</b>					
<input type="checkbox"/>	<input type="checkbox"/>	Is the slope of sidewalks, walkways, and parking areas not more than 1:20 (5%)?	22.1	4.3.7	

# Design Review Checklist

Yes	No		MAAB	Reference UFAS	MBTA
<input type="checkbox"/>	<input type="checkbox"/>	Is the cross slope of the sidewalk less than 2%?		4.3.7	
<input type="checkbox"/>	<input type="checkbox"/>	<b>Outdoor Ramp Plan:</b> Are ramps straight, not curved?	25.7		
<input type="checkbox"/>	<input type="checkbox"/>	Is the slope of the ramp 1:12.5 or less?			MBTA
<input type="checkbox"/>	<input type="checkbox"/>	Is there a level platform located within every 30 in. of rise or within every 30 ft. of ramp?		4.8.2	MBTA
<input type="checkbox"/>	<input type="checkbox"/>	Are the level platforms at least 60 in. wide by 60 in. long where ramps change direction?	25.6	4.8.4	
<input type="checkbox"/>	<input type="checkbox"/>	Are there 60 in. long level platforms at the top and bottom of the ramp?	25.6	4.8.4	
<input type="checkbox"/>	<input type="checkbox"/>	Are the level platforms as wide as the ramp (at least 48 in.) and 60 in. long where no change of direction occurs?	25.6	4.8.4	
<input type="checkbox"/>	<input type="checkbox"/>	Do ramps have handrails on both sides?	25.4	4.8.5	
<input type="checkbox"/>	<input type="checkbox"/>	Is the ramp at least 48 in. wide, measured between the handrails?	25.3		
<input type="checkbox"/>	<input type="checkbox"/>	Is there a 12 in. horizontal extension of the handrail at the top landing and at the bottom landing?	25.4	4.8.5(2)	
<input type="checkbox"/>	<input type="checkbox"/>	Are handrails continuous at landings, except where they would be an obstruction?			MBTA
<input type="checkbox"/>	<input type="checkbox"/>	Is there a space of 1-1/2 in. between the handrail and the wall?	25.4		
<input type="checkbox"/>	<input type="checkbox"/>	Is the ramp surface non-slip?	25.4	4.5.1	
<input type="checkbox"/>	<input type="checkbox"/>	Are ramps and their approaches designed so that water will not accumulate on walking surfaces?		4.8.8	
<input type="checkbox"/>	<input type="checkbox"/>	<b>Outdoor Ramp Section:</b> Do ramps have at least 80 in. headroom?	26.6	4.4.2	
<input type="checkbox"/>	<input type="checkbox"/>	Are there two handrails, one at 34 in., the other at 19 in. above the surface of the ramp?	25.4		
<input type="checkbox"/>	<input type="checkbox"/>	Are the handgrips either round or oval in cross-section?	25.4		
<input type="checkbox"/>	<input type="checkbox"/>	Is the handgrip diameter between 1-1/4 in. and 1-1/2 in.?		4.26.2	
<input type="checkbox"/>	<input type="checkbox"/>	<b>Outdoor Stairs Plan:</b> Are there permanent walls or barriers below free-standing staircases to prevent people from walking under them?		4.4.2	
<input type="checkbox"/>	<input type="checkbox"/>	Do steps have handrails on both sides?	28.3	4.9.4	

# Design Review Checklist

Yes	No		Reference		MAAB	UFAS	MBTA
<input type="checkbox"/>	<input type="checkbox"/>	Are wall handrails continuous at landings, except where they would be an obstruction?					MBTA
<input type="checkbox"/>	<input type="checkbox"/>	Do the handrails extend 12 in. horizontally beyond the last riser at the top and bottom steps?	28.3	4.9.4			
<input type="checkbox"/>	<input type="checkbox"/>	Do stair nosings contrast in color value from the treads, or does the stair stringer color contrast with tread and riser color?					MBTA
<b>Outdoor Stairs Section:</b>							
<input type="checkbox"/>	<input type="checkbox"/>	Are the handrails mounted 34 in. above the intersection of the tread and riser?	28.3				
<input type="checkbox"/>	<input type="checkbox"/>	Is a second handrail provided on stairs at 19 in.?					MBTA
<input type="checkbox"/>	<input type="checkbox"/>	Are handrail gripping surfaces uninterrupted by newel posts, wall brackets or supports, construction elements or other obstructions?		4.9.4			
<input type="checkbox"/>	<input type="checkbox"/>	Are the handrail ends rounded or returned smoothly to the wall, floor or post?		4.9.4			
<input type="checkbox"/>	<input type="checkbox"/>	Is there a space of 1-1/2 in. between the handrail and the wall?	28.5	4.26.2			
<input type="checkbox"/>	<input type="checkbox"/>	Are the handrails either round or oval in cross-section?	28.4				
<input type="checkbox"/>	<input type="checkbox"/>	Do stairs have closed risers?	28.2	4.9.2			
<input type="checkbox"/>	<input type="checkbox"/>	Are stairs free of nosing projections?	28.2	4.9.3			
<input type="checkbox"/>	<input type="checkbox"/>	Are stair treads at least 11 in. wide?		4.9.2			
<input type="checkbox"/>	<input type="checkbox"/>	Is the intersection of the tread and the riser 70 degrees or less?	28.2				
<b>Entrance Plan:</b>							
<input type="checkbox"/>	<input type="checkbox"/>	Is each primary entrance accessible?	26.1				
<input type="checkbox"/>	<input type="checkbox"/>	Is the approach to the entrance a paved ramp or walkway, with a non-slip surface?	26.2	4.3.2			
<input type="checkbox"/>	<input type="checkbox"/>	Is the approach to the accessible entrance free of barriers such as steps or stairs?	26.2	4.3.2			
<input type="checkbox"/>	<input type="checkbox"/>	Is there an accessible pathway from each primary entrance to the elevators?	26.4	4.3.2			
<input type="checkbox"/>	<input type="checkbox"/>	Is overhead protection or a snow-melting device provided at the headhouse entrance?	18.2				
<input type="checkbox"/>	<input type="checkbox"/>	Is there a 60 in. by 60 in. level space inside and outside the entry door?	26.2				
<input type="checkbox"/>	<input type="checkbox"/>	If there is an inaccessible revolving door, is there an adjacent, accessible door?	27.10	4.13.2			



# Design Review Checklist

Yes	No		Reference		
			MAAB	UFAS	MBTA
<input type="checkbox"/>	<input type="checkbox"/>	Are the doors at the accessible entrance at least 36 in. wide, with 34 in. minimum clear opening?	27.3		
<input type="checkbox"/>	<input type="checkbox"/>	If there are any pivot doors, can they be opened 34 in. clear?	27.2		
<input type="checkbox"/>	<input type="checkbox"/>	In entry vestibules, is there at least 48 in., clear of door swings, between the sets of doors ?	26.3	4.13.7	
<input type="checkbox"/>	<input type="checkbox"/>	Are directions to the accessible entrance posted at each inaccessible entrance?	26.7		
<input type="checkbox"/>	<input type="checkbox"/>	Is there at least 18 in. beside the latch on the pull side of every door in the building?	27.4	4.13.6	
<b>Entrance Details:</b>					
<input type="checkbox"/>	<input type="checkbox"/>	Are entrance thresholds no higher than 1/2"?	27.7	4.13.8	
<input type="checkbox"/>	<input type="checkbox"/>	Are thresholds beveled with a slope no greater than 1:2?		4.13.8	
<input type="checkbox"/>	<input type="checkbox"/>	Are the interior doorways free of thresholds?	27.7		
<input type="checkbox"/>	<input type="checkbox"/>	Is hardware on all doors operable with one hand?	27.11	4.13.9	
<input type="checkbox"/>	<input type="checkbox"/>	Are glass doors distinguishable from adjacent floor to ceiling windows?			MBTA
<b>Circulation:</b>					
<input type="checkbox"/>	<input type="checkbox"/>	Are all changes in floor elevations accommodated by ramps, lifts, or elevators?	35.1	4.3.8	
<input type="checkbox"/>	<input type="checkbox"/>	Are corridors at least 36 in. wide?	5.12	4.3.3	
<input type="checkbox"/>	<input type="checkbox"/>	Are there 60 in. wide passing areas within every 200 ft.?		4.3.4	
<b>Drinking Fountains:</b>					
<input type="checkbox"/>	<input type="checkbox"/>	At every drinking fountain location, is at least one drinking fountain accessible to wheelchair users? (Basin rim 34 in. above the floor, hand-operated push-button or lever, stream of water as parallel to the front of the basin as possible.)	36.1	4.15	
<input type="checkbox"/>	<input type="checkbox"/>	Are wall mounted drinking fountains located so that they do not protrude more than 4 inches into the path of travel or do they have wing walls or sides which extend to within 27 in. of finished floor?		4.4.1	
<input type="checkbox"/>	<input type="checkbox"/>	For recessed installations, is the recess at least 30 in. wide and no deeper than the depth of the fountain?	36.2		
<input type="checkbox"/>	<input type="checkbox"/>	For floor mounted installations, is there a clear floor space of at least 30 in. by 48 in. in front of the fountain?	36.3	4.15.5	
<b>Public Telephones:</b>					
<input type="checkbox"/>	<input type="checkbox"/>	Wherever public telephones are provided, is at least one telephone accessible?	37.1		

# Design Review Checklist

Yes	No		Reference		
			MAAB	UFAS	MBTA
<input type="checkbox"/>	<input type="checkbox"/>	Are public telephones located in quiet areas to make hearing easier?			MBTA
<input type="checkbox"/>	<input type="checkbox"/>	Is volume control provided on the accessible phone?	37.5		
<input type="checkbox"/>	<input type="checkbox"/>	Do telephones have a receiver which generates a magnetic field in the receiver cap?		4.31.5	
<input type="checkbox"/>	<input type="checkbox"/>	Are wall mounted telephones located so that they do not protrude more than 4 in. into a path of travel or do they have wing walls which extend to within 27 in. of finished floor?		4.4.1	
<input type="checkbox"/>	<input type="checkbox"/>	Is the coin slot on the accessible public telephone no more than 54 in. above the floor, where clear space is 30 in. x 48 in. alongside the phone?	37.2	4.31.3/4.2.6	
<input type="checkbox"/>	<input type="checkbox"/>	Where a forward reach is required on the accessible phone, is the coin slot less than 48 in. above the floor, where clear space is 48 in. x 30 in. facing the phone?		4.31.3/4.2.5	
<b>Indoor Stairs Plan:</b>					
<input type="checkbox"/>	<input type="checkbox"/>	Are there permanent walls or barriers below free-standing staircases and escalators to prevent people from walking under the stairs?		4.4.2	
<input type="checkbox"/>	<input type="checkbox"/>	Are there handrails on both sides of the stairs?	28.3	4.9.4	
<input type="checkbox"/>	<input type="checkbox"/>	Are wall handrails continuous at landings, except where they would be an obstruction?			MBTA
<input type="checkbox"/>	<input type="checkbox"/>	At the top and bottom of the stairs, do wall handrails continue to slope beyond the last riser, and is there 12 inches of horizontal handrail beyond that?	28.3	4.9.4	
<b>Indoor Stairs Section:</b>					
<input type="checkbox"/>	<input type="checkbox"/>	Are the handrails mounted 34 in. above the intersection of the tread and riser?	28.3		
<input type="checkbox"/>	<input type="checkbox"/>	Is a second handrail mounted at 19 in.?			MBTA
<input type="checkbox"/>	<input type="checkbox"/>	Are handrail gripping surfaces uninterrupted by newel posts, construction elements of other obstructions?		4.9.4	
<input type="checkbox"/>	<input type="checkbox"/>	Are the handrail ends rounded or returned smoothly to the wall, floor or post?		4.9.4	
<input type="checkbox"/>	<input type="checkbox"/>	Is there a space of 1-1/2 in. between the handrail and the wall?	28.5		
<input type="checkbox"/>	<input type="checkbox"/>	Are the handrails either round or oval in cross-section?	28.4		
<input type="checkbox"/>	<input type="checkbox"/>	Do stairs have a closed riser?	28.2	4.9.2	
<input type="checkbox"/>	<input type="checkbox"/>	Are stairs free of nosing projections?	28.2	4.9.3	
<input type="checkbox"/>	<input type="checkbox"/>	Are stair treads at least 11 in. wide?		4.9.2	
<input type="checkbox"/>	<input type="checkbox"/>	Is the intersection of the tread and the riser 70 degrees or less?	28.2		

Yes	No		Reference		
			MAAB	UFAS	MBTA
<input type="checkbox"/>	<input type="checkbox"/>	<b>Indoor Ramp Plan:</b> Are ramps straight, not curved?	25.7		
<input type="checkbox"/>	<input type="checkbox"/>	Is the slope of the ramp 1:12.5 or less?			MBTA
<input type="checkbox"/>	<input type="checkbox"/>	Is there a level platform located within every 30 in. of rise or within every 30 ft. of ramp?		4.8.2	MBTA
<input type="checkbox"/>	<input type="checkbox"/>	Are the level platforms at least 60 in. wide by 60 in. long where ramps change direction?	25.6	4.8.4	
<input type="checkbox"/>	<input type="checkbox"/>	Are there 60 in. long level platforms at the top and bottom of the ramp?	25.6	4.8.4	
<input type="checkbox"/>	<input type="checkbox"/>	Are the level platforms as wide as the ramp (at least 48 in.) and 60 in. long where no change of direction occurs?	25.6	4.8.4	
<input type="checkbox"/>	<input type="checkbox"/>	Does the ramp have handrails on both sides?	25.4	4.8.5	
<input type="checkbox"/>	<input type="checkbox"/>	Is the ramp at least 48 in. wide, measured between the handrails?	25.3	4.8.3	
<input type="checkbox"/>	<input type="checkbox"/>	Is there a 12 in. horizontal extension of the handrail at the top landing and at the bottom landing?	25.4	4.8.5(2)	
<input type="checkbox"/>	<input type="checkbox"/>	Are handrails continuous at landings, except where they would be an obstruction?			MBTA
<input type="checkbox"/>	<input type="checkbox"/>	Is there a space of 1-1/2 in. between the handrail and the wall?	25.4		
<input type="checkbox"/>	<input type="checkbox"/>	Is the ramp surface non-slip?	21.1.4	4.5.1	
<input type="checkbox"/>	<input type="checkbox"/>	Is each platform free from obstructions from door swings or other projections?	25.6		
<input type="checkbox"/>	<input type="checkbox"/>	<b>Indoor Ramp Section:</b> Do ramps have at least 80 inches headroom?		4.4.2	
<input type="checkbox"/>	<input type="checkbox"/>	Are there two handrails, one at 34 in. and the other at 19 in. above the surface of the ramp?	25.4	4.8.5	
<input type="checkbox"/>	<input type="checkbox"/>	Are the handgrips either round or oval in cross-section?	25.4		
<input type="checkbox"/>	<input type="checkbox"/>	Is the handgrip diameter between 1-1/4 in. and 1-1/2 in.?	25.4		
<input type="checkbox"/>	<input type="checkbox"/>	<b>Elevators:</b> Is the highest hallway call button centered no more than 42 in. above the floor?	35.7	4.10.3	
<input type="checkbox"/>	<input type="checkbox"/>	Are the call buttons at least 3/4 inches in the smallest dimension?		4.10.3	
<input type="checkbox"/>	<input type="checkbox"/>	Do the hall call buttons have visual signals to indicate when each call is registered and answered?		4.10.3	

# Design Review Checklist

Yes	No		Reference		
			MAAB	UFAS	MBTA
<input type="checkbox"/>	<input type="checkbox"/>	Is the button designating the up direction on top?		4.10.3	
<input type="checkbox"/>	<input type="checkbox"/>	Are the buttons raised or flush with the wall?		4.10.3	
<input type="checkbox"/>	<input type="checkbox"/>	Is there no obstacle placed directly below or above the call buttons?	35.7		
<input type="checkbox"/>	<input type="checkbox"/>	Is there a visible and audible signal at each hoistway entrance to indicate which car is answering a call?		4.10.4	
<input type="checkbox"/>	<input type="checkbox"/>	Do audible signals sound once for up and twice for down, or do they have verbal annunciators that say "up" or "down"?	35.8	4.10.4	
<input type="checkbox"/>	<input type="checkbox"/>	Are the visual signals: mounted at least 72 inches above the floor? at least 2 1/2 inches in the smallest dimension? visible from the vicinity of the hall call button?		4.10.4	
<b>FOR EXISTING ELEVATORS</b>					
<b>Door Jamb and Threshold:</b>					
<input type="checkbox"/>	<input type="checkbox"/>	Does the floor of the elevator car come within 1/2 inch of the hallway floor at each stop?		4.10.2	
<input type="checkbox"/>	<input type="checkbox"/>	Is the horizontal gap between the car floor platform and the landing sill no greater than 1-1/4 inch?		4.10.9	
<b>Doors:</b>					
<input type="checkbox"/>	<input type="checkbox"/>	Do the elevators doors open and close automatically? Do they re-open automatically if they become obstructed?	35.3.2	4.10.6	
<input type="checkbox"/>	<input type="checkbox"/>	Do the elevators doors remain fully open for a minimum of 3 seconds?		4.10.8	
<input type="checkbox"/>	<input type="checkbox"/>	Do the doors provide at least a 36 in. clear opening? (In a retrofit situation, 32 in. clear opening is acceptable.)	35.3	4.10.9	
<b>Elevator Cab:</b>					
<input type="checkbox"/>	<input type="checkbox"/>	In a new station, is the interior cab size either at least 54 x 80 inches wall-to-wall?		Elevator Board 17.4.0	
<input type="checkbox"/>	<input type="checkbox"/>	In a retrofitted station, is the interior cab size: at least 51 x 80 inch wall-to-wall with a centered door?		4.10.9 (a)	
<input type="checkbox"/>	<input type="checkbox"/>	at least 51 x 68 inch with an off-centered door?		4.10.9 (b)	
<input type="checkbox"/>	<input type="checkbox"/>	as close to those dimensions as possible, but not less than 54 x 54 inches?		35.4	
<input type="checkbox"/>	<input type="checkbox"/>	Are the floors in and around the elevator stable, firm, and slip-resistant?	35.11	4.5.1	
<b>Elevator Control Panels:</b>					
<input type="checkbox"/>	<input type="checkbox"/>	If the cars have central opening doors are the controls located on the front wall?		4.10.12	

# Design Review Checklist

Yes	No		Reference		
			MAAB	UFAS	MBTA
<input type="checkbox"/>	<input type="checkbox"/>	If the cars have side opening doors are the controls located on the side or front wall adjacent to the doors?		4.10.12	
<input type="checkbox"/>	<input type="checkbox"/>	If the elevator has two doors, is a control panel provided at each?			MBTA
<input type="checkbox"/>	<input type="checkbox"/>	Are the controls no higher than 48 in.? (If there is a substantial increase in cost, 54 in. is acceptable.)		4.10.12	
<input type="checkbox"/>	<input type="checkbox"/>	Are the controls no lower than 35 in. above the floor measure from the centerline of the buttons?	35.5	4.10.12	
<input type="checkbox"/>	<input type="checkbox"/>	Are the emergency buttons grouped at the bottom of the panel with centerlines no less than 35 in. above the floor?	35.5	4.10.12	
<input type="checkbox"/>	<input type="checkbox"/>	Is there a visual car position indicator above the car control panel or over the door and an audio signal to indicate the passing floor level?	35.6	4.10.13	
<input type="checkbox"/>	<input type="checkbox"/>	Is the highest operable part of an emergency two-way communication system no more than 48 in.?		4.10.14	
<input type="checkbox"/>	<input type="checkbox"/>	If the system uses a handset, then the length of the cord from the panel to the handset at least 29 in.?		4.10.14	
<input type="checkbox"/>	<input type="checkbox"/>	If the system is in a closed compartment, is the hardware on the compartment door operable with one hand, and does its operation not require tight grasping, pinching, or twisting of the wrist?		4.10.14	
<input type="checkbox"/>	<input type="checkbox"/>	Is the emergency intercommunication usable without voice communication?		4.10.14	
		<b>Platforms:</b>			
<input type="checkbox"/>	<input type="checkbox"/>	Is the platform free of obstructions for a distance of 5 ft. from the platform edge?			MBTA
<input type="checkbox"/>	<input type="checkbox"/>	Is the platform clear space at least 60 in. at points where it is necessary to make a turn?		4.34	
<input type="checkbox"/>	<input type="checkbox"/>	Is there a minimum of 36 in. clear width between platform elements such as walls and columns?		4.3.3	
<input type="checkbox"/>	<input type="checkbox"/>	Is the platform surface a non-slip material?	22.3	4.3	
<input type="checkbox"/>	<input type="checkbox"/>	Is the horizontal gap between the platform edge and the car less than 4 in.?	18.3.1		
<input type="checkbox"/>	<input type="checkbox"/>	Is the vertical gap between the platform edge and the car less than 2 in.?	18.3.1		
<input type="checkbox"/>	<input type="checkbox"/>	Is the slope of the platform parallel to the tracks 5% or less?	22.1	4.3.7	
<input type="checkbox"/>	<input type="checkbox"/>	Is the cross slope perpendicular to the tracks 2% or less?		4.3.7	
<input type="checkbox"/>	<input type="checkbox"/>	Is there a tactile warning strip on the platform edge, at least 24 in. wide which is detectable by stepping upon it?			MBTA
<input type="checkbox"/>	<input type="checkbox"/>	Are there seats provided every 250 ft. or less?	18.3.3		

# Design Review Checklist

Yes	No		Reference		
			MAAB	UFAS	MBTA
<input type="checkbox"/>	<input type="checkbox"/>	Where benches are provided, is there 36 in. adjacent to the bench for a wheelchair to pull up?			MBTA
<b>Additional Requirements for Commuter Rail:</b>					
<input type="checkbox"/>	<input type="checkbox"/>	Does an unobstructed continuous path of travel connect all terminal buildings, station houses, platforms, accessible parking space areas, and street entrances?	MAAB (new)		
<input type="checkbox"/>	<input type="checkbox"/>	Do track crossings (at, above, or below grade) meet the Route of Travel requirements and ramp and stair requirements if they apply?	MAAB	UFAS	
<input type="checkbox"/>	<input type="checkbox"/>	Are full-length raised platforms provided at newly constructed stations or stations which are being re-opened after being out of operation for 5 years or more?	MAAB (new)		
<input type="checkbox"/>	<input type="checkbox"/>	Are access platforms provided at any reconstructed, altered or remodeled stations?	MAAB (new)		
<input type="checkbox"/>	<input type="checkbox"/>	Is overhead shelter provided for 150 ft. of the low level platform?	MAAB (new)		
<input type="checkbox"/>	<input type="checkbox"/>	Is the access platform at least 45 ft. long and 5 ft wide?	MAAB (new)		
<input type="checkbox"/>	<input type="checkbox"/>	Is the access platform surface 48 in. above the top of the rails?			MBTA
<input type="checkbox"/>	<input type="checkbox"/>	Is overhead shelter provided for the entire access platform and its ramp?	MAAB (new)		
<input type="checkbox"/>	<input type="checkbox"/>	Do all platforms have a yellow tactile edge treatment detectable underfoot and at least 24 inches wide?	MAAB (new)		
<input type="checkbox"/>	<input type="checkbox"/>	Where the gap between the coach and the platform exceeds 4 in. in the horizontal plane or 2 inches in the vertical plane, is a bridged plate used?	MAAB (new)		
<input type="checkbox"/>	<input type="checkbox"/>	Is seating provided at intervals not exceeding 250 ft.?	MAAB (new)		
<b>Public and Employee Toilet Rooms:</b>					
<input type="checkbox"/>	<input type="checkbox"/>	Are the toilet rooms located on a route which is accessible to people in wheelchairs?			4.22.1
<input type="checkbox"/>	<input type="checkbox"/>	Is there at least 18 in. beside the latch on the pull side of the door(s) to the bathroom?	27.4	4.13.6	
<input type="checkbox"/>	<input type="checkbox"/>	Does the vestibule have at least 48 in. between the swing of one door and the face of the other?	26.3	4.13.7	
<input type="checkbox"/>	<input type="checkbox"/>	Is there at least a 60 in. clear turning space in the bathroom?	30.3	4.13.3	
<input type="checkbox"/>	<input type="checkbox"/>	In each toilet room, is at least one water closet and one lavatory accessible?	30.1	4.22.4	
<input type="checkbox"/>	<input type="checkbox"/>	Does the accessible stall door either swing out of the stall or slide?	30.5.2		
<input type="checkbox"/>	<input type="checkbox"/>	Is the accessible stall door at least 36 in. wide?	30.5.2		
<input type="checkbox"/>	<input type="checkbox"/>	Is there at least 18 in. beside the latch on the pull side of the accessible stall door?	30.5.2	4.13.6	

# Design Review Checklist

Yes	No		Reference		
			MAAB	UFAS	MBTA
<input type="checkbox"/>	<input type="checkbox"/>	In the accessible stall, is there 18 in. from the centerline of the toilet to the nearest side wall?	30.5.3		
<input type="checkbox"/>	<input type="checkbox"/>	Is there at least 42 in. from the centerline of the toilet to the far side wall?	30.5.3		
<input type="checkbox"/>	<input type="checkbox"/>	Is the seat of the accessible toilet 17 in. to 19 in. above the floor?	30.5.3		
<input type="checkbox"/>	<input type="checkbox"/>	Are there 2 grab bars 42 in. long, one on the wall in back of the water closet and one on the side wall closest to the water closet?	30.5.4		
<input type="checkbox"/>	<input type="checkbox"/>	Are the ends of the grab bars 6 in. away from the corner of the wall?	30.5.4		
<input type="checkbox"/>	<input type="checkbox"/>	Are the grab bars 1-1/4 in. in outside diameter?	30.5.4		
<input type="checkbox"/>	<input type="checkbox"/>	Is there 1-1/2 in. clearance between the bar and the wall?	30.5.4		
<input type="checkbox"/>	<input type="checkbox"/>	Are the grab bars 30 in. above and parallel to the floor?	30.5.4		
<input type="checkbox"/>	<input type="checkbox"/>	Are the grab bars acid-etched or roughened?	30.5.4		
<input type="checkbox"/>	<input type="checkbox"/>	Is the toilet paper dispenser located on the side wall closest to the toilet?	30.9		
<input type="checkbox"/>	<input type="checkbox"/>	Is the toilet paper dispenser 24 in. above the floor?	30.9		
<input type="checkbox"/>	<input type="checkbox"/>	Does at least one sink have hardware operable with a closed fist?	30.4	4.27.4	
<input type="checkbox"/>	<input type="checkbox"/>	Is the top edge of the accessible sink 32 in. above the floor?	30.4		
<input type="checkbox"/>	<input type="checkbox"/>	Are all sinks mounted at the same height?			MBTA
<input type="checkbox"/>	<input type="checkbox"/>	Is there a knee space beneath the accessible sink at least 22 in. deep, 30 in. wide, and 29 in. high measured from the floor to the bottom of the apron?	30.4	4.19.2	
<input type="checkbox"/>	<input type="checkbox"/>	<b>Locker Rooms:</b> Are the aisles at least 36 in. wide?		4.3.3	
<input type="checkbox"/>	<input type="checkbox"/>	Is there at least 60 in. between banks of lockers, or if benches are provided, 42 in. between benches and accessible lockers?			MBTA
<input type="checkbox"/>	<input type="checkbox"/>	Is there at least 42 in. of unobstructed aisle space in front of the lockers used by handicapped people?			MBTA
<input type="checkbox"/>	<input type="checkbox"/>	Is there a 60 in. diameter turning space at accessible lockers?			MBTA
<input type="checkbox"/>	<input type="checkbox"/>	In locker rooms, is one bench provided against a wall, with a seat 24 in. wide and 60 in. long?			MBTA
<input type="checkbox"/>	<input type="checkbox"/>	Is one shower accessible in all gang showers, or is a private accessible shower room provided?			MBTA

# Design Review Checklist

Yes	No		MAAB	Reference UFAS	MBTA
		<b>Vendors:</b>			
<input type="checkbox"/>	<input type="checkbox"/>	Do vendor specifications require at least one counter, or a 30 in. long portion of one counter to be between 28 in. and 34 in. a.f.f. (preferably 32 in.)?		7.2	
		<b>Cafeterias and Restaurants:</b>			
<input type="checkbox"/>	<input type="checkbox"/>	Are aisles in the serving line at least 36 in. wide (preferably 42 in.)?	17.4.1		
<input type="checkbox"/>	<input type="checkbox"/>	Is the tray slide continuous from the tray stack all the way to the cashier?			MBTA
<input type="checkbox"/>	<input type="checkbox"/>	Is the tray slide no more than 34 in. above the floor?		5.2	
<input type="checkbox"/>	<input type="checkbox"/>	Is there at least a 36 in. aisle between tables?	17.3	4.3.3	
<input type="checkbox"/>	<input type="checkbox"/>	Are movable chairs and tables provided in addition to fixed seating?			MBTA
<input type="checkbox"/>	<input type="checkbox"/>	If seating is fixed, are at least 5% of all seating or tables accessible?	17.6	5.1	
		<b>Personnel/Employment Offices:</b>			
<input type="checkbox"/>	<input type="checkbox"/>	Do employee areas—except for mechanical rooms—comply with UFAS standards?		4.1.4	
<input type="checkbox"/>	<input type="checkbox"/>	Do employee bathrooms meet UFAS and MAAB standards for accessible toilet rooms?		4.1.4	



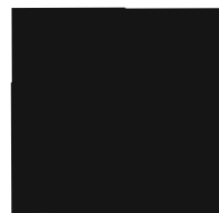

# APPENDIX



## Appendix A: Glossary

**Access gate:** The gate provided adjacent to turnstiles. It is used by people who cannot pass through turnstiles such as people using wheelchairs, walking aids, or strollers.

**Access platform:** A raised platform which is level with the train car floor. Access platforms extend for a partial length of the train and are usually about 45 feet long providing access to two cars of the train. A ramp and stairs provide vertical circulation up to the access platform. Access platforms are used by people who cannot board the train from the low level platform, or who prefer not to. (*See definition below.*)

**Accessible:** Describes programs and physical spaces which can be safely approached, entered, and used by people with disabilities.

**Accessible route:** A continuous, unobstructed path connecting all accessible elements and spaces within or between buildings, facilities or walks, that can be travelled by a disabled person using a wheelchair, and which is also safe and usable by people with other disabilities.

**Assistive Listening System:** Designed for people who are hard of hearing. There are a variety of systems which will allow people to hear sound in a noisy situation. The system can be used indoors or out of doors and may use infrared, FM or audio loop equipment to bring sound directly to the individual.

**ATBCB, Architectural and Transportation Barriers Compliance Board:** A federal board that establishes and enforces minimum guidelines for accessibility for all facilities constructed, leased, or financed by the federal government. It also provides technical assistance.

**Barrier-free:** Describes a structure without physical impediments to individuals with disabilities.

**Busway:** An off-street passenger loading zone for MBTA buses.

**City end:** The end of a commuter rail platform which is closest to Boston.

**Country end:** The end of a commuter rail platform which is furthest from Boston.

**Cross slope:** The slope across a pathway or outdoor travel surface, generally perpendicular to the usual direction of travel.

**Disabled:** See Physically disabled.

**Disability:** A physical condition that substantially limits one or more major life activities. (*See Physically disabled.*)

**Full-length raised platform:** A platform which is level with the floor of the train car for the full length of the platform.

**Headhouse:** The roofed structure above grade which houses the entrance to a subway station.

**Hearing impairment:** A partial or total loss of hearing. The means and methods of communication vary between individuals. Some hearing impaired people compensate with hearing aids and use spoken English. Some deaf people communicate in American Sign Language (ASL) and consider English primarily a written language. Others use signed English or lip-read.

**HP:** An abbreviation for Handicapped Person, often used on signs to identify an accessible element.

**International Symbol of Accessibility:** A pictograph of a person in a wheelchair used on signs to indicate accessible building elements, such as entrances and bathrooms.

**Level landing:** A ramp landing with no more than a 1:50 slope for drainage.

**Low level platform:** A platform which is below the level of the train car floor. It is usually about 8 inches above the top of the rails. Passengers use stairs to board the train.

**MAAB, Massachusetts Architectural Access Board:** The nine person board established under state law, M.G.L. Chapter 22, Section 13A. It enforces regulations governing building accessibility, reviews complaints and requests for waivers, and provides training and technical assistance on accessibility issues. This board was previously known as the Architectural Barriers Board and was amended by legislation Chapter 642 of the Acts of 1986 which became effective July 10, 1987.

**Mobility impaired:** People who cannot walk or walk with difficulty, who must walk slowly or who cannot walk long distances. Mobility impairments can be caused by a gait problem, lack of balance or stamina, cardiac or respiratory conditions, artificial legs, braces, canes, walkers, special shoes, etc.

**Non-slip:** A condition in which a rubber heel, cane tip, or crutch tip will not slip when pressure is applied at an angle on a level, wet surface.

**Physically disabled:** Describes a person who has a physical condition that substantially limits one or more major life activities, including but not limited to performing daily tasks, walking, seeing, hearing, speaking, breathing, and learning. Physically handicapped persons also include persons who lack coordination or stamina, people who are unable to reach and manipulate objects, or unable to interpret and react to sensory information, and people who are extreme in physical size.

**Tactile warning material:** A bright yellow textured material which is discernable underfoot from the floor materials adjacent to it. Protrusions at least 3/8 of an inch high are generally accepted as "discernable underfoot."

**TDD, Telecommunication Device for the Deaf:** A device for telephone service which sends and receives typed messages through a small display screen and a keyboard. It is used with a standard telephone, by placing the receiver onto the base of the TDD and typing messages. Some models include a paper printout.

**TTY, Teletypewriter:** Similar to a TDD. The term TTY is still preferred by many hearing impaired individuals.

**UFAS, Uniform Federal Accessibility Standards:** A set of standards adopted by the four federal standard-setting agencies to ensure uniformity between federal agency requirements for accessibility in buildings constructed, leased, or financed by the federal government. It covers new construction and alterations. The format and technical provisions of UFAS are modeled on ANSI A117 and there is an ongoing process to conform both standards.

**Visual impairment:** Some loss of vision ranging from moderate distortions or reduction in visual field to total blindness. In the Boston area 97% of visually impaired people have some vision. Some may not be able to read print, even with glasses; others may have a reduced visual field. Ability to perceive colors may be reduced, and “normal” illumination may be insufficient. Many people with partial sight use a long cane, swept from side to side or held diagonally, to aid in way-finding. People who are totally blind may use a guide dog.

## Appendix B: New MAAB Regulations

**18.6** To facilitate access to commuter rail vehicles, the following shall be provided:

**18.6.1** At newly constructed stations serving commuter rail coaches, access shall be provided to all passengers and to all coaches of the train by means of a raised platform. Such platforms shall be at least five feet (5') in clear width and shall have overhead shelter from rain and snow along a total of at least one hundred and fifty feet (150') of their length and at all access ramps.

For the purposes of this section, a newly constructed station is defined as any station stop where passenger service has not heretofore been provided or where no regularly scheduled passenger service has been provided for five (5) or more years.

**18.6.2** Any reconstructed, altered or remodeled stations serving commuter rail coaches shall afford access to at least two coaches of a train by means of a raised access platform. Such platforms shall be at least forty-five feet (45') in length and at least five feet (5') in clear width and shall, along their full length and at all access ramps provide overhead shelter from rain and snow. For the purposes of this section "reconstructed" shall have the definition of "reconstruction" in 521 C.M.R. Section 5.17, "altered" shall have the definition of "alteration" in 521 C.M.R. Section 5.4, and "remodeled" shall have the definition of "remodeling" in 521 C.M.R. Section 5.18.

**18.6.3** The distance between the raised platforms described in 18.6.1 or the raised access platform described in 18.6.2 and the floor of the entrance to the rail coach shall not exceed four inches (4") in the horizontal plane and two inches (2") in the vertical plane. Where construction constraints result in platform to vehicle gaps that exceed these standards, a bridge plate designed to eliminate such gaps shall be made available at every door of the vehicle where passengers are boarding or disembarking.

**18.6.4** The edge of all platforms at newly constructed, reconstructed, altered or remodeled stations shall have a yellow band of a different texture, distinguishable underfoot, and at least twenty-four inches (24") in width, warning of a danger zone.

**18.6.5** At all newly constructed, reconstructed, altered or remodeled stations, an unobstructed continuous path of travel shall connect all terminal buildings or station houses, platforms, parking areas designated for use by handicapped persons and street entrances.

**18.6.6** Within the station there shall be seating at intervals not to exceed two hundred fifty (250) feet.

### **Access Platform Stations**

#### **Providence Line**

Attleboro  
S. Attleboro  
Canton Center  
Canton Junction  
Hyde Park  
Mansfield  
Route 128  
Sharon  
Stoughton

#### **Milford/Franklin Line**

Dedham Corp.  
Forge Park  
Franklin (expedited)  
Norfolk  
Norwood Central  
Norwood Depot  
Readville  
Walpole

**Needham Line**

Bellevue  
Hersey  
Highland  
Needham Center  
Needham Heights  
Needham Junction  
Roslindale Village  
West Roxbury

**Worcester Line**

Wellesley Farms  
Wellesley Hills  
West Natick  
Yawkey Station

**Fitchburg Line**

Ayer  
Brandeis/Roberts  
Fitchburg  
Lincoln  
North Leominster  
Porter Square  
South Acton  
Waltham  
West Concord

**Lowell Line**

Lowell  
Mishawum  
North Billerica  
Wedgemere

**Haverhill Line**

Andover  
Ballardvale  
Bradford  
Haverhill  
Lawrence  
Melrose Highlands  
Reading



**Newburyport/Rockport Line**

Beverly Depot  
Beverly Farms  
Chelsea  
Gloucester  
Hamilton/Wenham  
Ipswich  
Manchester  
Montserrat  
North Beverly  
Rockport  
Salem  
Swampscott

**Plymouth Line/Old Colony**

Abington

**Greenbush Line/Old Colony**

Weymouth Landing

**Full Length Platform Stations**

**Providence Line**

Back Bay  
Forest Hills  
Providence  
Ruggles  
South Station

**Milford/Franklin Line**

Bellingham  
Milford

**Needham Line**

Veterans of Foreign Wars (V.F.W.)

**Worcester Line**

Ashland  
Framingham (Relocated)  
Grafton  
Southboro/Westboro  
Worcester

**Fitchburg Line**

Kendal Green (Relocated)

Littleton (Relocated)

**Lowell Line**

New Mishawum

**Haverhill Line**

Lawrence (Relocated)

Malden Center

North Station

**Newburyport/Rockport Line**

Lynn

Newburyport

Rowley

**Middleboro Line/Old Colony**

Braintree

Bridgewater

Brockton

Campello

Holbrook/Randolph

Middleboro

Montello

**Plymouth Line/Old Colony**

Kingston/Route 3

Halifax

Hanson

Plymouth

South Weymouth

Whitman

**Greenbush Line/Old Colony**

Cohasset

East Hingham

Greenbush

North Scituate

Nantasket Junction

West Hingham

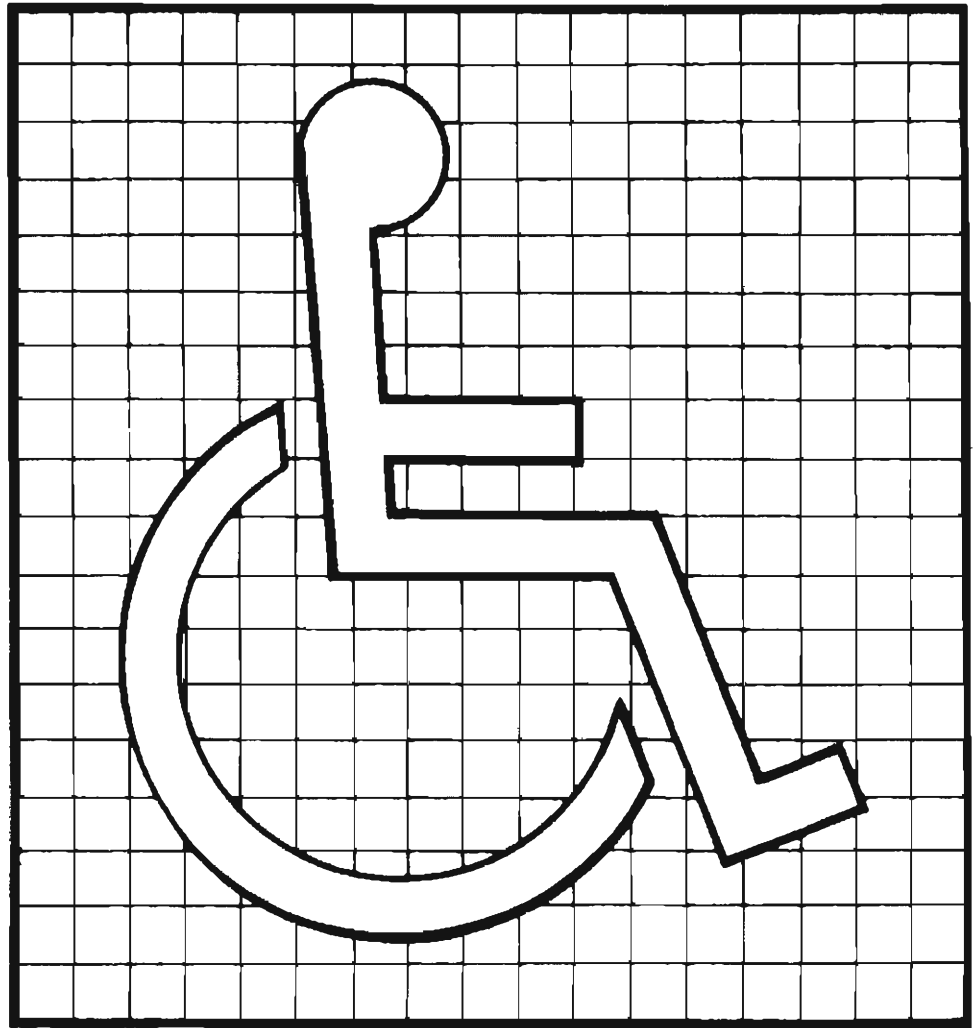



# INDEX

---

## Photo & Illustration Credits

All illustrations not listed below are original drawings by Damon Strub.

Illustrations credited to *Design for Access* were previously published by Adaptive Environments Center/Welch & Epp Associates in cooperation with Barrier Free Environments.

Illustrations credited to *Access Improvements Workbook* were previously published by Adaptive Environments Center/Welch & Epp Associates.

Illustrations credited to *The System* were previously published by and used with permission from Barrier Free Environments.

Illustrations credited to *Accessibility Modifications*, *Accessibility in Georgia*, or *An Illustrated Handbook of the Handicapped Section of the North Carolina State Building Code* were prepared by Barrier Free Environments for those publications.

Page	Source
10	Courtesy of Edward Steinfeld; concept developed by Rolf A. Faste
31	<i>Design for Access</i>
32	<i>Design for Access</i>
34, top	<i>Accessibility in Georgia</i>
34, bottom	<i>Design for Access</i>
35, bottom	Adapted from <i>Accessibility Modifications</i>
37	Adapted from <i>Accessibility in Georgia</i>
38	<i>Accessibility in Georgia</i>
41, top	<i>Design for Access</i>
50, top left	<i>Accessibility in Georgia</i>
50, top right	<i>Design for Access</i>
50, bottom	<i>Access Improvements Workbook</i>
51	<i>Access Improvements Workbook</i>
74, far left	<i>An Illustrated Handbook of the Handicapped Section of the North Carolina State Building Code</i>
74, center	Adapted from <i>California State Accessibility Standards Interpretive Manual</i> , Office of the State Architect
74, right	<i>Design for Access</i>
75	<i>Accessibility Standards Illustrated</i> , State of Illinois
76, left	<i>An Illustrated Handbook of the Handicapped Section of the North Carolina State Building Code</i>
76, right	<i>The Do-able, Renewable Home</i> , American Association of Retired Persons

Page	Source
77, top left	<i>The Do-able, Renewable Home</i> , American Association of Retired Persons
77, top right	<i>An Illustrated Handbook of the Handicapped Section of the North Carolina State Building Code</i>
82	<i>Design for Access</i>
84	<i>Accessibility Standards Illustrated</i> , State of Illinois
85	<i>Design for Access</i>
86	<i>Accessibility in Georgia</i>
95	<i>Design for Access</i>
96, top	<i>Design for Access</i>
96, bottom	<i>The Do-able, Renewable Home</i> , American Association of Retired Persons
97	<i>Access Improvements Workbook</i>
98	Adapted from <i>Accessibility in Georgia</i>
99, top	<i>Accessibility Standards Illustrated</i> , State of Illinois
99, bottom	<i>Accessibility in Georgia</i>
100	<i>The Do-able, Renewable Home</i> , American Association of Retired Persons
115	<i>Accessibility Standards Illustrated</i> , State of Illinois
116	<i>Design for Access</i>
121	<i>The System</i>
122, top	<i>The System</i>
122, bottom	<i>Accessibility in Georgia</i>
123	<i>The System</i>
124	<i>The System</i>
126	Copyright National Association for the Deaf
134	<i>Retrofitting Public Restrooms for Accessibility</i> , Peoples Housing, Inc.
135, top	<i>Retrofitting Public Restrooms for Accessibility</i> , Peoples Housing, Inc.
135, bottom	<i>Design for Access</i>
136, top	<i>Access Improvements Workbook</i>
136, bottom	<i>Design for Access</i>
137	<i>Design for Access</i>
139	<i>Design for Access</i>
140	<i>Access Improvements Workbook</i>
142, bottom	<i>The System</i>
143	<i>The System</i>
145	<i>Accessibility in Georgia</i>
146	<i>Design for Access</i>
147	<i>The System</i>
148, top	<i>Design for Access</i>
148, bottom	<i>Accessibility in Georgia</i>
149	<i>Design for Access</i>

## Index

- ABA 12, 13
- Access aisle 26, 31
- Access Board (*see* Standards)
- Accessibility, maintaining (*see* Maintaining access)
- Accessibility and the law 12–16
- Accessible route 22, 33–7, 92–4, 158, 160
  - alternate, during construction 181
  - approach to station 22
  - benches 93
  - catch basin 33, 36
  - change of direction 91, 92
  - circulation pattern 91
  - at commuter rail station 158, 160
  - corridor width 92
  - cross slope 35
  - curb cut (*see* Curb cut)
  - egress 94
  - fare collection 55
  - grating 36, 101
  - horizontal circulation 92–4
  - level change 35, 36
  - location 33
  - protruding objects 37
  - signage 33, 37, 93
  - slope 34–5, 92
  - surface 35
  - utility cover 36
  - width 34, 92
- Access platform 162–4
- Activating mat 51
- Activation switch 51
- ADA 12
- Advisory opinion 15
- Alarm 128
- Alert, fare collector 61, 62
- Amenities
  - at commuter rail platform 164, 167
  - emergency call box 94, 99, 127, 167
  - telephone (*see* Telephone)
  - TDD 125–6, 127, 179, 181
- American National Standards Institute 13
- American Sign Language 8
- Americans with Disabilities Act 12
- Amplification 126
- ANSI 13
- Approach, entrance
  - entrance 47
  - fare collection 57
- Architectural and Transportation Barriers
  - Compliance Board 12, 13
- Architectural Barriers Act 12, 13
- ATBCB 12, 13
- ASL 8
- At-grade track crossing 170–2
  - pros and cons 170
- Audible alarm 128
- Audible display 129
- Automatic door 51
- Barriers, construction 181
- Benches (*see* Seating)
- Beveled slope 99, 101, 168, 177, 178
- Blind (*see* Visual impairment)
- Blue Line (*see* Heavy rail)
- Bollards 32
- Booth, fare collection 55, 58–61
  - clear space 58, 60
  - chair 61
  - controls 61
  - counter 58
  - interior 59–61
  - level changes 60
  - orientation 59
  - speak-thru 59
  - window 58–9
- Braille (*see* Tactile signage)
- Bridge plate 165
- Bridge 22
- Built-in sink 145
- Busway 33
- Buttons, elevator 83, 85
- Cab, elevator 80
- Call box, emergency 94, 99, 127, 167
- Call panel, elevator 85
- Canopy 48, 166, 168
- Car/platform gap 110, 165–6
  - bridge plate 165
- Cash box 30, 158
- Catch basin 33, 36
- Chair 61

- Change machine 63–4
- Circulation
  - horizontal (*see* Horizontal circulation)
  - vertical (*see* Vertical circulation)
- Circulation space 34, 92
- Civil defense trains 161
- Cleaning 181
- Clear opening 50, 95–7
- Clear space
  - door 97
  - drinking fountain 123
  - fare collection booth 58, 60
  - signage 116
  - telephone 126
- Closed fist test 99, 124, 127, 145
- Closer 98, 100, 178
- Coat hook 139
- Code (*see* Standards)
- Collection box, parking fee 30, 158
- Column, structural 105
- Communication access symbols 126
- Commuter rail 3, 155–174
  - accessible pedestrian route 160
  - access platform 162–4
  - amenities 164, 167
  - benches 164, 169
  - bridge plate 165
  - canopy 48, 166, 168
  - car/platform gap 165–6
  - clearance requirements 161
  - entrance 174
  - floor 174
  - parking 158
  - passenger loading zone 158–9
  - pathway 160
  - platform (*see also* Platform) 161–9
  - railing 167
  - ramp 166, 173
  - shelter (*see also* Shelter) 168–9
  - site 157–60
  - stairs (*see also* Stairs) 166
  - station house 174
  - station layout 157
  - ticket window 174
  - toilet room (*see also* Toilet room) 174
  - track crossing (*see also* Track crossing) 170–3
  - vendor 174
- Compliance 15
- Construction barriers 181
- Contrast, visual 77, 115
- Control panel
  - elevator 81, 82
  - fare collection booth 61
- Cord, telephone 126, 179
- Corridor 100
- Counter
  - fare collection 58
  - vendor 130
- Cross slope
  - parking lot 27
  - pathway 35
  - platform 108
- Curb
  - vs. bollards 32
  - design 39
- Curb cut 26, 38–41, 171
  - corner-type 38–9
  - design 39, 171
  - flared 39, 171
  - lip 40
  - location 38, 171
  - returned 39
  - surface 41, 171
- Curbside parking 29
- Deaf (*see* Hearing impairment)
- Design summary, schematic
  - entrance 46
  - fare collection 56
  - horizontal circulation 91
  - platform 106
  - site 24
  - vertical circulation 70
- Designated route (*see also* Accessible route)
  - through parking lot 27
- Direction signaling 85, 87
- Disabilities and design 7–9
- Dispensers 147
- Displays, audible and visual 129
- Doormat 101
- Door 95–100
  - automatic 51, 98
  - clear opening 50, 95–7



- clear space 97
- closer 98, 100, 178
- corridor 100
- doorway 95
- double-acting 49
- double leaf 96, 97
- egress 49, 99
- elevator (*see also* Elevator) 80, 84
- entry 50, 101
- existing 96, 98
- glass 50
- handle 99
- hardware 99, 138–9
- to hazardous areas 100
- hinge 96, 138, 178
- kick plate 100
- knob 99, 138
- lock 138
- maneuvering space 97
- mat 101
- pivot 50, 96
- pressure 98, 178
- push plate 99
- revolving 51
- slide bar 138
- sliding 51
- swinging bar 138
- threshold 99, 178, 179
- toilet room 100, 133–4
- toilet stall 137, 138–9
- vestibule 49, 101, 133–4
- width 95, 96
- Drainage 33, 47
- Drinking fountain 121–4
  - alcove-mounted 121
  - clear space 123
  - control 124
  - dual-level 123
  - freestanding 123
  - knee space 122
  - location 121
  - parallel approach 123
  - recessed 121
  - spout 124
  - wall-mounted 122
- Drop-off area (*see* Passenger loading zone)
- Egress 49, 80, 94, 99
- Elevator 68–9, 80–7, 178
  - alarm 83, 178
  - Arabic numerals vs. braille 83
  - breakdown 61, 68, 178
  - buttons 83, 85
  - cab size 80
  - call panel 85
  - control panel 81, 82
  - direction signal 85, 87
  - door-jamb floor designation 86
  - door reopening device 83
  - door 80, 84
  - emergency buttons 82
  - emergency system 83
  - floor identification numbers 83
  - glass 69
  - handrail 82
  - inclined 69
  - intercom 83
  - leveling 85
  - lighting 82
  - in parking garage 29
  - perforated plate 83
  - position indicator 87
  - repair (*see also* Maintaining access) 178
  - self-leveling mechanism 85
  - telephone 82, 178
  - two-door 81
  - Update Line 83, 178
- Emergency alarm 128
- Emergency call box 94, 127, 167
- Emergency egress 49, 94
- Employee areas (*see also* Toilet room) 3, 59–60
- Employee toilet room (*see* Toilet room)
- Enclosed shelter 169
- Entrance 45–51, 178
  - approach 47
  - door 50, 101
  - landing 47–8
  - level changes 47
  - primary 45
  - schematic design 45–6
  - schematic design summary 46
  - signage 48, 117
  - vestibule 49, 101, 133–4

- Entry door 50, 101
- Escalator 75, 118, 178
- Fare collection 55–61, 178
  - accessible gate 59, 61, 62
  - accessible route 55
  - alert 61, 62
  - approach 57
  - booth (*see also* Booth) 55, 58–61
  - clear space 58, 60
  - control panel 61
  - counter 58
  - gate 59, 61, 62
  - location 55
  - parallel approach 58
  - resting places 57
  - schematic design 55–6
  - schematic design summary 56
  - seating 57
  - speak-thru 59
  - ticket/token vending machine 63–4
  - turnstile 62
  - window 58–9
- Faucet 145, 146
- Federal access code (*see* Standards)
- Federal agencies 13
- Federal laws and regulations (*see* Standards)
- Federal variance 14
- Fire extinguisher (*see* Amenities)
- Fixture, lighting 180
- Floor surface 101–2, 179
  - changes in materials 101
  - jointed 35
  - maintenance 179
  - non-slip 57, 73, 76, 101, 102, 107, 108–9
  - soft 35
  - uneven 35
  - unit flooring 101, 107
- Fountain, drinking (*see* Drinking fountain)
- Framingham line 170, 172
- Freight trains 161
  - Full-length mirror 148
  - Full-length raised platform 156, 162–3
  - Functional limitations 10–1
  - Garage, parking 26, 28, 29
  - Gate, fare collection 59, 61, 62
- General Services Administration 13, 14, 94
- Glare 115
- Glass door 50
- Glass elevator 69
- Grab bar 136, 137, 140–1
  - location 140
  - design 141
- Grating 36, 101
- Green Line 2
- GSA 13, 14, 94
- Guard rail 167
- Handicap, temporary 1, 9
- Handle (*see* Hardware)
- Handrail
  - design 74, 79
  - elevator 82
  - extension 74, 78
  - gripping surface 79
  - location 77
  - maintenance 181
  - mounting 73, 78
  - ramp 73–4
  - shape 74
  - stairs 77–9
- Hardware, door 99, 138–9
- Headhouse 21–2, 174
- Hearing impairment
  - description 8
  - functional limitations 10–1
- Heavy rail 2, 21–149
- High speed lines 170, 172
- Hinge 96, 138, 178
- Historic building 14, 15, 174
- Horizontal circulation 91–102
  - accessible route (*see also* Accessible route) 92–4
  - benches 57, 93, 111, 164, 169
  - change of direction 91, 92
  - circulation pattern 91
  - doors and doorways (*see also* Door) 95–100
  - egress 49, 80, 94, 99
  - floor (*see also* Floor surface) 101–2
  - pattern 91
  - schematic design 91
  - schematic design summary 91
  - signage (*see also* Signage) 93
  - slope 92
  - travel distances 91

- width 92
- Hot air dryer 147
- Illumination (*see* Lighting)
- Impracticability 14, 16
- Inclined elevator 69
- Inductive coil 126, 179
- Intercom 83, 94
- Interior station elements 115–130
  - alarm 128
  - drinking fountain (*see also* Drinking fountain) 121–4
  - emergency call box 99, 127, 167
  - public address system 120
  - reader board 120, 129
  - signage (*see also* Signage) 115–9
  - telephone and TDD (*see also* Telephone) 125–6
  - video monitor 129
- International Symbol of Accessibility 3, 27, 29, 48, 62, 93, 117, 118, 177, 211
- Jurisdiction issues 156
- Kick plate 100
- Knee space
  - under drinking fountain 122
  - under sink 145
- Landing
  - entrance 47–8
  - ramp 72
- Lavatory (*see* Toilet room)
- Laws (*see* Standards)
- Level change (*see* Vertical circulation)
- Lift 47, 70, 166
- Light rail 2
- Lighting
  - elevator 82
  - fixture 180
  - level 180
  - maintenance 180
  - signage 180
- Lock 138
- Lot, parking (*see also* Parking) 25
- MAAB (*see* Standards)
- Maintaining access 3, 177–81
  - accessible route 177
  - cleaning 181
  - construction 181
  - elevator 178
  - entrance 178
  - escalator 178
  - fare collection 178
  - floor 179
  - handrail 181
  - lighting 180
  - parking lot 177
  - platform edge 179
  - seasonal 180
  - signage 180
  - stairs 179
  - tactile materials 179
  - telephone 178–9
- Map
  - spider 117
  - tactile 116
- Massachusetts Architectural Access Board (*see* Standards)
- Massachusetts Commission for the Blind 16, 83, 108
- Massachusetts Commission for the Deaf and Hard of Hearing 16
- Massachusetts Department of Public Works 40
- Mat 101
- MBTA accessibility requirements (*see* Standards)
- MCDHH 16
- Mirror 148
- Mobility impairment
  - description of 9
  - functional limitations 10–1
- Monitor 129
- Noise Operated Automatic Level Adjustment (NOALA) 120
- Non-compliance penalties 15
- Non-slip surface
  - floor 57, 101, 102, 107, 108–9
  - platform 107, 108
  - ramp 73
  - stairs 76
- Nosing 76
- Obstructions 37, 109
- Office of Handicapped Affairs 16
- Office of Transportation Access 158
- Offset hinge 96
- Orange Line (*see* Heavy rail)
- Overhead signage 37

- Overpass 170, 172-3
  - pros and cons 170
- P.A. system 120, 129
- Paper dispenser, toilet 142
- Paper towel dispenser 147
- Parking 23, 25-30
  - access aisle 26, 31
  - cash box 30, 158
  - cross slope 27
  - curbs vs. bollards 32
  - curbside 29
  - designated route 27
  - fee collection box 30, 158
  - garage 26, 28, 29
  - lot 25
  - maintenance 177
  - signage 27, 29, 158
  - slope 27
  - spaces 25-6
  - structure 26, 28, 29
  - van 26, 28
- Passenger assistance area 94
- Passenger loading zone 23, 31-2
- Pathway
  - cross slope 35
  - protruding objects 37
  - slope 34
  - surface 35
  - width 34
- Pavers, brick and concrete 101
- Pedestrian aisle 160
- Pedestrian approach to station 22
- Penalties, non-compliance 15
- Perforated plate 83
- Pictograph 64, 119, 126
- Pipe protection 146
- Pivot door 50, 96
- Platform 105-11
  - access 162-4
  - amenities 164
  - benches 105, 111, 164, 169
  - bridge plate 165
  - canopy 48, 166
  - commuter rail 161-9
  - circulation space 105
  - clear width 105
  - columns 105
  - construction 181
  - cross slope 108
  - edge 108-9, 163, 179
  - full-length raised 156, 162-3
  - lift 47, 70, 166
  - materials 107
  - obstructions and protruding objects 109
  - platform/car interface 110
  - schematic design 105-6
  - schematic design summary 106
  - signage 110, 119
  - slope 107-8
  - station ID 119
  - structural elements 106
  - surface 107, 108
  - tactile edge treatment 108-9, 163, 179
  - train stopping point 106
  - vertical lift 47, 70, 166
  - visual edge treatment 108, 163, 179
  - width 105
- Platform/car interface 110
- Police call box 94, 99, 127, 167
- Power-operated door (*see* Automatic door)
- Primary entrance 45
- Private toilet room 149
- Protruding objects 37, 109
- Providence line 170, 172
- Public address system 120, 129
- Public toilet room (*see* Toilet room)
- Push-button telephone 126
- Push plate 99
- Rail (*see* Handrail)
- Railing 167
- Raised platform, full-length 156, 162-3
- Raised print (*see* Tactile signage)
- Ramp 71-4, 166, 173
  - edge protection 74
  - handrail (*see also* Handrail) 73-4
  - landing 72
  - length 72
  - location 71
  - roof 34, 47, 73, 166, 173
  - slope 71
  - surface 73
  - used with stairs 166

- width 72
- Reach, forward and overhead 63
- Reader board 120, 129
- Recessed drinking fountain 121
- Red Line (*see* Heavy rail)
- Redundancy 8–9
- Regulations (*see* Standards)
- Rehabilitation Act 12, 13
- Reopening device, elevator door 83
- Repairs (*see* Maintaining access)
- Rest room (*see* Toilet room)
- Revolving door 51
- The RIDE 23, 31, 45
- Riser, open 76
- Roof (*see* Shelter)
- Safety railing (*see* Railing)
- Sawhorse 181
- Schematic design summary
  - entrance 46
  - fare collection 56
  - horizontal circulation 91
  - platform 106
  - site 24
  - vertical circulation 70
- Seasonal maintenance 180
- Seat, toilet 143
- Seating 57, 93, 111, 164, 169
- Section 504, Rehabilitation Act 12, 13
- Self-service vendor 130
- Shelter 168–9
- Sidewalk 26, 27
  - “shoreline” 38
- Signage 115–9
  - accessible route 33, 37, 93
  - clear space 116
  - contrast 115
  - entrance 48, 117
  - escalator 118
  - glare 115
  - lighting 115
  - maintenance 180
  - overhead 37
  - parking 27, 29, 158
  - passenger assistance area 94
  - placement 93, 117, 118
  - platform 110, 119
  - spider map 117
  - stairs 118
  - station ID 119
  - tactile (*see* Tactile signage)
  - telephone 126
  - toilet room 118
- Sink 145–7
  - built-in 145
  - clearance 145
  - faucet 145, 146
  - knee space 145
  - mounting height 145
  - pipe protection 146–7
  - soap dispenser 147
  - type 145
- Site 21–41
  - accessible route (*see also* Accessible route) 22, 33–7
  - headhouse 21–2
  - schematic design 21–4
  - schematic design summary 24
  - sloping 22, 94
- Slide bar 138
- Sliding door 51
- Slope
  - accessible route 92
  - beveled 99, 101, 168, 177, 178
  - parking 27
  - platform 107
  - ramp 71
- Sloping site 22, 94
- Soap dispenser 147
- Spaces, accessible parking 25–7
- Speak-thru 59
- Speechreading 58, 59
- Spider map 117
- Spout, drinking fountain 124
- Stairs 75–9, 166, 179
  - covering 166
  - freestanding 75
  - handrail (*see also* Handrail) 77–9
  - landing 78
  - maintenance 179
  - nosing 76
  - riser 76
  - signage 118

- step edges 77
- surface 76
- switchback 78
- tread 76
- used with ramps 166
- Stall, toilet (*see* Toilet stall)
- Standards
  - federal code (UFAS) 2, 3, 12, 13
  - MBTA requirements 2
  - new regulations 160, 205–9
  - state code (MAAB) 2, 12, 14
- State access code (*see* Standards)
- State agencies 16
- State laws and regulations (*see* Standards)
- State variance 15–6
- Station elements (*see* Interior station elements)
- Station house 174
- Station ID 119
- Station layout, commuter rail 157
- Step edges 77
- Stracnet 161
- Structural column 105
- Structure, parking 26, 28, 29
- Surface
  - curb cut 41, 171
  - floor (*see also* Floor surface) 101–2, 179
  - jointed 35
  - non-slip 57, 73, 76, 101, 102, 107, 108–9
  - pathway 35
  - platform 107, 108
  - ramp 73
  - soft 35
  - textured 32, 39, 41, 77
  - track crossing 171
  - uneven 35
- Sustaining access (*see* Maintaining access)
- Swinging bar 138
- Switchback
  - ramp 72
  - stairs 78
- Swivel chair 61
- Tactile signage
  - braille 116
  - height 48, 116
  - lettering 83, 116
  - map 116
  - uses 48, 64, 83, 115, 118, 127
  - Tactile warning (*see* Surface)
- Tank toilet 140, 142–3
- TDD 125–6, 127, 179, 181
- Technical assistance 16
- Telecommunication Device for the Deaf
  - 125–6, 127, 179, 181
- Telephone 125–6, 167, 178–9
  - amplification 126
  - books 179
  - clear space 126
  - cord length 126, 179
  - elevator 82, 178
  - features 126, 179
  - height 126, 179
  - inductive coil 126, 179
  - knee space 125
  - maintenance 178
  - push-button 126
  - signage 126
  - volume control 126, 179
  - wall-mounted 125
- Teletypewriter (*see* TDD)
- Temporary handicap 1, 9
- Textured surface 32, 39, 41, 77
- Threshold 99, 178, 179
- Ticket booth (*see* Booth, fare collection)
- Ticket/token/change machine 63–4
- Toilet 142–3
  - floor-mounted 142
  - flush control 143, 145
  - flush-valve 140, 142–3
  - paper dispenser 142
  - recessed base 142
  - seat height 143
  - tank 140, 142–3
  - type 142–143
  - wall-mounted 142
- Toilet room 133–49
  - coat hook 139
  - dispensers 142, 147
  - entry door 100, 133–4
  - grab bar 136, 137, 140–1
  - maneuvering space 135
  - mirror 148
  - paper dispenser 142

- private 149
- signage 118
- sink (*see also* Sink) 145–7
- stall (*see also* Toilet stall) 142–3
- stall door 137, 138–9
- toilet (*see also* Toilet) 142–3
- unisex 149
- urinal 144–5
- vestibule 133–4
- wall reinforcement 141
- Toilet stall 136–41
  - dimensions 136–7
  - door 137, 138–9
  - grab bar 136, 137, 140–1
  - hardware 138–9
  - with sink 139
- Track crossing 170–3
  - at-grade 170–2
  - methods, pros and cons 170
  - overpass 170, 172–3
  - underpass 170, 173
- Train stopping point 106
- Trash can 147
- Tread 46
- Trees 37
- TTY (*see* TDD)
- Turnstile 62
- UFAS (*see* Standards)
- Uncurbed intersection 39
- Underpass 170, 173
  - pros and cons 170
- Uniform Federal Accessibility Standards (*see* Standards)
- Unisex toilet room 149
- Unit flooring 101, 107
- Urban Mass Transportation Act 12
- Urinal 144–5
- Utility cover 36
- Van parking 26, 28
- Variance 14–6, 46, 49
  - appeal of variance denial
  - federal 14
  - state 15–6
- Vending machine 130
  - ticket/token/change 63–4
- Vendor 130
- Vertical circulation 67–87
  - elevator (*see also* Elevator) 68–9, 80–7
  - escalator 75, 178
  - inclined elevator 69
  - lift 47, 70, 166
  - ramp (*see also* Ramp) 67–8, 71–4
  - schematic design 67–70
  - schematic design summary 70
  - stairs (*see also* Stairs) 67–8, 75–9
- Vertical platform lift 47, 70, 166
- Vestibule 49, 101, 133–4
- Video monitor 129
- Visual alarm 128
- Visual display 129
- Visual impairment
  - description 8
  - functional limitations 10–1
- Visual platform treatment 108, 163, 179
- Volume control, telephone 126, 179
- Walkway (*see* Pathway)
- Wall reinforcement 141
- Warning signal (*see* Alarm)
- Waste receptacle 147
- Water fountain (*see* Drinking fountain)
- Wayfinding (*see* Signage)
- Weather 48
- Wheelchair
  - dimensions 58, 60
  - manual 9, 107, 108
  - motorized 9
  - reach 63
  - turning space 58, 60, 64, 164
- Wing-walls 109