

Elevator Design Standard

**July 31, 2017
(9th Revision)**

BACKGROUND

With almost 180 elevator units in service and elevator availability and reliability averaging 99.9%, the Massachusetts Bay Transportation Authority (MBTA) seeks to standardize and over time, greatly reduce the number of variations in design of the MBTA's elevator equipment inventory and improve both service reliability and the passenger experience.

Staff from the MBTA, Greater Boston Legal Services, Institute for Human-Centered Design (Formerly Adaptive Environments), Lerch Bates and Vertical Transportation Excellence (VTX) developed this document to define the minimum elevator design standards required by the MBTA for their system-wide facilities. Human Centered and Universal Design principles were used to develop the Elevator Design Standard (Standard) in an effort to enhance accessibility for all MBTA customers. Design standards are intended to address both the physical characteristics of the elevator system designs and underlying technical parameters necessary to provide accessible, reliable and available elevators to all MBTA customers.

Document Revision History				
Rev No	Rev Date	Description of Revision(s)	Rev By	Approval
00	12/19/07	First edition of document		
01	04/07/08	HVAC, Camera, etc.		
02	06/30/08	Edits to 3.1.2.1, 3.2.3, 3.3.1, 3.5.3.2, 3.3.2, 3.4.1, 3.4.2, 3.5.2, 3.5.3.2, 4.0, 8.0 Removed Section 2.11 E from Appendices D & E	SWA	
03	2/20/10	Edits to 1.0, 2.0	SWA	
06	5/15/2010	Edits to 1.0, 4.2, 4.3,1 4.4.2, 4.4.4, 4.4.6, 4.5.1.4, 4.5.2, 4.5.3.2, 4.5.3.3, 4.5.3.4.1, 4.5.3.5, 4.5.3.6, 4.7, 5.0,, 6.0, 7.2, 8.0, 9.0, Appendices B&C, D.1.3, D.1.5, D.1.6.A.3, D.1.6.B, D.1.7.A, D.1.7.14, D.1.8.C, D.1.8.E, D.1.10.A, D.1.10.D.3.A, D.1.10.D.3.B, D.1.12.A, D.1.15.B, D.15.H.1, D.2.3, D.2.4.A.18 22 26, D.2.5.A.10, D.2.5.A.2.D, D.2.9.B.5, D.2.10.A.2.D, D.2.10.C.4C.2, D.2.11.B.3, D.2.14.E, D.3.3, E.1.3, E.1.5, E.1.6.A.3, E.1.6.B, E.1.7.A, E.1.7.14, E.1.8.C, E.1.10.A, E.1.10.D.3.B, E.1.12.A, E.14.A, E.1.15.B, E.15.H.1, E.2.3, E.2.4.A23 28, E.2.5.A.10, E.2.10.A.2.D, E.2.10., E.2.11.B&D, E.3.3., Appendix F, Appendix G	SWA	
07	4/1/11	Edits to Appendix A, Appendix C, Appendix D, Appendix E, 3.2, 4.5.1.1 thru 4.5.1.6, 4.5.2, 4.5.3.2, 4.5.3.3, 7.1, 8.0, 9.0	STS/WK	
08	5/17/11	Edits to Table of Contents, 4.5.2, ADVISORY NOTE 4.5.3, 4.5.3.2, 4.5.3.4.1, Added Appendix B Part 1 and 2, Added Appendix C Part 1 and 2, Added Appendix D Part 1 and 2, Added Appendix E Part 1 and 2, Added Appendix F Part 1 and 2, Added Appendix G	STS/WK	
09	7/31/2017	Edits to Background, Table of Contents, 1.0, 2.0, 2.1, 3.2, 3.3, 3.4, 4.1.1, 4.1.2, 4.1.2.1, 4.1.2.2, 4.1.2.3, 4.1.3, 4.2, 4.2.1, 4.2.1.1, 4.2.2, 4.3.1, 4.4.1, 4.4.2, 4.4.3, 4.4.4, 4.4.6, 4.5, 4.5.1.1, 4.5.1.2, 4.5.1.2.a., 4.5.1.3, 4.5.1.4, 4.5.1.5, 4.5.1.6, 4.5.1.7,	STS/AER	

Document Title: MBTA Elevator Design Standard	Rev No.: 09 Rev Date: 7/31/2017	Page: ii of vi
--	--	--------------------------

09 continued	7/31/2017	4.5.2, 4.5.3.1, 4.5.3.2, 4.5.3.2.a, 4.5.3.4.1, 4.5.3.4.2, 4.5.3.4.3, 4.5.3.4.4, 4.5.3.3.4.5, 4.5.3.5, 4.6.1, 4.6.2, 4.7, 5.0, 5.1, 6.0, 7.1, 7.2.1, 7.2.3, , 8.0, 9.0, 10.0, 11.0, 12.0, 13.0, 13.1, 13.2, 13.3, Appendix A – Part 1 and Part 2 revised advisory notes and replaced graphics plans and section thrus, Appendix B - Part 1 and 2 replaced and added additional graphics and added advisory note, Appendix E - revised advisory notes and replaced graphics, Appendix F – replaced Part 1 graphics. Added Appendix H: Elevator Related Signage Design Requirements	STS/AER	
-----------------	-----------	---	---------	--

Table of Contents:

Background iv

Glossary of Elevator Terms iv

1.0 Intent 1

2.0 Scope of Document 1

3.0 Applicable Standards, Codes and Guidelines 2

4.0 Elevator System Design Requirements 4

5.0 Architectural Design Requirements 24

6.0 Civil\Structural Design Requirements 25

7.0 Mechanical Design Requirements 25

8.0 Electrical Design Requirements 26

9.0 Communications Design Requirements 27

10.0 Security Requirements 29

11.0 Utility Requirements 29

12.0 Signage and Wayfinding Requirements 29

13.0 Turn-over Requirements 30

APPENDIX A Minimum Elevator Configuration Dimensions A1
 Part 1 - ADA
 Part 2 – ADA w/Stretcher

APPENDIX B Car Operating Panel Design Requirements B1
 Part 1 – Main Car Operating Panel
 Part 2 – Auxiliary Car Operating Panel

APPENDIX C Hall Call Station Design Requirements C1
 Part 1 – Hall Call Station- Upper Level
 Part 2 – Hall Call Station- Intermediate Level
 Part 3 – Hall Call Station- Lower Level

APPENDIX D Hall Lantern Design Requirements D1
 Part 1 – Hall Lantern- Upper Level
 Part 2 – Hall Lantern- Intermediate Level
 Part 3 – Hall Lantern- Lower Level

APPENDIX E Entrance Door Design Requirements E1
 Part 1 – Entrance Doors with Full Glass
 Part 2 – Entrance Doors with Vision Panels

APPENDIX F Elevator Cab Door Design Requirements F1
 Part 1 – Cab Doors with Full Glass
 Part 2 – Cab Doors with Vision Panels

APPENDIX G Elevator Cab Lighting Design Requirements G1

APPENDIX H Elevator Related Signage Design Requirements H1
 Part 1 – Single Elevator with Signage
 Part 2 – Duplex Elevators with Signage
 Part 3 – Signage Details and Requirements

Document Title: MBTA Elevator Design Standard	Rev No.: 09 Rev Date: 7/31/2017	Page: iv of vi
---	------------------------------------	-------------------

Glossary of Elevator Terms:

Heavy duty elevator: An elevator designed specifically for the harsh environment and duty load cycles common to transportation system usage.

Elevator: A hoisting and lowering mechanism, equipped with a car or platform, which moves in guide rails or racks and serves two or more landings.

Elevator, passenger: An elevator used primarily to carry persons other than the operator and persons necessary for loading and unloading.

Elevator, hydraulic: A power elevator in which the energy applied, by means of a liquid under pressure, in a hydraulic jack.

Elevator, electric traction: A power elevator in which the energy applied by means of an electric driving machine.

Machine Room Less (MRL) Elevator: A traction drive based drive elevator system using wire ropes and sheaves with the drive machinery located within the elevator hoistway rather than in a separate machine room. An equipment room is required to house the elevator controller and related ancillary equipment.

Direct Acting Hydraulic: An elevator system that utilizes a hydraulic cylinder attached directly to the elevator cab structure at, or near, the elevator cab center line.

Elevator Cab: The moving enclosure of an elevator that provides transportation of passengers from one level to another.

Elevator Door: Power operated doors with mechanical linkages and interlocking systems that allow passenger entry or exit from the elevator and serve to contain passengers within the elevator cab during movement.

Hoistway Door: Power operated doors with mechanical linkages and interlocking systems that allow passenger entry or exit from the elevator and serve to obstruct access to the elevator hoistway when a cab is not present or is moving within the hoistway.

Document Title: MBTA Elevator Design Standard	Rev No.: 09 Rev Date: 7/31/2017	Page: v of vi
---	------------------------------------	------------------

Elevator Hoistway: The vertical passageway used by an elevator to move passengers from one destination to another. The hoistway includes the structural elements to form the passageway, isolate the moving elevator systems from the public, and provide support for key elevator components such as rails and machine beams.

Elevator Pit: The lower end of the elevator hoistway that provides clearances for the elevator components when the elevator cab is located at the lowermost point of travel. The pit contains access ladders, floor drainage and buffers (similar to shock absorbers) to minimize potential impacts in the event an elevator travels past its lowermost intended position.

Car Call Station: The operating panel for an elevator that is used by passengers to indicate the landing to be traveled to.

Elevator Landing: A finish floor level within a facility that is designed as a stop for an elevator to either pick up or discharge passengers. All referred to as a “stop”.

Elevator Availability: Availability is the percentage of time that an elevator is fully operational for passenger use versus the corresponding time that the MBTA station is open for operation.

Elevator Reliability: Reliability is the percentage of time that an elevator is fully operational for passenger use versus the corresponding time that the MBTA station is open for operation minus time out of service for routine preventive maintenance. Service failures requiring emergency repairs during normal operational hours deduct from the fully operational time period for the elevator in the assessment of reliability.

Single Elevator Cycle Starting at the lowest landing and proceeding up to the upper landing, stopping at each landing for a minimum of 10 seconds, then proceeding back down to the lowest landing stopping again at each landing for a minimum of 10 seconds

Document Title: MBTA Elevator Design Standard	Rev No.: 09 Rev Date: 7/31/2017	Page: vi of vi
--	------------------------------------	-------------------

Elevator Response Times:

- **Service Failure** – company must respond and be on site within one hour when notified of the failure
- **Emergency** - company must respond and be on site within 45 minutes when notified of the emergency
- **Entrapment** - company must respond and be on site within 30 minutes when notified of the entrapment

Interim Maintenance – planned monthly maintenance during the warranty period

Warranty Period – starts with the MBTA acceptance of the elevator for public use

Travel – the distance from the lowest landing to the uppermost landing

Travel Rise – the distance from the pit floor to the top of the hoistway

Document Title: MBTA Elevator Design Standard	Rev No.: 09 Rev Date: 7/31/2017	Page: 1 of 31
--	------------------------------------	------------------

1.0 Intent

This document exists to standardize and, over time, reduce the number of variations in design of the MBTA's new and replacement elevator equipment inventory and improve both service reliability and the passenger experience. The document captures code requirements as they exist upon publication date.

Where more stringent existing federal, state and local codes and standards apply they will be used in the design, installation, or servicing of elevator equipment unless the MBTA has applied for and received waivers for the design standard. The elevator designer is responsible for identifying any variances or waivers needed and preparing all materials for the MBTA to pursue variances and waivers.

2.0 Scope

All newly designed and constructed elevators and all elevator replacements shall comply with the requirements to the greatest extent possible.

2.1 Exceptions

Any condition or requirement within this document that cannot be met must be documented and approved prior to or in the 15% Conceptual Design phase by the MBTA's Capital Delivery, System-Wide Accessibility, Operations Support, and their vertical transportation consultant as well as any other pertinent MBTA departments. The documentation shall be done in a manner to satisfy Massachusetts Department of Public Safety (DPS) review.

The MBTA recognizes that elevator replacements may not be able to meet all requirements of this standard due to shaft size or other constraints. If physical constraints exist on replacement elevators the MBTA Elevator Standard shall be applied to the greatest extent possible without changing shaft dimensions unless shaft expansion is explicitly directed by the MBTA. The design professional or responsible design entity shall document to the MBTA Capital Delivery, System-Wide Maintenance and System-Wide Accessibility Departments all areas where this Standard cannot be met and propose options and potential remedies as well as identify risks, with rough order of magnitude costs for each department's acceptance.

Occupant Evacuation Elevators (OEE) were included in the 2009 International Building Code. OEE allows elevators to be used for evacuation purposes in certain instances and are required in instances where the building is over 400 ft. in height. While MBTA stations would not typically constitute the requirement of OEE, in certain cases of new construction, the inclusion of an OEE may be feasible. Before or during the 15% Conceptual Design Phase the designer will

Document Title: MBTA Elevator Design Standard	Rev No.: 09 Rev Date: 7/31/2017	Page: 2 of 31
---	--	-------------------------

submit an OEE Feasibility Report to MBTA’s Capital Delivery, System-Wide Accessibility, Operations Support Departments as well as any other pertinent MBTA departments and the Massachusetts Department of Public Safety. This report will include an initial evaluation of the feasibility of converting new or the existing elevator(s) into an OEE and shall include a lump sum estimate of the associated construction cost. The report shall also identify necessary approvals from Massachusetts Department of Public Safety and a schedule for acquiring said approvals.

3.0 Applicable Standards, Codes and Guidelines

3.1 Applicable Standards (most current editions):

- American National Standards Institute (ANSI)
- American Society of Civil Engineers (ASCE)
- American Society of Mechanical Engineers (ASME)
- American Society for Testing and Materials (ASTM)
- Electronic Industries Association (EIA)
- Insulated Cable Engineers Association (ICEA)
- Institute of Electrical and Electronics Engineers (IEEE)
- National Electrical Manufacturers Association (NEMA)
- National Fire Protection Association (NFPA)
- Occupational Safety and Health Administration (OSHA)
- Underwriters Laboratories, Inc. (UL)
- U.S. Department of Transportation (DOT/FTA)
- U.S. Department of Justice ADA
- Consumer Product Safety Commission (CPSC)
- Code of Federal Regulations (CFR)

3.2 Applicable Codes (most current editions):

- International Building Code (IBC)
- Massachusetts Architectural Access Board (MAAB), 521 CMR 28
- Massachusetts State Building Code, 780 CMR
- Massachusetts Elevator Regulations, 524 CMR
- Massachusetts Uniform State Plumbing Code, 248 CMR 10.0

Safety Code for Elevators and Escalators (ASME A17.1)
National Electrical Code (NFPA 70)
Fixed Guideway Transit and Passenger Rail Systems (NFPA 130)
NFPA 1 –, 527 CMR 1.00
Accessibility Code (ICC/ANSI A117.1)
49 CFR Parts 37/38

3.3 Applicable Guidelines (most current editions):

Americans with Disabilities Accessibility Guidelines for Buildings and Facilities (ADAAG – USDOT version)
Guide for Emergency Evacuation of Elevators (ASME A17.4)
American Public Transportation Association (APTA)

3.4 MBTA Related Specifications/Standards (most current editions):

Specification Section 10400	Fixed Signage
Specification Section 10424	Specialty Signage
Specification Section 10426	Tactile/Braille Signage
Specification Section 13700	Access Control System
Specification Section 13850	Fire Alarm Systems
Specification Section 14241	Electric Traction Elevators
Specification Section 14240	Hydraulic Elevators
Specification Section 15050	Basic Materials and Methods for Mech. Work
Specification Section 15400	Plumbing Systems
Specification Section 15600	Heating, Ventilating, and Air Conditioning
Specification Section 16050	Basic Materials and Methods for Electrical Work
Specification Section 16070	Electrical – Mechanical Interface
Specification Section 16500	Lighting
Specification Section 16705	Station Fire Alarm System
Specification Section 16710	Telephone Instruments

Document Title: MBTA Elevator Design Standard	Rev No.: 09 Rev Date: 7/31/2017	Page: 4 of 31
--	------------------------------------	------------------

Specification Section 16717	Loose Tube Optical Fiber Cable for Low-Smoke, Zero Halogen Applications and Ancillary Equipment
Specification Section 16750	Elevator Emergency Intercom System
Specification Section 16790	Communication Programmable Logic Controller
Specification Section 16840	Closed Circuit Television System

4.0 Elevator System Design Requirements

4.1 General Design Requirements

The following general design requirements shall be applied to all elevator system designs at the MBTA.

4.1.1 Master Specification(s)

Specific details of elevator system requirements for the MBTA are contained in master specifications for each elevator type authorized for use within the MBTA system. Master specifications shall be used for all MBTA elevator projects and are tabulated as follows:

Section 14241	Electric Traction Elevators
Section 14240	Hydraulic Elevators

4.1.2 Applicability of Design Standards

All elevators, including replacement elevators, shall be designed in full compliance with the requirements established within these design standards. All elevator replacements shall implement to the greatest extent possible all applicable elements contained in this Standard.

4.1.2.1 The responsible design entity shall document to the MBTA Capital Delivery, MBTA Engineering & Maintenance and MBTA System-Wide Accessibility Departments all areas where this Standard cannot be met and propose remedies for acceptance.

4.1.2.2 The Design Standard is NOT intended to be a substitute for, nor amendment to, any state or local requirements. In the case where the elevator system cannot meet a code requirement the designer will provide this information to MBTA. The notice will include the specific code violation and options for either addressing the deficiency or

Document Title: MBTA Elevator Design Standard	Rev No.: 09 Rev Date: 7/31/2017	Page: 5 of 31
---	------------------------------------	------------------

pursuing a variance with the Massachusetts Department of Public Safety.

4.1.2.3 If the adjacent stairway does not conform to 780 CMR 8th Edition then 524 CMR Chapter 17 item 17.40 (c) elevator stretcher requirements are in effect regardless of the number of stories.

4.1.3 **Design Process**

A preliminary design analysis study by qualified architectural and vertical transportation consulting firms shall be performed for each elevator project to assess integration of the MBTA design standards.

Existing elevators replaced within the MBTA system shall be assessed based on demolition and removal of the existing elevator system including machine room components. Assessments shall be based upon re-use of existing elevator hoistway, machinery spaces, and headhouses where possible provided that the elevator interior cab depth is at least 54" from the back wall to inside most elevator door panel for single entry/exit applications. For pass through applications, at least 54" from inside most door panel to inside most door panel. Door openings shall be at least 36" in width and in accordance with ADAAG and ANSI A117.1 requirements. As a level of standard, such dimensions have been found to accommodate longer power wheelchairs and scooters as well as some double strollers.

Existing elevator cabs, hoistways, or structures that do not meet requirements set forth in this Standard shall be assessed for feasibility of reconstruction to resolve non-compliance issues, including engineering cost estimates and schedules. Examples of non-conformances include, but are not limited to, the following: insufficient cab floor areas, insufficient door cab entry widths, lack of substantial transparency (particularly at landings and shafts that could become visible to platforms, stairs, lobbies) and insufficient roof overhangs at street level entrances. The feasibility study shall serve as a foundation for the MBTA System-Wide Accessibility to determine if the replacement effort will go forward with the non-conforming conditions or whether complete reconstruction shall be performed.

4.1.4 Elevator Load Ratings

All elevator systems shall be sized using APTA Guidelines for elevator load ratings. Load ratings, compared to standard ASME A17.1 ratings are tabulated as follows for various cab floor areas:

Platform			ASME A17.1		APTA
Width	Depth Front to Back	Net Area	Max inside Net Area	Rated Load	Rated Load
(ft)	(ft)	(ft ²)	(ft ²)	(lb)	(lb)
6.00	5.00	24.08	24.20	2000	3000
7.00	5.00	28.33	29.10	2500	3750
7.00	5.50	31.67	33.70	3000	4500
7.00	6.17	36.11	38.00	3500	5250
8.00	6.17	41.53	42.20	4000	6000
6.00	8.83	45.81	46.20	4500	6750
6.00	9.38	48.88	50.00	5000	7500

4.2 Elevator System Drive Technologies

Elevator systems shall primarily utilize Machine Room Less (MRL) systems and secondarily utilize direct acting hydraulic systems as the preferred drive technologies. Where MRL systems are not recommended, the elevator designer shall thoroughly document why MRL systems are not recommended for a given location and receive written MBTA consent to utilize hydraulic systems.

4.2.1 MRL Drive Technology

Machine Room Less (MRL) elevator drive technology shall be used for all elevators where overhead, pit conditions, capacity and travel permit. MRL systems can only be applied for the MBTA pass through (preferred) or single entry/exit cab configurations. Equipment rooms required to house elevator controllers, remote monitoring and related equipment shall be provided. In locations adjacent to escalators, equipment room sizing shall, to the extent practicable and allowable by code, be designed to also house escalator control equipment.

Maximum Elevator Rise: 100' 0" (30.48 m)

Maximum Cab Capacity: 5000 lb

Advisory Note 4.2.1.1: *The elevator contractor may be required to receive a MRL variance by the MA Board of Elevators for new MRL systems not previously accepted. This is solely the elevator contractor's responsibility. The MBTA will receive copies of any variance application and approval thereof.*

Document Title: MBTA Elevator Design Standard	Rev No.: 09 Rev Date: 7/31/2017	Page: 7 of 31
---	--	-------------------------

4.2.2 Direct Acting Hydraulic Drive Technology

Direct Acting Hydraulic Drive elevator systems shall be used for applications where overhead limitations, pit conditions, or capacity preclude the use of MRL technologies. Standard side mounted rail configurations, with balanced cabs, shall be used for all cab configurations except 90-degree door configurations requiring corner post arrangements. Direct acting hydraulic elevators shall not be used beyond the maximum total travel rise. Equipment rooms required to house elevator controllers, remote monitoring and related equipment shall be provided. In locations adjacent to escalators, equipment room sizing shall, to the extent practicable and allowable by code, be designed to also house escalator control equipment.

Maximum Elevator Rise: 40'-0" (12.19 m)

4.2.3 Cantilevered, Twin Post & Telescoping Hydraulic Elevators

Designs that include cantilevered, twin post and telescoping hydraulic elevator systems are not allowed.

4.3 Elevator Performance Requirements

4.3.1 General Performance Features:

Minimum elevator design speed under full rated load shall be greater than or equal to 100 fpm (0.5 m/s) for hydraulic elevators and 200 fpm (1.0 m/s) for MRL elevators.

Elevator controllers shall incorporate remotely programmable home floor configurations. Programming capabilities shall permit a minimum of two time-based home floor designations to respond to peak demands based on station passenger flows.

Doors shall remain fully open for a minimum of 5 seconds, and then close. Elevator controllers shall include programmable functions to extend door dwell times.

Elevators shall be provided with audible announcements inside the car indicating floor upon elevator arriving. Audible annunciation systems shall be remotely programmable to update messages. Refer to Section 9.0 for additional requirements of audible systems.

A visual indication shall be provided to identify the floor when doors are open.

The design shall include heavy duty elevators for 24 hours/day, 7 days/week use and in accordance with current APTA guidelines.

Document Title: MBTA Elevator Design Standard	Rev No.: 09 Rev Date: 7/31/2017	Page: 8 of 31
---	--	-------------------------

Design shall provide engineering analysis for using elevator and/or elevator lobby as emergency egress or area of refuge in accordance with all applicable codes and standards.

4.3.2 Elevator Design Availability

All elevators shall be designed for 100 percent availability for 24 hours/day, 7 days/week use regardless of the current operational times for the facility.

4.3.3 Elevator Design Reliability

Elevator reliability requirements are based on the following parameters:

- System operating time: 24 hours/day, 7 days/week
- Operating hours per year: 8,760
- Max requirements: 90 percent of full load capacity for peak periods of 3 hour duration, twice per day
- 50 percent of full load capacity during off peak periods
- Service Design Life: 30 years

4.4 Elevator Environmental Requirements

4.4.1 Elevator Cab Temperatures

Elevator cabs shall be equipped with ceiling mounted fans sized appropriately to maintain air flow inside the cab and minimize cab interior temperatures during warmer months.

Advisory Note 4.4.1: Solar load should be considered when sizing the elevator cab cartop mounted fans. Different glazing and additional cab ceiling fans may be needed on elevator cabs that are outside and in direct sunlight.

4.4.2 Exterior Installations

Elevators headhouses and fenestration there of shall be designed by an architect. Those elevator units that open directly to street level or are otherwise exposed to the outdoor environment shall be designed to operate in temperatures ranging from - 25 to 120 degrees F (dry bulb) and all conditions of relative humidity while exposed to airborne dust for Hydraulic elevators. Machine room less elevators shall be designed to operate in temperatures ranging from 35 to 104 degrees F (dry bulb)

Document Title: MBTA Elevator Design Standard	Rev No.: 09 Rev Date: 7/31/2017	Page: 9 of 31
--	--	-------------------------

in the hoistway and - 25 to 120 degrees F (dry bulb) in the controller room.

Exterior installed elevators may be exposed to wind, direct sunlight, rain, snow, sleet, airborne dust or other environmental impact. Elevators exposed to rain, snow whether direct or indirect (pedestrian's clothing, wheels, or umbrellas), shall continue to safely operate and function without interruption of service. Unless physically impossible elevators shall not be designed to have doors open in the predominant direction of known direct wind unless storm rated wind and rain blocks are installed to prevent rain / snow infiltration and flooding situations. In general, headhouse designs for elevators should include generous side wind blocks see advisory note 4.4.2 and include substantial lit overhangs.

Exterior elevator headhouses including louvers, windblocks and canopies shall to the maximum extent feasible be designed for storm resiliency including as guided by federal and state directives. Elevator doorway designs shall provide mechanisms to drop in flood barriers at potential and designated FEMA flooding locations. Electrical and mechanical elements in known or predictable flooding locations shall be located above 300 year FEMA flood zones wherever possible. Machine rooms should be located above the predicted flood plan where possible.

Coordination, where appropriate shall occur with the MassDOT/MBTA Environmental department as well as other entities as directed by the MBTA. The designer shall work with the MBTA to ensure such coordination occurs.

The architect is responsible to ensure that new exterior elevator headhouse locations where surface and adjacent building elevations vary, shall to the extent structurally feasible, interface with adjacent roadway bridges, raised plazas or building entrances, even if this requires a 3rd stop for the elevator. Such design efforts are understood by the MBTA as a method to reduce customer journey distance and or solve adjacent long-standing accessibility problems.

Advisory Note 4.4.2: Prevailing wind direction shall be considered when designing the elevator door location. Doors should not be placed in the direction of the prevailing wind direction unless full wind and rain blocks are integral to the elevator design.

4.4.3 Interior Installations

Hydraulic elevators shall be designed to operate in underground temperatures ranging from -25 to 120 degrees F (dry bulb) and all

Document Title: MBTA Elevator Design Standard	Rev No.: 09 Rev Date: 7/31/2017	Page: 10 of 31
---	------------------------------------	-------------------

conditions of relative humidity while exposed to airborne dust. Machine room less elevators shall be designed to operate in temperatures ranging from 35 to 104 degrees F (dry bulb) in the hoistway and -25 to 120 degrees F (dry bulb) in the controller room.

4.4.4 Elevator Equipment Rooms

Machinery shall be designed to operate in underground temperatures ranging from -25 to 120 degrees F (dry bulb) and all conditions of relative humidity while exposed to airborne dust. Machine rooms shall include systems to maintain machine room temperatures between 50 and 90 degrees F (dry bulb) as per Massachusetts Elevator Regulations 524 CMR. New machine rooms shall not exhaust air to the platform lobby and other public spaces in an effort to avoid heat buildup.

4.4.5 Operating Noise Levels

Steady-state noise produced by elevators or associated equipment (excluding entrance door operations) shall not exceed 65 dBA in public spaces. Noise produced by the operation of the elevator door shall not exceed 65 dBA 3 feet or more from the elevator door inside or outside of the elevator cab.

4.4.6 Seismic Criteria

The elevator equipment shall be designed at a minimal Seismic Zone 2 Classification and in accordance with Seismic Zone requirements determined by the architect and all state and local code requirements if more stringent than Seismic Zone 2 Classification.

4.5 Elevator Cab Configurations

Elevator Cab Configurations and their associative door orientations shall be selected and reviewed for compliance in the order of preference per the sections below. During review, cab configurations and their door opening sizes shall be maximized, where technically and structurally feasible based on station and elevator hoistway constraints. When maximizing door sizes, each elevator cab configuration has limits on maximum achievable door size based on its platform size. These limits shall be reviewed with elevator Original Equipment Manufacturer for compliance. When doors are in the open position, door overhang on elevator cabs shall be avoided, when possible.

For new elevators, **ADA/Stretcher Compliant elevator shall be the default size over ADA compliant.** For both new and existing elevators, pass through cab configurations shall be the preferred configuration for all designs.

Document Title: MBTA Elevator Design Standard	Rev No.: 09 Rev Date: 7/31/2017	Page: 11 of 31
--	------------------------------------	-------------------

If the adjacent stairway does not conform to 780 CMR 8th Edition and 524 CMR Chapter 17 item 17.40 (c), ***elevator stretcher requirements are in effect regardless of the number of stories.***

Please note section 2.0 Scope 1. Exceptions. Cab configurations that deviate from the preferred configuration or size must be disclosed and detailed to MBTA and to the Department of Public Safety as required prior to or part of the 15% design submission.

4.5.1 Cab Orientations

4.5.1.1 Pass Through Cab Configuration (ADA/Stretcher Compliant)

Pass through cab configurations with opening doors opposite each other ***are the preferred configuration for elevators within the MBTA system.*** Specific minimum configuration requirements for pass through cab systems that are required to carry stretchers are:

Minimum Cab Width: 60" (1524 mm) wall to wall

Minimum Cab Depth: 94 ½" (2400.3 mm) door panel to door panel

Total minimum floor space: 39.375 Sq. Ft

Standardized minimum configuration dimensions, including clear hoistway envelopes, for compliance with the above are provided in **Appendix A (Part 1)**. Center opening doors, where used, shall be single speed design.

4.5.1.2 Pass Through Cab Configuration (ADA Compliant)

Pass through cab configurations with opening doors opposite each other ***are the preferred configuration for elevators within the MBTA system.*** Specific minimum configuration requirements for pass through cab systems are:

Minimum Cab Width: 60" (1524 mm) wall to wall

Minimum Cab Depth: 80" (1829 mm) door panel to door panel

Total minimum floor space: 33.33 Sq. Ft.

Standardized minimum configuration dimensions, including clear hoistway envelopes, for compliance with the above are provided in **Appendix A (Part 2)**. Center opening doors, where used, shall be single speed design.

Advisory Note 4.5.1.2.a: It is the intent that stretcher elevators should be used for emergency use. Accordingly standby power from a generator or secondary MBTA power feed must be provided. Standby power shall not be backup batteries or UPS systems.

Advisory Note 4.5.1.2.b: If the adjacent stairway does not conform to 780 CMR Current Edition and 524 CMR Chapter 17 item 17.40 (c), stretcher requirements are in effect regardless of the number of stories.

4.5.1.3 90 Degree Entry Configuration (ADA/Stretcher Compliant)

90 Degree (doors on adjacent elevator sides) cab configurations shall only be used where station structural and egress configurations preclude the use of pass through or single entry cab configurations. Specific minimum configuration requirements for 90 degree entry cab systems that are required to carry stretchers are:

Minimum Cab Width: 70 1/4" (1784 mm) door panel to wall

Minimum Cab Depth: 90 1/4" (2292.3 mm) door panel to wall

Total minimum floor space: 44.02 Sq. Ft.

Standardized minimum configuration dimensions, including clear hoistway envelopes, for compliance with the above are provided in **Appendix A (Part 1)**.

4.5.1.4 90 Degree Entry Configuration (ADA Compliant)

90 Degree (doors on adjacent elevator sides) cab configurations shall only be used where station structural and egress configurations preclude the use of pass through or single entry cab configurations. Specific minimum configuration requirements for 90 degree entry cab systems are:

Minimum Cab Width: 76 1/4" (1936 mm) door panel to wall

Minimum Cab Depth: 76 1/4" (1936 mm) door panel to wall

Total minimum floor space: 40.37 Sq. Ft.

Standardized minimum configuration dimensions, including clear hoistway envelopes, for compliance with the above are provided in **Appendix A (Part 2)**.

4.5.1.5 **Single Entry/Exit Configuration (ADA/Stretcher Compliant)**

Single entry cab configurations are acceptable for use where pass through cab systems cannot be used due to station structural and egress configurations. Specific minimum configuration requirements for single entry cab systems are:

Minimum Cab Width: 60" (1524 mm) wall to wall

Minimum Cab Depth: 90 1/4" (2292.3 mm) door panel to wall

Total minimum floor space: 37.6 Sq. Ft.

Standardized minimum configuration dimensions, including clear hoistway envelopes, for compliance with the above are provided in **Appendix A (Part 1)**. Center opening doors, where used, shall be single speed design.

4.5.1.6 **Single Entry/Exit Configuration (ADA Compliant)**

Single entry cab configurations are acceptable for use where pass through cab systems cannot be used due to station structural and egress configurations. Specific minimum configuration requirements for single entry cab systems are:

Minimum Cab Width: 60" (1524 mm) wall to wall

Minimum Cab Depth: 80" (2032 mm) door panel to wall

Total minimum floor space: 33.33 Sq. Ft.

Standardized minimum configuration dimensions, including clear hoistway envelopes, for compliance with the above are provided in **Appendix A (Part 2)**. Center opening doors, where used, shall be single speed design.

4.5.1.7 **Elevator Cab Floor Space Exception**

If the elevator floor square footage exceeds the minimum as required above and the orientation of the width or depth cannot be met, an alternate dimension may be proposed and used subject to documenting and receiving the written approval of MBTA System-Wide Accessibility, System-Wide Operations Support, and the Capital Delivery Departments. The MBTA

Document Title: MBTA Elevator Design Standard	Rev No.: 09 Rev Date: 7/31/2017	Page: 14 of 31
---	--	--------------------------

acknowledges replacement units may not meet square footage requirements.

4.5.2 Elevator Entrance Doors

The elevator entrance doors shall provide a minimum clear opening width of 42" and height of 84". If the existing hoistway does not allow the minimum width and height due to structural or existing conditions this is subject to MBTA approval.

Cab and hoistway door designs shall maximize visual transparency using safety glass or other transparent material in a manner that reflects current requirements of the referenced state and federal fire and elevator codes. Cab and hoistway door designs shall conform to the details defined in **Appendix E and F Part 1 or 2** of this document.

Full glass entrance doors are not available as a fire rated assembly. If the hoistway must be fire rated per code and a DPS variance was not granted, then vision panels must be incorporated into the door design.

Landing sills shall conform to Rule 2.11 of the ASME A17.1 Code and shall be extruded stainless steel with a mill finish supplied with grooves and trash slots for door guides and machine planed for minimum clearance. Mount sills on combination of concrete/grout and steel supports anchored to floor construction. In addition to the above all exterior sills shall be heat traced. Exterior hoistway and landing sills shall provide mechanisms to drop in flood barriers at potential and designated FEMA flooding locations.

Advisory Note 4.5.2: The door type can make a 6" impact to interior clear space (stacked versus 2 sliders). The MBTA encourages the use of 2 single sliders so as to maximize the interior space even if interior cab space is not an issue.

Advisory Note 4.5.3:

As per IBC-2009

SECTION 2409 GLASS IN ELEVATOR HOISTWAYS AND ELEVATOR CARS

2409.1 Glass in elevator hoistway enclosures. Glass in elevator hoistway enclosures and hoistway doors shall be laminated glass conforming to ANSI Z97.1 or CPSC 16 CFR.

2409.1.1 Fire-resistance-rated hoistways. Glass installed in hoistways and hoistway doors where the hoistway is required to have a fire-resistance rating shall also comply with Section 715 of IBC-2009.

2409.1.2 Glass hoistway doors. The glass in glass hoistway doors shall be not less than 60 percent of the total visible door panel surface area as seen from the landing side.

2409.2 Glass vision panels. Glass in vision panels in elevator hoistway doors shall be permitted to be any transparent glazing material not less than $\frac{1}{4}$ inches (6.4 mm) in thickness conforming to Class A in accordance with ANSI Z97.1 or Category II in accordance with CPSC 16 CFR. The area of any single vision panel shall not be less than 24 square inches (15 484 mm²) and the total area of one or more vision panels in any hoistway door shall be not more than 85 square inches (54 839 mm²).

4.5.3 Elevator Cab Construction

4.5.3.1 Cab Wall Design

Elevator cab walls shall be designed to maximize transparency above the finished floor using safety glass or other transparent material compliant with the referenced Code requirements. Lower glazed panels in the cab walls shall start 12" above finished floor so that the walls are protected.

Elevator cab handrails shall be located between 33 and 36 inches above the floor on all walls without doors. Handrails shall withstand a vertical or horizontal force of 300 pounds, minimum. Handrail design and installation shall comply with the requirements of ADAAG 505.5 through 505.9 as well as all pertinent ANSI/IBC Standard. All handrails shall be mounted using through-bolting and backer plates.

4.5.3.2 Cab Flooring Systems

Elevator sub-flooring system shall be provided in $\frac{1}{4}$ " (6 mm) thick, minimum, Type 316L stainless steel. Sub flooring shall be full width and depth of elevator platform assembly and prepared to accept epoxy flooring finished floor.

Finish flooring shall be poured slip resistant epoxy incorporating a full membrane system for the entire cab floor width and depth. Poured flooring shall be formed to include contiguous 4" minimum coving at all walls with openings formed at the elevator entrances and shall have 4" rolled/cove returns on side walls. Floor to coving transitions shall be formed to produce a one half inch minimum transition radius. Vertical edges at elevator entrances shall be formed with one half inch radii. Floor shall be pitched from the center to prevent fluid accumulation. The epoxy shall have a low VOC, fast cure time, and longevity.

1. Wood or similar materials that have the potential to absorb moisture shall not be used as sub-floor material.

Document Title: MBTA Elevator Design Standard	Rev No.: 09 Rev Date: 7/31/2017	Page: 16 of 31
--	------------------------------------	-------------------

2. Placement of Epoxy may only take place during off hours.
3. Installation of flooring to be installed and warrantied for one (1) year by the flooring manufacturer.
4. Floor covering for elevator cab shall be 1/8" Dur-A-Quartz Q28 Epoxy. Underlayment shall be ELASTOCOAT by DUR-A-FLEX INC. Topcoat shall be Accelerera by DUR-A-FLEX INC.
5. Color to be Dur-a-quartz Q28-21 or approved equal. (Black/Grey/White). Color samples to be submitted by the Contractor to the MBTA and design engineer for approval.

Advisory Note 4.5.3.2.a: To help ensure proper adhesion and bonding between sub-flooring and finish floor, the flooring manufacturer shall be an approved installer per the flooring manufacturer

4.5.3.3 Car Operating Panels

All pass through and 90-degree elevator configurations shall be provided with a primary and a secondary car operating panel located in the reveal covering the elevator door operating mechanism. Car operating panel shall conform to the details defined in **Appendix B (Part 1 and 2)** of this document. Auxiliary car call stations shall be provided on all elevators. Auxiliary car call stations for single entry\exit cab designs shall be located on the rear wall in the opposite corner to the primary car call station at the elevator entry. Locations shall conform to the following:

Pass Through (front and rear) and 90 Degree (front and side) Entry Cab Designs:

- Primary car call station at top landing door entry side.
- Auxiliary car call station on opposite door entry side

Single Entry\Exit (openings in line) Cab Designs

- Primary car call station in door return
- Auxiliary car call station located as shown below.

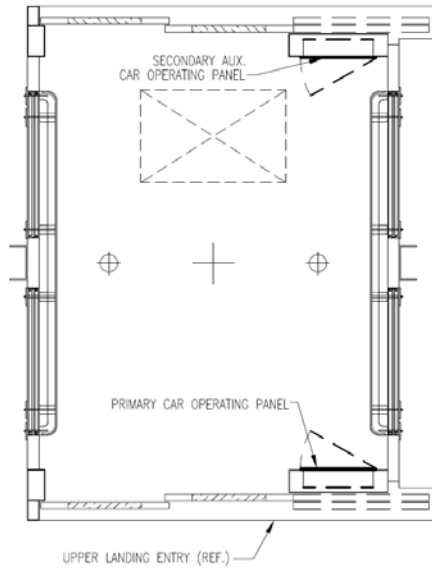

Pass Through Cab
(Two Speed Side Slide Doors)

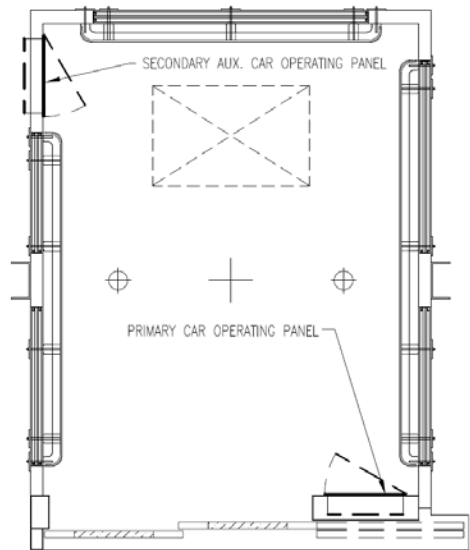

Single Entry/Exit Cab
(Two Speed Side Slide Doors)

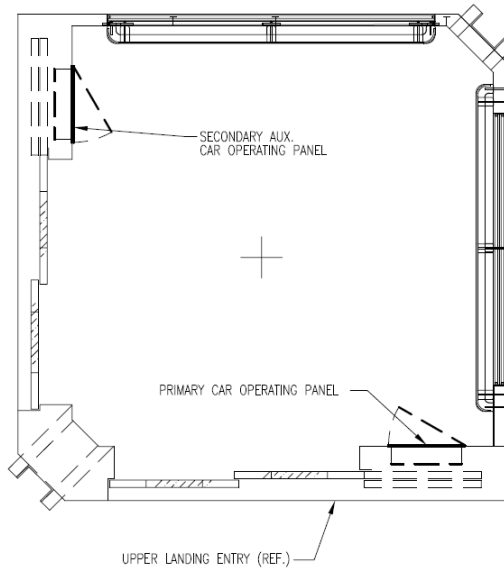

90 Degree Entry/Exit
(Two Speed Side Slide Door)

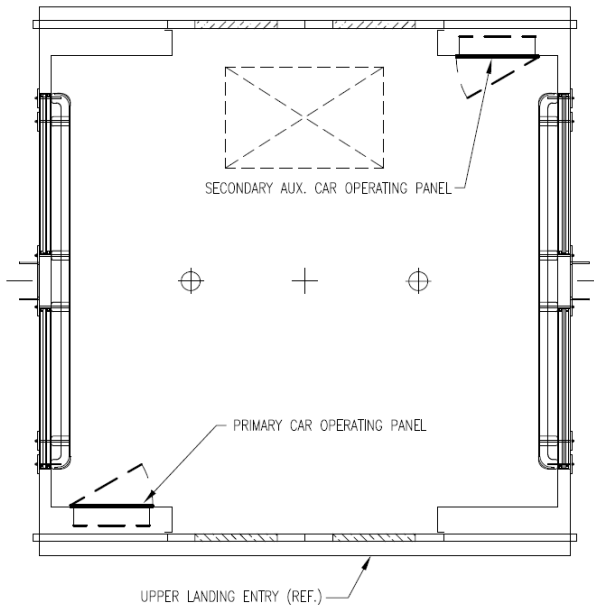

Pass Through Cab
(Single Speed Center Opening Door)

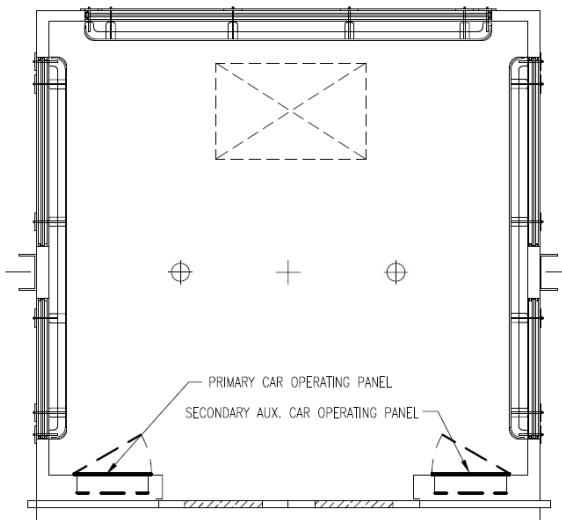

Single Entry/Exit Cab
(Single Speed Center Opening Doors)

Car Operating Panel Locations

4.5.3.4 Cab Station and Hall Call Station Requirements

4.5.3.4.1 All elevator controls, operable parts and functions such as an intercom microphone and actuator button, along with visual indicators, that a passenger needs to interact with shall be mounted within the range of 24" to 48" above the finished floor. All other controls for maintenance and Fire Service Operations in conjunction with speakers may be located above or below the 24"-48" range and in accordance with referenced codes. *No operable parts for the two-way communication including the microphone shall be above the 48" height.*

4.5.3.4.2 On the car operating panels, the main level shall be indicated with the Visual Indicator Star "★". as required per code.

4.5.3.4.3 On the call station, floors shall be labeled as the following until there has been a formal review and written plan approval by System-Wide Accessibility, MBTA Graphics and Wayfinding:

- Street
- Lobby
- Lobby 2 (depending on station type)
- Platform, Commuter Rail or Trains (depending on station type)

In stations with more than five levels or where the car operating panel cannot accommodate full size floor name plates, the floor names shall be abbreviated in an effort to fit adjacent to the appropriate landing button within the car operating panel. See appendix B for reference.

In these cases, floors shall be labeled as the following until there has been a formal review and written plan approval by System-Wide Accessibility:

- S to indicate Street level
- L to indicate Lobby level
- M to indicate Mezzanine level
- P to indicate Platform or Plaza level
- 1 to indicate level one

4.5.3.4.4 Signage related to elevators shall be coordinated with MBTA Graphics and Wayfinding. Elevator related

Document Title: MBTA Elevator Design Standard	Rev No.: 09 Rev Date: 7/31/2017	Page: 20 of 31
--	------------------------------------	-------------------

Signage shall be provided as indicated in Appendix H: Elevator Related Signage Design Requirements.

4.5.3.4.5 Labels shall be provided as required by code as well as the specific MBTA elevator number such as “PARK STREET #804”. Labels shall conform to the following specifications as defined in the latest edition of ADAAG:

Raised Characters. Raised characters shall comply with R409.2 (ADAAG) and shall be duplicated in braille complying with ADAAG. Raised characters shall be installed in accordance with ADAAG.

Depth. Raised characters shall be 0.8 mm (.03 in) minimum above their background.

Case. Characters shall be uppercase.

Style. Characters shall be sans serif. Characters shall not be italic, oblique, script, highly decorative, or of other unusual forms.

Character Proportions. Characters shall be selected from fonts where the width of the uppercase letter O is 55 percent minimum and 110 percent maximum of the height of the uppercase letter in inches.

Character Height. Character height measured vertically from the baseline of the character shall be 16 mm (0.625 in) minimum and 51 mm (2 in) maximum based on the height of the uppercase letter in inches. Where separate raised and visual characters with the same information are provided, raised character height shall be permitted to be 13 mm (0.5 in) minimum.

Stroke Thickness. Stroke thickness of the uppercase letter in inches shall be 15 percent maximum of the height of the character.

Character Spacing. Character spacing shall be measured between the two closest points of adjacent raised characters within a message, excluding word spaces. Where characters have rectangular cross sections, spacing between individual raised characters shall be 3.2 mm (0.125 in) minimum and 4 times the raised character stroke width maximum. Where characters have other cross sections, spacing between individual raised characters shall be 1.6 mm (.625 in) minimum and 4 times the raised character stroke width maximum at the base of the cross sections, and 3.2 mm (0.125 in) minimum and 4 times the raised character stroke width maximum at the top of the cross sections. Characters shall be separated from raised borders and decorative elements 9.5 mm (.375 in) minimum.

Line Spacing. Spacing between the baselines of separate lines of raised characters within a message shall be 135 percent minimum and 170 percent maximum of the raised character height.

Braille. Braille shall be contracted (Grade 2)

Position. Braille shall be positioned above the corresponding text. If text is multi-lined, Braille shall be placed above the entire text. Braille shall be separated 9.5 mm (.375 in) minimum from any other tactile characters and 9.5 mm (.375 in) minimum from raised borders and decorative elements. Braille provided on elevator car controls shall be separated 4.8 mm (.1875 in) minimum and shall be located either directly above or adjacent to the corresponding raised characters or symbols.

Dimensions and Capitalization. Braille dots shall have a domed or rounded shape and shall comply with Table R409.3.1 (ADAAG). The indication of an uppercase letter or letters shall only be used before the first word of sentences, proper nouns and names, individual letters of the alphabet, initials, and acronyms.

Braille Dimensions.

Dot base diameter

1.5 mm (0.059 in) to 1.6 mm (0.063 in)

Distance between two dots in the same cell

2.3 mm (0.090 in) to 2.5 mm (0.100 in)

Distance between corresponding dots in adjacent cells

6.1 mm (0.241 in) to 7.6 mm (0.300 in)

Dot height

0.6 mm (0.025 in) to 0.9 mm (0.037 in)

Distance between corresponding dots from one cell directly below

10 mm (0.395 in) to 10.2 mm (0.400 in)

Document Title: MBTA Elevator Design Standard	Rev No.: 09 Rev Date: 7/31/2017	Page: 22 of 31
---	------------------------------------	-------------------

4.5.3.5 Cab Ceiling and Lighting

Ceiling components and lighting elements shall be located at sufficient height to be difficult to reach easily and shall be difficult to dislodge, insert objects into, or place objects such as trash on top of.

Ceiling systems shall include a dedicated location for the installation of a security camera (refer to Section 10.0 for Security Requirements). Cameras shall be coordinated with lighting fixture locations to ensure lighting system does not interfere with full viewing of the cab interior.

Lighting systems shall provide 50 foot candles of light measured at all points on the cab floor. Lighting housing assemblies shall be recessed above and around the ceiling elements in a manner that the bulbs are not visible to, or reachable by passengers, but can be quickly replaced. Lighting elements shall not be covered by plastic shields unless required and if required, the shields must be cleaned on a weekly basis. To minimize parts, all ceiling lighting fixtures shall be Luminaire Model #RVP 26 PLEL (NYC Housing Authority Grade) as produced by Benfield Electronics with an Advance Electronics Model #ICF-2S13-H1-LD electronic ballast and type # PLC13 lamps for use in cold temperatures. **See Appendix G.**

4.6 Elevator Hoistway Design

4.6.1 Interior Elevator Shafts

Interior elevator shafts shall maximize transparency into the elevator cab.

There shall be direct visual connection between levels within stations. Wayfinding cues shall also be provided. Additionally, where elevators are adjacent to busways, care should be taken to ensure that bus operators and inspectors can see into the shaft and elevator cab from as many directions as possible.

New elevator installations shall be located in prominent, easily seen locations and in a manner that maximizes the visibility of the entrances and exits. New installations shall be in the middle of or adjacent to the predominant pedestrian routes, and as near as possible to the escalators and stairs connecting the same levels without obstructing sightlines and passenger flow. Coordination of shaft location with station passenger flow and egress plans shall be assessed and approved by the MBTA and Department of Public Safety as part of the

Document Title: MBTA Elevator Design Standard	Rev No.: 09 Rev Date: 7/31/2017	Page: 23 of 31
--	--	--------------------------

location selection. Wherever possible, the elevator hoistway locations shall ensure that paths traveled by elevator users are not circular, unnecessarily long, complicated or visually disconnected from other routes.

Visibility into the shaft and cab shall be a priority to enhance wayfinding and increase the safety of the riding public. Visual openings into existing shafts shall be maximized. Accordingly, existing shafts with limited or no visual transparency shall be thoroughly examined by the design team for opportunities to insert visual opening to enhance wayfinding and cab safety where structurally feasible.

4.6.2 Headhouses

Exterior elevator headhouse systems shall incorporate a 60” minimum overhang with lighting and security cameras so that customers are sheltered from the elements and are in a well-lit area as they wait for the elevator. Designs shall also include substantially transparent side protection provisions where the elevator entrances are subject to side blown rain, snow and sleet. Side protection provisions shall extend a minimum of 18” from the finished exterior hoistway wall. The largest size available/permissible should always be provided.

Headhouse structures shall maximize transparency into the shaft or elevator cab such that the occupants are visible from as many directions as possible.

Designs shall incorporate the MBTA T logo on all sides, identity bands, and any other suitable wayfinding cues which are visible from all approachable directions. Graphics shall utilize the MBTA (most current revision) Graphic and Signage Standards and be provided/reviewed by MBTA Graphics and Wayfinding Department.

Hall call stations shall incorporate call buttons that conform to Section 4.5.3.4 on Controls and Buttons. The name of the station/platform accessed by the elevator in raised lettering and Braille shall be provided above the call buttons for all headhouses at all stations. Floor Designations shall be located to the left of the call button. Call stations and identification shall conform to the details presented in **Appendix C (Part 1, 2 and 3)**.

4.7 Elevator Machine\Equipment Room Design

Machinery and equipment rooms shall include systems to maintain the room temperature between 50 to 90 degrees F (dry bulb) per MA 524 CMR requirements and all conditions of relative humidity while exposed to airborne dust.

Document Title: MBTA Elevator Design Standard	Rev No.: 09 Rev Date: 7/31/2017	Page: 24 of 31
--	------------------------------------	-------------------

5.0 Architectural Design Requirements

Provide an elevator shaft enclosure, consisting primarily of transparent glass panel walls, to provide as much visibility into the elevator as possible. Shaft wall panels shall be marked and identifiable in accordance with ASEM A17.1. Locations shall be clearly identified for Hall Call Elevator Pushbutton Stations and Digital Sign Boards utilized for Wayfinding shall be easily identified and accessible on or around the elevator entrance.

Shaft structural and glazing elements shall be located on top of a concrete pedestal or similar, not less than 12" above finished floor to minimize impacts of salt corrosion as well as collisions with vehicles. In potential and designated FEMA flooding locations, the pedestal may be raised up to 36" above finished floor.

Provide standard MBTA headhouse designs for installations where elevator shafts penetrate streets. Headhouse designs shall conform to the requirements of 4.6.2 of this document. Bollards and other defensive elements shall be provided around elevator headhouses and shafts in locations directly or within relative distance to streets or where vehicle movement is in close proximity.

At locations exposed directly or within a reasonable distance to the ocean and/or other large bodies of water, headhouse design shall include roll shutters or similar hurricane protection. Design shall coordinate with MBTA Engineering & Maintenance as well as Environmental departments.

Machine rooms should be located above the predicted flood plan where possible.

Provide ADA accessible paths, not less than 5'-0" wide and with not less than 1:50 cross-slope, to and from the elevators for all new station designs, the installation of new elevators into existing stations, and where existing elevators are replaced.

At each floor that the elevator serves, a 5'-0" long level landing with a 1:50 cross-slope for the width of the elevator shaft shall be provided.

Provide hoistway and machine room ventilation conforming to the requirements of MA 524 CMR, 780 CMR, and all other applicable codes. New machine rooms shall not exhaust air to the platform lobby and other public spaces in an effort to avoid heat buildup.

New station designs, or major station reconstruction efforts, shall include provisions to ensure that all train platforms include accessible paths with elevators as required. Designs shall also include redundancy such that the failure, or removal from service, of any single elevator shall not result in the loss of accessible paths for the system.

Lobbies with benches, planters, garbage cans and other items near the hall stations should be modified to maintain clear floor space. According to ADA 2010, **Advisory section no. 407.2.1.3 Clear Floor or Ground Space**, the clear floor or ground space required at elevator call buttons must remain free of obstructions including ashtrays, plants, and other decorative elements that prevent wheelchair users and

Document Title: MBTA Elevator Design Standard	Rev No.: 09 Rev Date: 7/31/2017	Page: 25 of 31
--	--	--------------------------

others from reaching the call buttons. Height of the clear floor or ground space is considered to be a volume from the floor to 80 inches (2030 mm) above the floor.

Provide Class ABC Fire Extinguishers in elevator electrical machinery and control spaces in accordance with MA CMR 524.

5.1 Advertising

Special care shall be utilized when incorporating marketing into an elevator, hoistway, and/or headhouse. Advertisements shall not block the glazing of the hoistway, be added to cab flooring or impede any functions of the elevator. Marketing if provided shall not obstruct, crowd, or disrupt MBTA Wayfinding signage and all T logos. The MBTA Customer Experience Department shall be contacted during design to assess requirements and incorporate those through design.

6.0 Civil/Structural Design Requirements

Provide required excavation plans for new structures and/or installation of new elevator hoistways. Provide structural reinforcing, as required, for installation of new elevator hoistways which penetrate existing station walls, platforms or ceilings and in conditions where existing station structural elements such as beams and girders, might have to be modified if they impede installation of the new elevator hoistway.

Provide designs of new steel and/or concrete required for new elevator shafts and, if applicable, elevator machine rooms.

Provide access ladder into elevator pits in compliance with ASME A17.1 and MA 524 and 780 CMR requirements.

Provide 2 ft by 2 ft by 2 ft sump where permissible or possible in elevator pits coordinated with elevator system design and backup power for the pumps to ensure continuous discharge. Oil/Water separators shall be provided as required by plumbing code and where directed by the MBTA Engineering & Maintenance as well as Environmental departments.

Design the areas around all elevator entrances inside stations to slope away from the elevator sills. Elevator entrances exposed to the outdoors shall be graded so that rainwater shall not enter the elevator shaft.

7.0 Mechanical Design Requirements

7.1 Heating and Ventilation

Provide thermostatically controlled exhausted fans to ventilate elevator machine rooms. Exhaust fan capacity shall be sized based on the heat output of the elevator power unit assuming 120 complete cycles per hour, or

Document Title: MBTA Elevator Design Standard	Rev No.: 09 Rev Date: 7/31/2017	Page: 26 of 31
---	------------------------------------	-------------------

maximum obtainable, and a 10 degree Fahrenheit difference in the machine room and ambient temperatures. Exhaust fans shall be interlocked with the machine room smoke detectors to shut of in the event of smoke detection. Design of the ventilation system shall conform to the requirements of MA 524 CMR and MA 780 CMR.

Provide one wall mounted thermostatically controlled unit heater per elevator machine room. Unit heater shall be 2.6kW, 208 VAC, single phase, or 480 VAC as a minimum requirement.

7.2 Drainage

7.2.1 Provide drainage for all elevator pits. Gravity drainage shall be provided when possible. Drainage shall be in accordance with ASME A17.1 and MA 524 CMR, and MA 248 CMR 10.0.

7.2.2 Pump(s) shall have backup power (minimum 2 hours).

7.2.3 Oil/water separators shall be provided as required by plumbing code and where directed by the MBTA Engineering & Maintenance as well as Environmental departments.

8.0 Electrical Design Requirements

Provide standard and stand-by auxiliary elevator power for the elevators in accordance with MBTA Electrical Power, Lighting and Controls Engineering requirements. Each elevator machine room shall be provided with a fused (per MA 524 CMR) elevator disconnect. The elevator disconnect switch shall be provided with an electrical interlock kit, containing both a normally open (N.O.) and a normally closed (N.C.) contact, for connection into the elevators automatic lowering device.

Stand-by elevator power shall provide at least the minimum time required by all applicable codes and no less than 1 hour.

A separate cab lighting disconnect shall be provided in the machinery room.

An auxiliary (or ancillary) panel in the machinery room provide a disconnecting means for other auxiliary electrical equipment related to the elevator only such as sill heaters, oil coolers, tank heaters located within the elevator machinery room and hoistway. No equipment, conduit, or wiring shall be located in the elevator shafts or machine room that is not specifically dedicated to the operation of the elevator.

Provide a minimum of two lighting fixtures per elevator pit. Locate the switch adjacent to the elevator pit ladder or other entrance, as applicable, and in accordance with ASME A17.1 and MA 524 CMR requirements.

Document Title: MBTA Elevator Design Standard	Rev No.: 09 Rev Date: 7/31/2017	Page: 27 of 31
--	--	--------------------------

Provide machine room lighting consisting of a minimum of two light fixtures, emergency lighting and at least one duplex GFCI receptacle. Primary machine room lighting shall be designed to produce a minimum of 50 foot candles light at all electronic switch gear, distribution panels, elevator drive machinery and the elevator controller.

Provide one duplex GFCI outlet in the elevator pit for maintenance personnel use. Provide a separate, dedicated, single non-GFCI outlet for sump pump operation when included.

Provide separate circuits in the lighting panel for elevator pit lights.

Provide battery backup for cab fan and as required by MA 524 CMR.

Provide heat tracing for elevator hydraulic oil lines when oil lines are run exposed to the outdoors.

Provide heat tracing for all elevator entry sills for all system types.

Provide battery backup for elevator to go to nearest landing and open doors in the event of power loss.

Provide standby backup power for elevator operation during main power loss.

Low Smoke Zero Halogen (LSZH) covered Liquitite Flexible Metal Conduit shall be utilized. No PVC conduits or PVC coated flexible Liquitite metal conduit shall be allowed.

9.0 Communications Design Requirements

The elevator control equipment shall have remote control capabilities for both emergency and routine operation. Remote control shall originate from the MBTA operations control center at 45 High Street and the Cabot Backup Control Center facilities. Elevator Monitoring and Control System shall be included with the following requirements:

- Monitoring of Elevator System Operational Status and fault Conditions.
- A common set of fault, traffic, and operating data, measured and displayed the same way for all monitored elevators.
- Automatic e-mails when faults occur while recording date, time, duration and type of fault.
- Real time performance of door open and door close functions while the elevator is operation.
- Remote video surveillance of cab entrances and interiors via the network.
- All wiring, switches and other necessary equipment as well as their installation locations shall be reviewed and signed off by the MBTA

Document Title: MBTA Elevator Design Standard	Rev No.: 09 Rev Date: 7/31/2017	Page: 28 of 31
---	------------------------------------	-------------------

Communications and Operations Support Department during both design and construction phases.

Provide telephone terminal box (TTB) in each of the machinery rooms and a cable connection from each TTB to the main termination facility at the station.

Provide a telephone with associated wiring, 12 pair cable, and connect to the existing station telephone system.

Provide an intercom system, along with visual indicators, in compliance with ADA, MAAB, and MBTA requirements. The elevator car control panel shall be provided with speakerphones which connect directly to MBTA Operations Control Center at 45 High Street and to the Cabot Backup Control Center facilities when operated. The intercom button to operate the microphone shall be placed at or below 48" from the finished floor. The microphone shall not exceed 48" above the finished floor. Please see **Appendix B** for illustration. In addition, the elevator machinery room shall be provided with a phone with the ability to call the cab or the MBTA Operations Control Center at 45 High Street and to the Cabot Backup Control Center facilities. The hall call station no longer contains an emergency intercom system. A separate emergency call box unit shall be provided near each elevator entrance. See Appendix H: Elevator Related Signage Design Requirements for details.

Provide each elevator with a sound powered telephone system located in the elevator controller, on top of the elevator cab, and in the elevator cab. Provide three handsets in the storage cabinet in the elevator machine room.

Provide a fire detection system that consists of smoke detectors on each landing level (except at outdoor or ambient weather locations that shall be provided with a heat detector, as required by code) and the elevator machine room. Horns\strokes shall be provided at all landings where one is not already installed in close proximity to the elevator and in the elevator machine rooms when activation of the landing horn\strokes will likely not alert personnel in the elevator machine room. The Fire Alarm Control Panel shall be connected to the elevator controller to provide Fireman's Phase I service. Machine room smoke detectors shall deactivate the machine room exhaust fan.

Provide Elevator Cab Digitized Floor Annunciator to provide a verbal announcement of the arrival to each floor to the passengers. Each floor announcement will coincide with the floor designation listed on the car in print and Braille. For example if floor is listed as Mezzanine, the announcement would state *Mezzanine*. The Elevator cab digitized floor annunciator shall be tamper resistant and enclosed in a NEMA 4X enclosure and inconspicuously mounted in the car top/canopy above the drop ceiling. Faceplate to be Type 316L #4 finish stainless steel. Annunciator shall have the following features:

- a. custom vocabulary
- b. up to 1 Min. of Speech

Document Title: MBTA Elevator Design Standard	Rev No.: 09 Rev Date: 7/31/2017	Page: 29 of 31
--	--	--------------------------

- c. 63 Messages programmability
- d. Up to 3 Output control lines
- e. Human voice programmability via .WAV file types or approved equal
- f. Male and Female Voices
- g. 6-150VAC/DC Inputs
- h. Sealed Mid-Range Speaker
- i. Device shall be connected to the PLC and shall be remotely programmable over the PLC WAN connection

10.0 Security Requirements

Provide Closed Circuit Television System (CCTV) security cameras located inside each car and at each lobby level. Security Camera shall coordinate with the existing CCTV system as required in MBTA specification 16840 Closed Circuit Television System. This specification is maintained and controlled by MBTA Security and Safety Departments to ensure network interoperability.

Inside each car the cab ceiling shall be designed to accept a Network camera outdoor-ready, day/night fixed dome, corner-mount no-grip camera as required in MBTA specification 16840 Closed Circuit Television System. This specification is maintained and controlled by MBTA Security and Safety Departments to ensure network interoperability.

Provide proximity card reader access in addition to a locked key access to elevator machine/control rooms. Proximity card reader access shall be as specified in MBTA specification No. 13700 Access Control System.

11.0 Utility Requirements

Relocate utilities as required to provide space needed for new elevator shafts and/or machine rooms. Utility relocations shall anticipate future elevator and escalator replacements as well as any other known MBTA project within the immediate vicinity and path(s) of utilities.

12.0 Signage and Wayfinding Requirements

Provide required signage and graphics for passenger information in accordance with MBTA Elevator Design Standards, Appendix H: Elevator Related Signage Requirements, current edition of the MBTA Graphics Standards, Massachusetts Architectural Access Board (MAAB) and ADAAG requirements. Includes MBTA specifications:

Document Title: MBTA Elevator Design Standard	Rev No.: 09 Rev Date: 7/31/2017	Page: 30 of 31
---	------------------------------------	-------------------

- 10400 - Fixed Signage
- 10424 - Specialty Signage
- 10426 – Tactile/Braille Signage

The designer of record is expected to coordinate all signage with and seek approval from the MBTA Graphics and Wayfinding. Provide an Elevator “Out of Service” sign and other elevator related signage in accordance with the Appendix H: Elevator Related Signage Design Requirements and current edition of the MBTA Graphics Standard.

Provide a graphic depiction of the cab and station floor plans shall be provided adjacent to the elevator hall call station to aide customers in orientation within stations. See Appendix H: Elevator Related Signage Requirements.

13.0 Turnover Requirements

13.1 Acceptance

All acceptance tests must be completed as specified in technical specifications. A review of materials, specifications, drawings and progress will be held between the MBTA, Designer, and the contractor. Any outstanding items will be recorded and dates will be established for resolution of these items. The DPS acceptance testing and inspection will not be scheduled until resolution of all items.

13.2 Interim Turnover

Interim Turnover will be conducted 60 days (or a mutually agreed upon time-frame) prior to the end of the warranty period. A review of materials, specifications, drawings and progress will be held between the MBTA and the contractor. Any outstanding items will be recorded, and dates will be established for resolution of these items. The final turnover testing will not be scheduled until resolution of all items.

13.3 Final Turnover

24 Hour Final turnover testing shall be completed 30 days prior to the completion of the warranty period. Final Turnover will be conducted through a joint walk thru between the MBTA, the Vertical Transportation Officer, and as requested the MBTA’s elevator maintenance contractor and the contractor prior to the end of the warranty period. Any outstanding items found during the walk thru will be recorded as exceptions, and dates will be established for resolution of these items. The elevator will not be accepted by the MBTA until

Document Title: MBTA Elevator Design Standard	Rev No.: 09 Rev Date: 7/31/2017	Page: 31 of 31
---	--	--------------------------

resolution of all items. All remaining documentation will be transmitted to the MBTA at final turnover. This documentation will be reviewed for completeness, and any discrepancies must be rectified prior to final acceptance. Specific job related requirements for acceptance and final turnover can be found in the Elevator specifications.

Document Title: MBTA Elevator Design Standard	Rev No.: 09 Rev Date: 7/31/2017	Page: A 1 of 41
--	------------------------------------	--------------------

APPENDIX A (Part 1)– Minimum Elevator Configuration Dimensions for ADA and Stretcher Compliancy

9th Edition Advisory Note Appendix A Part 1- ADA/ Stretcher Compliant Elevators: The graphics below are representative of elevators that are ADA compliant and will accommodate stretchers.

As per IBC-2009 Chapter 30- Where elevators are provided in buildings four or more *stories* above, or four or more *stories* below, *grade plane*, at least one elevator shall be provided for fire department emergency access to all floors. The elevator car shall be of such a size and arrangement to accommodate an ambulance stretcher 24 inches by 84 inches (610 mm by 2134 mm) with not less than 5-inch (127 mm) radius corners, in the horizontal, open position and shall be identified by the international symbol for emergency medical services (star of life). The symbol shall not be less than 3 inches (76 mm) high and shall be placed inside on both sides of the hoistway door frame.

As per 780 CMR 8th Edition Chapter 30 and 524 CMR Chapter 17-

17.40: Medical Emergency

Medical Emergency Elevators.

(a) All new buildings, or complete new additions to existing buildings in which an elevator is being installed, and for which building permits were issued on or after **January 1, 2010** shall be provided with at least one passenger elevator designed to accommodate the loading and transportation of an ambulance gurney or stretcher (24" wide by 84" long with 5" radius (corners) in its horizontal position.

EXCEPTIONS: The following elevator installations need not comply with 524 CMR 17.40:

(a) Elevators in structures such as rock quarries, steel towers, dams, storage bins, smoke stacks, tanks (and other special industrial installations) where the elevators are used only by maintenance and operating personnel or in hospitals where the normal services of an EMT are available.

(b) Elevators in buildings or structures where each landing is at ground level or is accessible to ground by a ramp. .

(c) Elevators in buildings or structures equipped with stairs that extend no more than one floor above or below the building entrance grade and with a configuration that shall accommodate the carrying of a gurney or stretcher on said stair and when said stair conforms to 780 CMR *et seq.* (the Massachusetts State Building Code) and is permitted by the authority having jurisdiction.

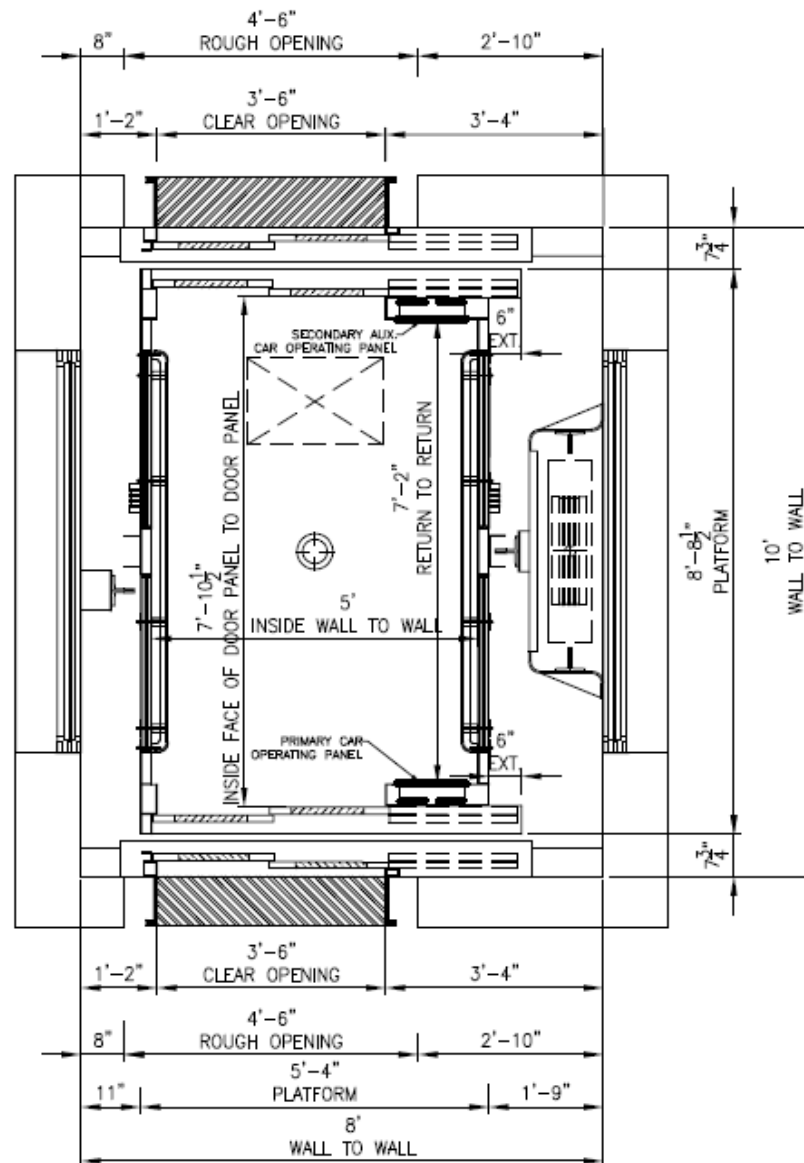
Machine Room Less (MRL):

**MRL Pass-through Design Dimensions
(Two Speed Side Slide Doors)**

Minimum Cab Width: 60" (1524 mm) wall to wall

Minimum Cab Depth: 94 1/2" (2400.3 mm) door panel to door panel

Above design dimensions are representative of APTA Guidelines and Seismic Zone 2 (i.e. IBC Class B or greater) loading/rating requirements.

Above dimensions do not compensate for conditions when there is occupied space below the elevator pit and counterweight safeties are required. Coordination is required with all elevator manufacturers on counterweight safety requirements and any potential increase to 1'-9" dimension.

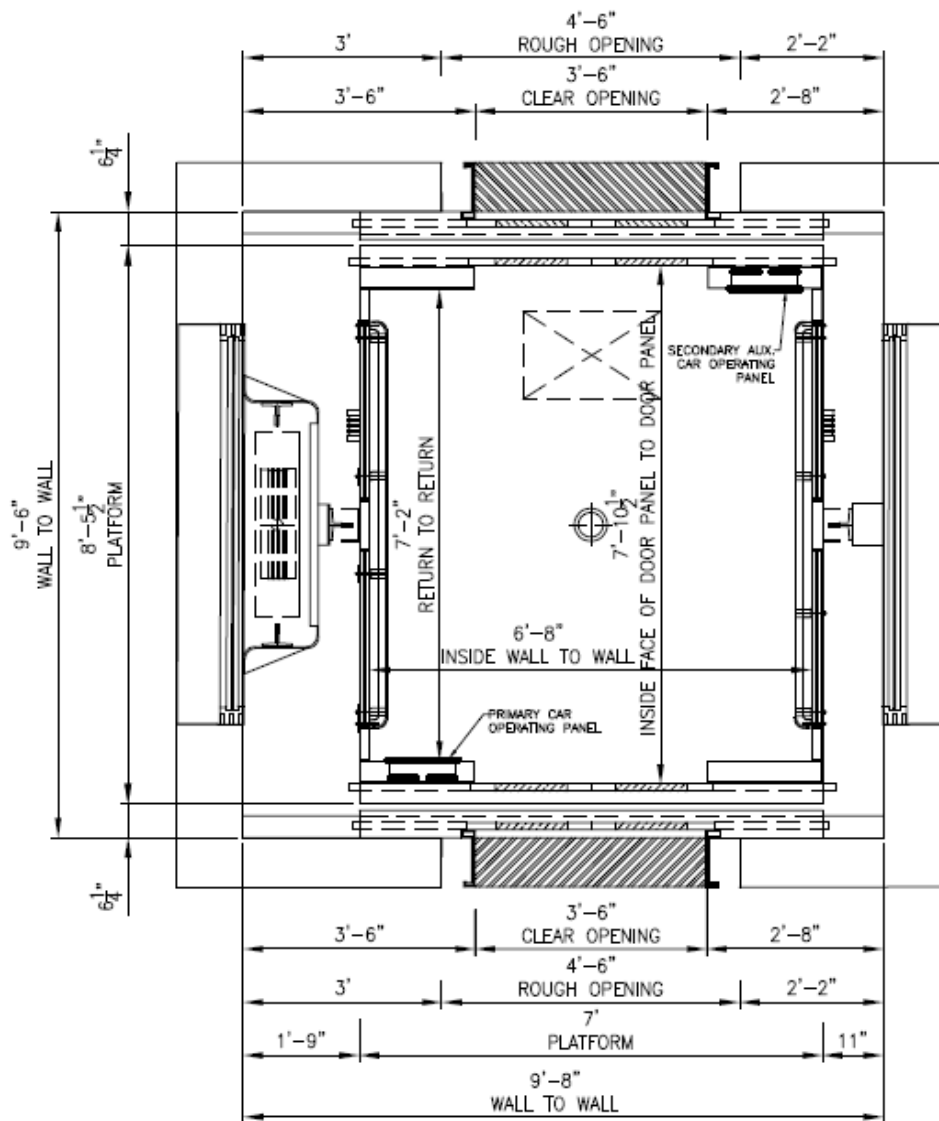

**MRL Pass-through Design Dimensions
(Single Speed Center Opening Doors)**

Minimum Cab Width: 80" (2032 mm) wall to wall

Minimum Cab Depth: 94 1/2" (2400.3 mm) door panel to door panel

Above design dimensions are representative of APTA Guidelines and Seismic Zone 2 (i.e. IBC Class B or greater) loading/rating requirements.

Above dimensions do not compensate for conditions when there is occupied space below the elevator pit and counterweight safeties are required. Coordination is required with all elevator manufacturers on counterweight safety requirements and any potential increase to 1'-9" dimension.

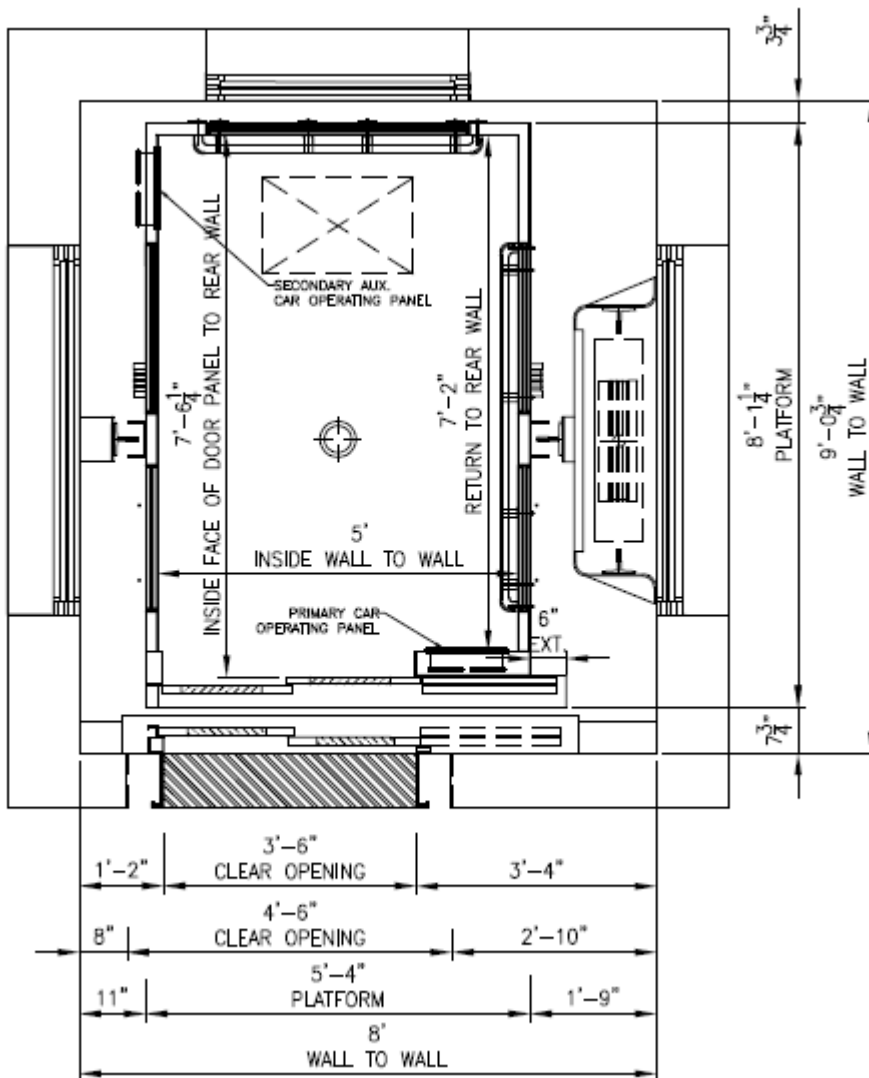

**MRL Single Entry Design Dimensions
(Two Speed Side Slide Door)**

Minimum Cab Width: 60" (1524 mm) wall to wall

Minimum Cab Depth: 90 1/4" (2292.3 mm) door panel to wall

Above design dimensions are representative of APTA Guidelines and Seismic Zone 2 (i.e. IBC Class B or greater) loading/rating requirements.

Above dimensions do not compensate for conditions when there is occupied space below the elevator pit and counterweight safeties are required. Coordination is required with all elevator manufacturers on counterweight safety requirements and any potential increase to 1'-9" dimension.

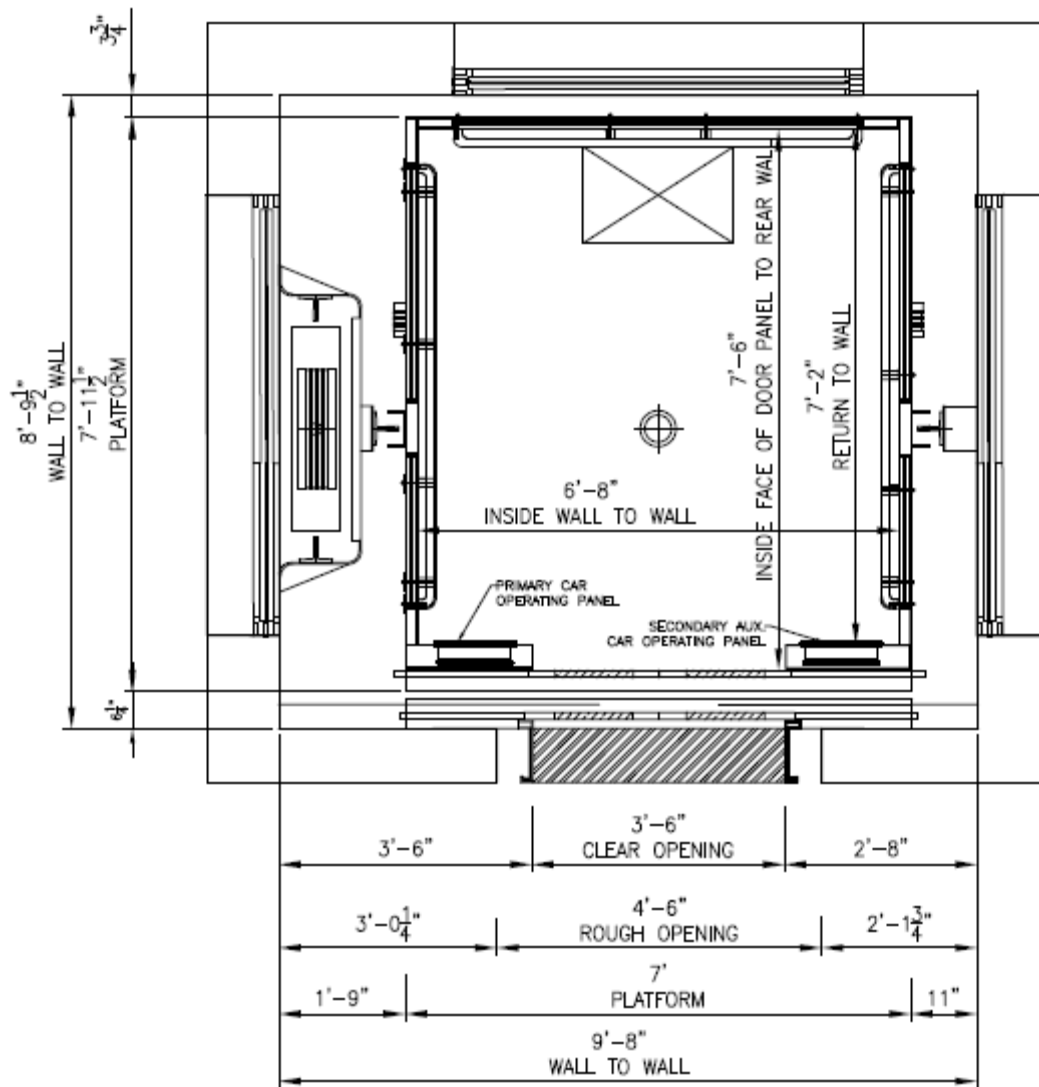

**MRL Single Entry Design Dimensions
(Single Speed Center Opening Door)**

Minimum Cab Width: 80" (2032 mm) wall to wall

Minimum Cab Depth: 90" (2286 mm) door panel to wall

Above design dimensions are representative of APTA Guidelines and Seismic Zone 2 (i.e. IBC Class B or greater) loading/rating requirements.

Above dimensions do not compensate for conditions when there is occupied space below the elevator pit and counterweight safeties are required. Coordination is required with all elevator manufacturers on counterweight safety requirements and any potential increase to 1'-9" dimension.

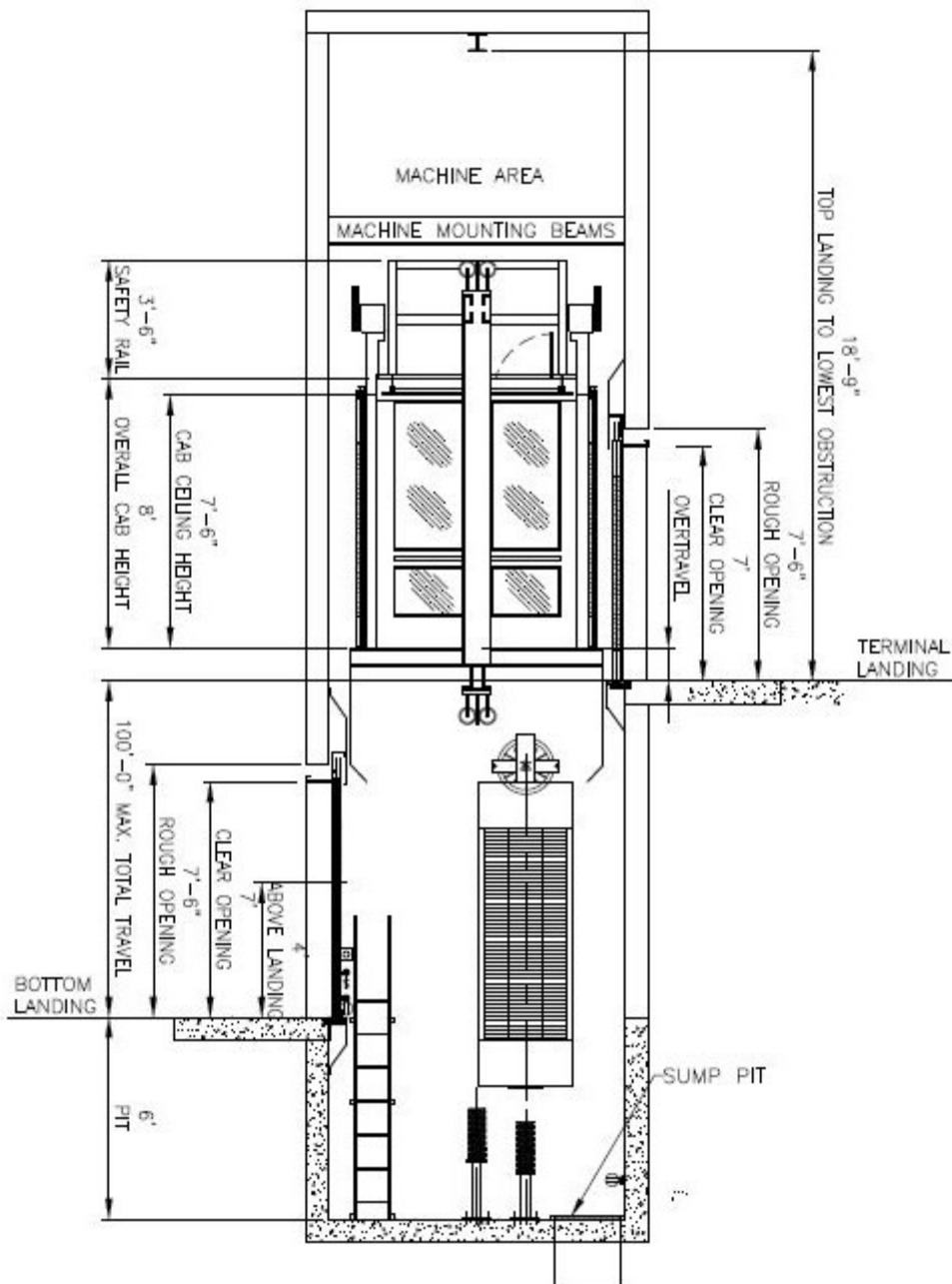

**MRL Section Thru Hoistway Design Dimensions
 (Pass-through Configuration w/ Two Speed Doors)**

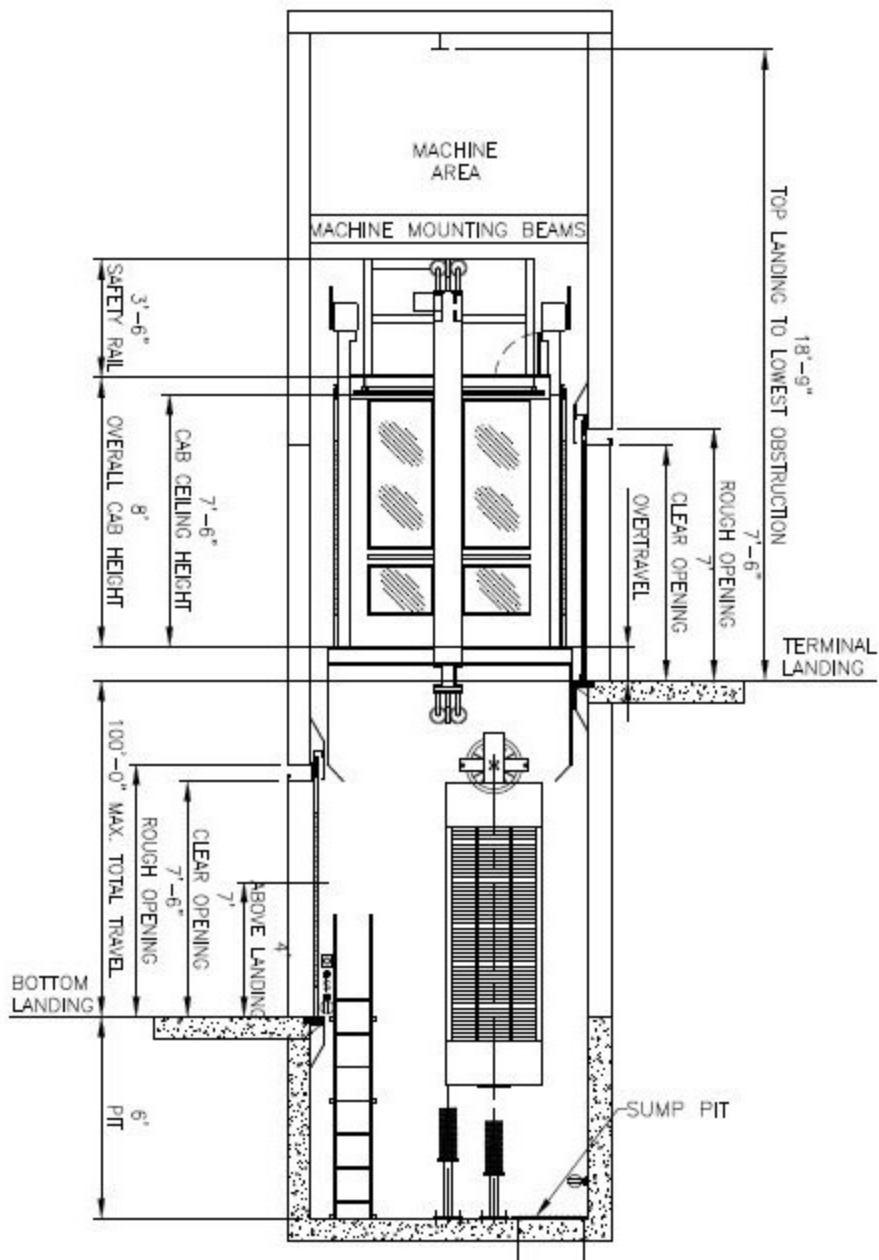

**MRL Section Thru Hoistway Design Dimensions
(Pass-through Configuration w/ Single Speed Center Opening Doors)**

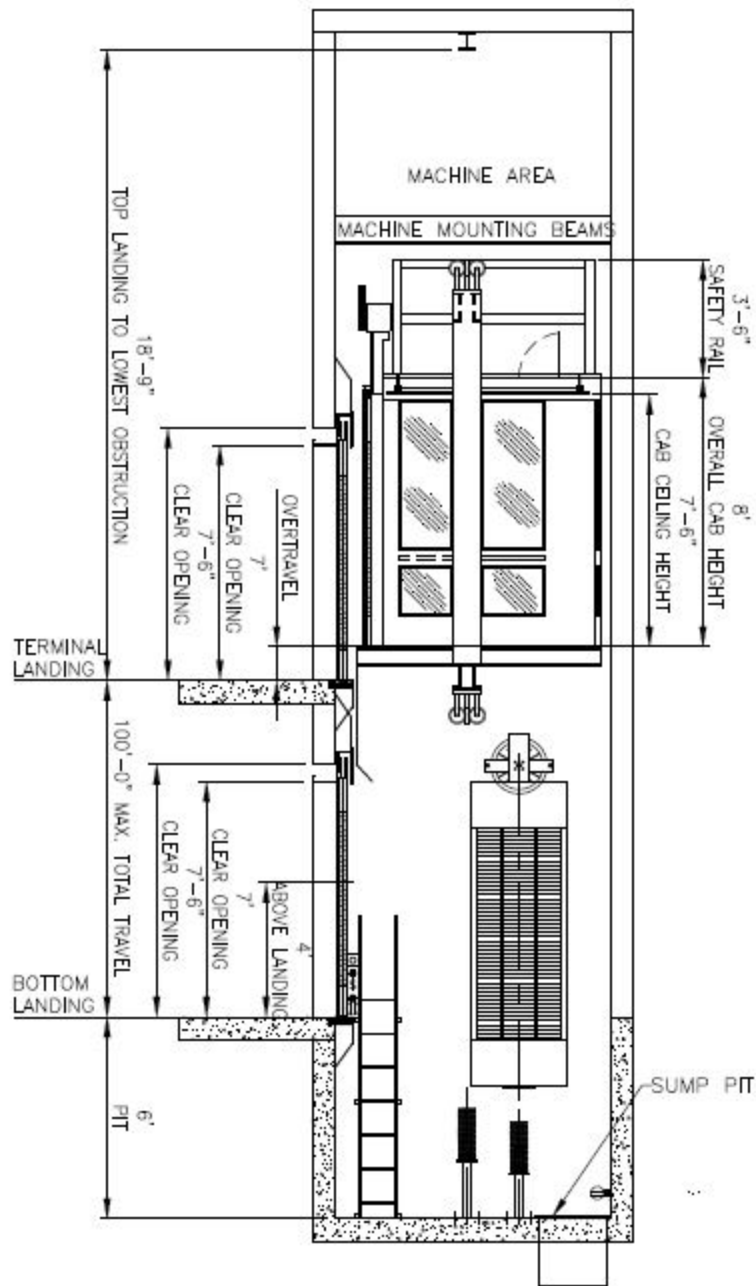

**MRL Section Thru Hoistway Design Dimensions
(Single Entry Configuration w/ Two Speed Doors)**

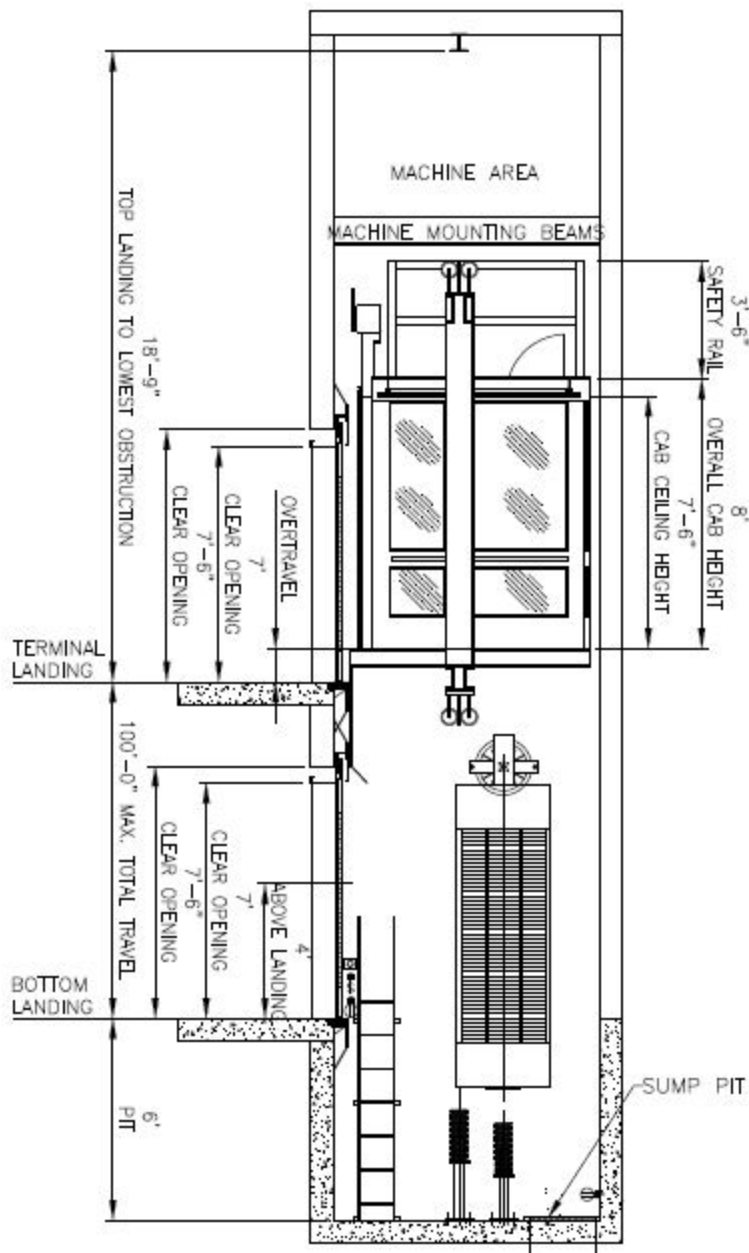

**MRL Section Thru Hoistway Design Dimensions
(Single Entry Configuration w/ Single Speed Center Opening Doors)**

Direct Acting Inground Hydraulic:

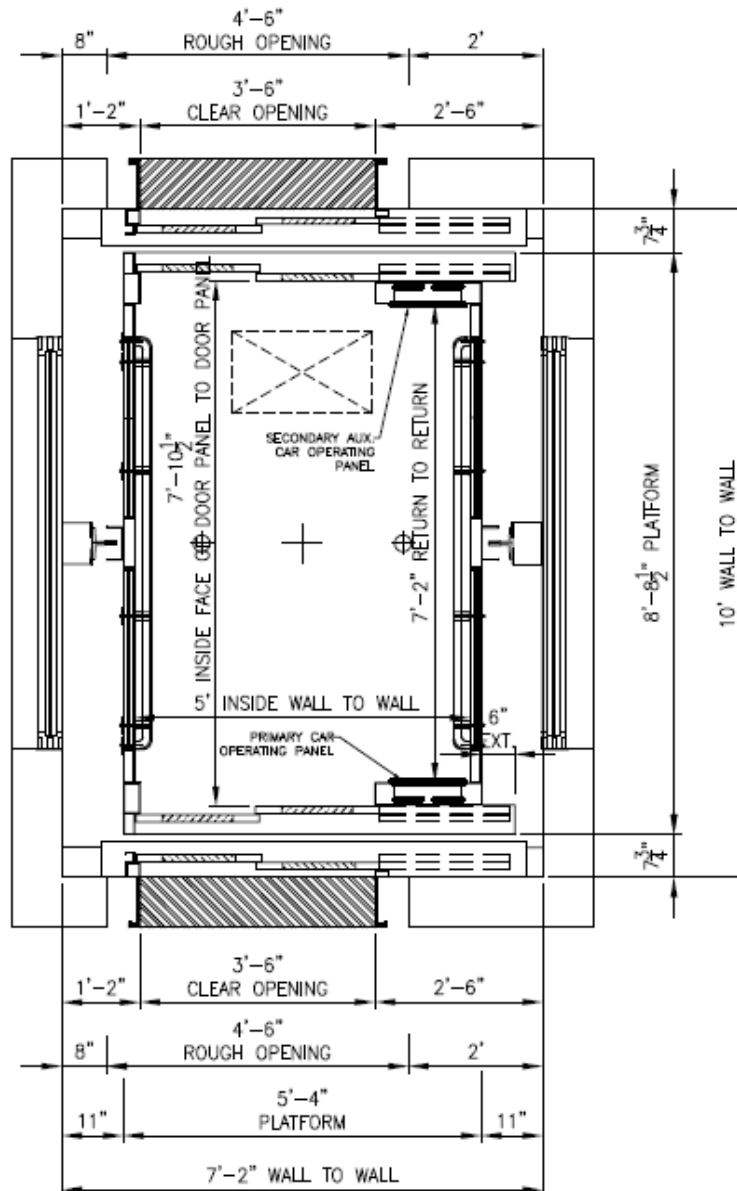

**Direct Acting Inground Hydraulic Pass-through Design Dimensions
(Two Speed Side Slide Doors)**

Minimum Cab Width: 60" (1524 mm) wall to wall

Minimum Cab Depth: 94 1/2" (2400.3 mm) door panel to door panel

Above design dimensions are representative of APTA Guidelines and Seismic Zone 2 (i.e. IBC Class B or greater) loading/rating requirements.

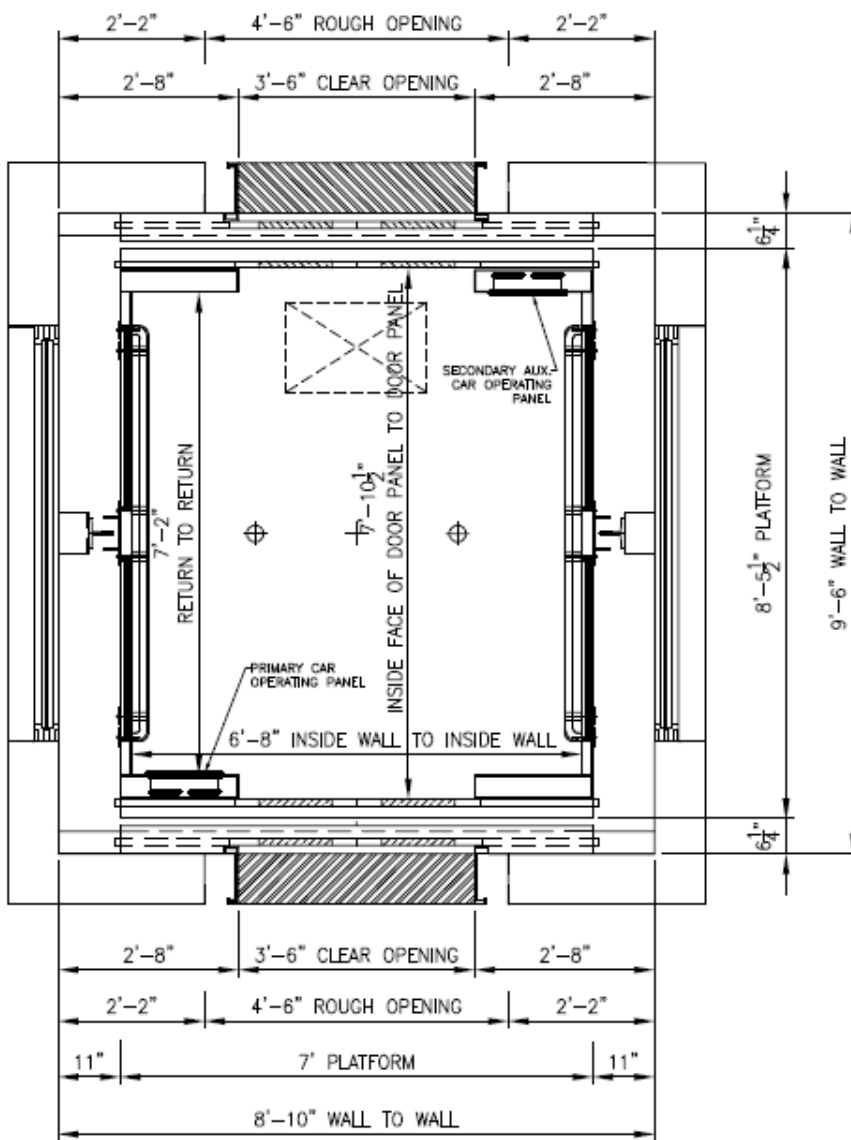

**Direct Acting Inground Hydraulic Pass-through Design Dimensions
 (Single Speed Center Opening Doors)**

Minimum Cab Width: 80" (2032 mm) wall to wall

Minimum Cab Depth: 94 1/2" (2400.3 mm) door panel to door panel

Above design dimensions are representative of APTA Guidelines and Seismic Zone 2 (i.e. IBC Class B or greater) loading/rating requirements.

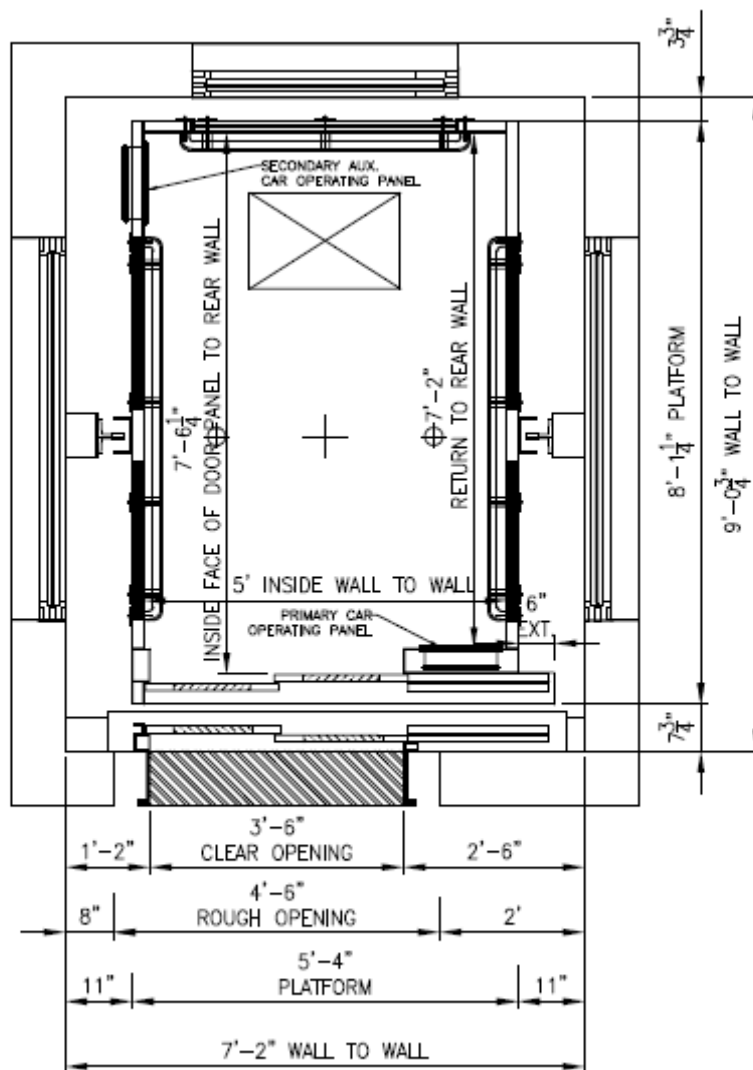

**Direct Acting Inground Hydraulic Single Entry Design Dimensions
(Two Speed Side Slide Door)**

Minimum Cab Width: 60" (1524 mm) wall to wall

Minimum Cab Depth: 90 1/4" (2292.3 mm) door panel to wall

Above design dimensions are representative of APTA Guidelines and Seismic Zone 2 (i.e. IBC Class B or greater) loading/rating requirements.

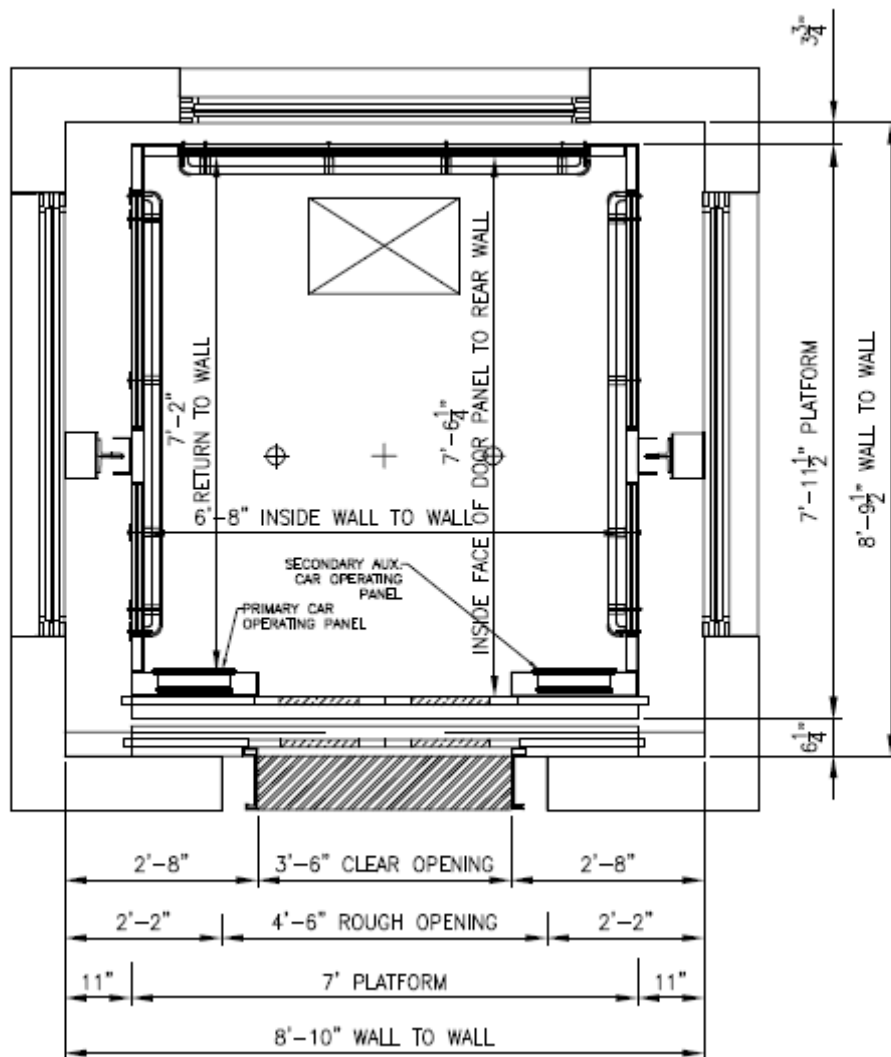

**Direct Acting Inground Hydraulic Single Entry Design Dimensions
 (Single Speed Center Opening Door)**

Minimum Cab Width: 80" (2032 mm) wall to wall

Minimum Cab Depth: 90 1/4" (2292.3 mm) door panel to wall

Above design dimensions are representative of APTA Guidelines and Seismic Zone 2 (i.e. IBC Class B or greater) loading/rating requirements.

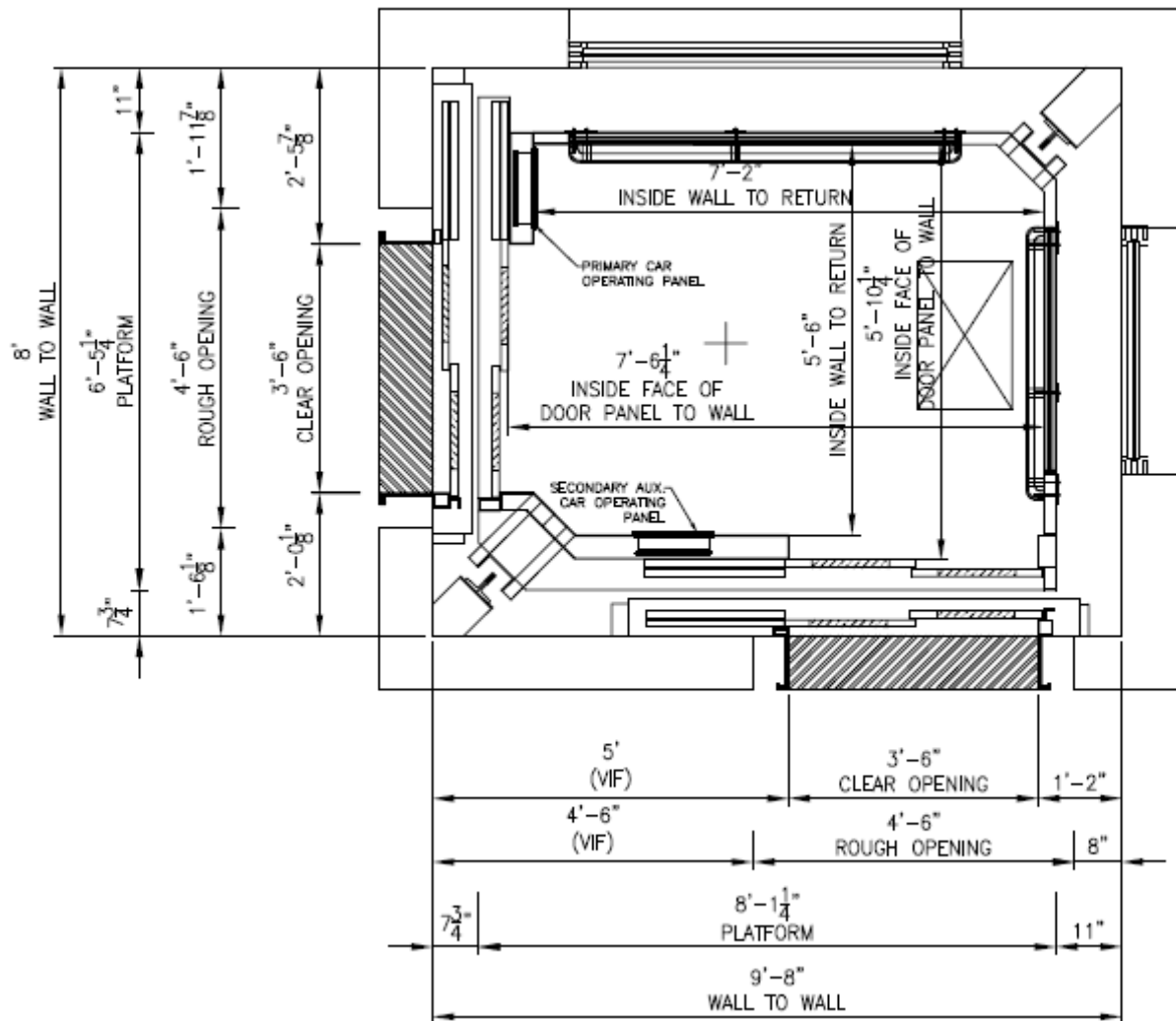

**Direct Acting Inground Hydraulic 90-Degree Design Dimensions
(Two Speed Side Slide Doors)**

Minimum Cab Width: 66" (1828 mm) return to wall

Minimum Cab Depth: 86" (1828 mm) return to wall

Above design dimensions are representative of APTA Guidelines and Seismic Zone 2 (i.e. IBC Class B or greater) loading/rating requirements.

Elevator sill to platform reference dimension (i.e. 7 3/4") shall remain constant.

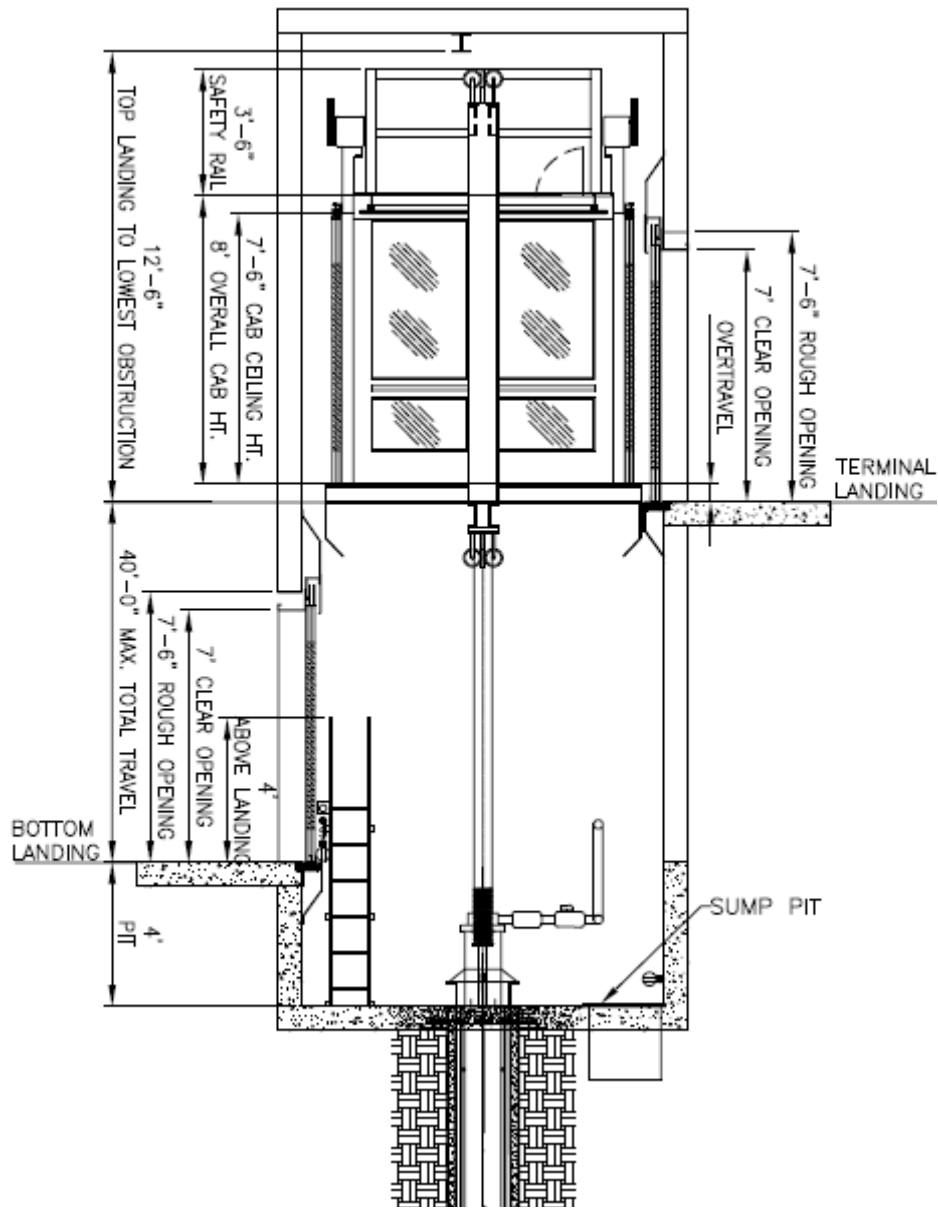

**Direct Acting Inground Hydraulic Section Thru Hoistway Design Dimensions
(Pass through Entry Configuration w/ Two Speed Doors)**

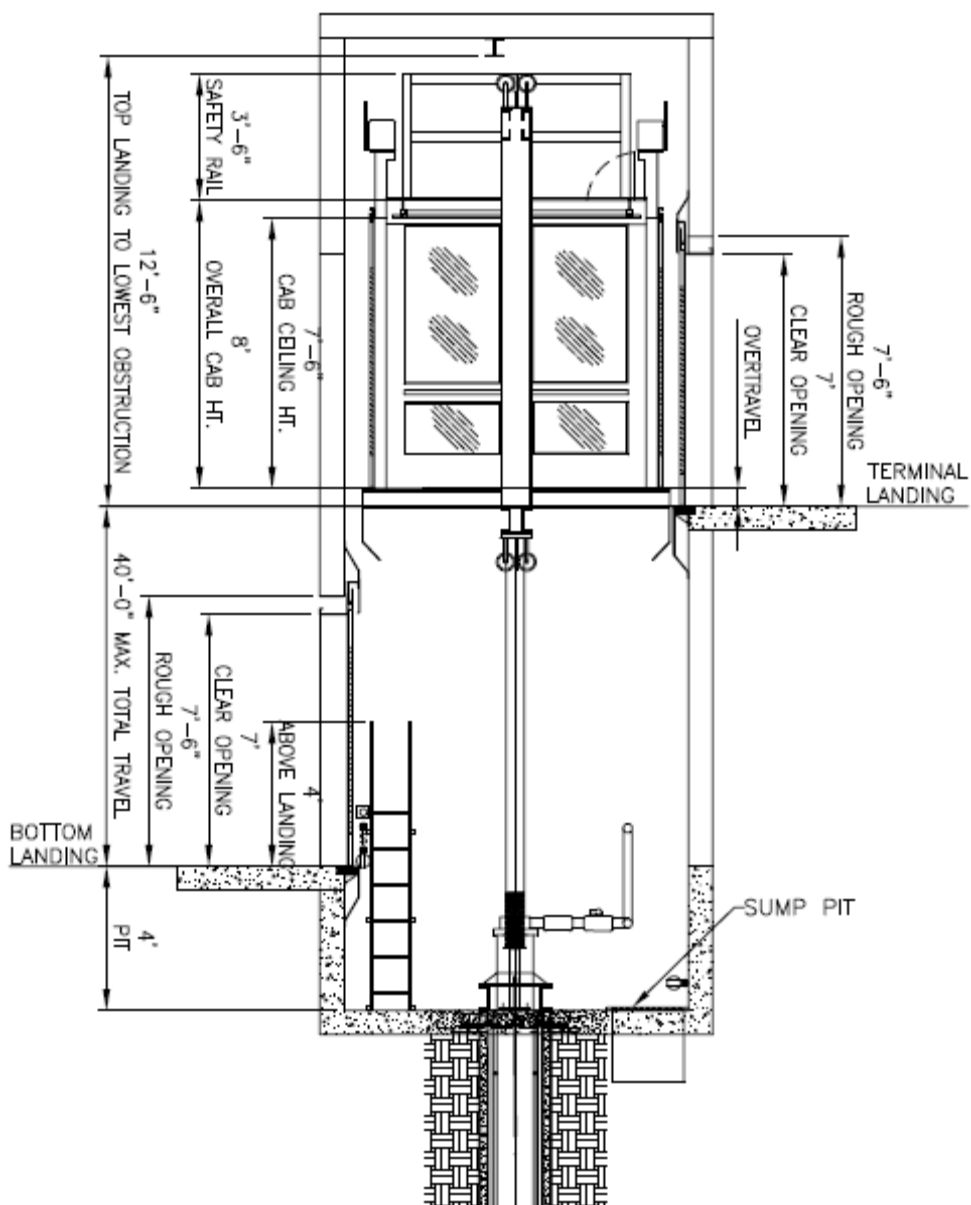

Direct Acting Inground Hydraulic Section Thru Hoistway Design Dimensions
(Pass through Entry Configuration w/ Single Speed Doors)

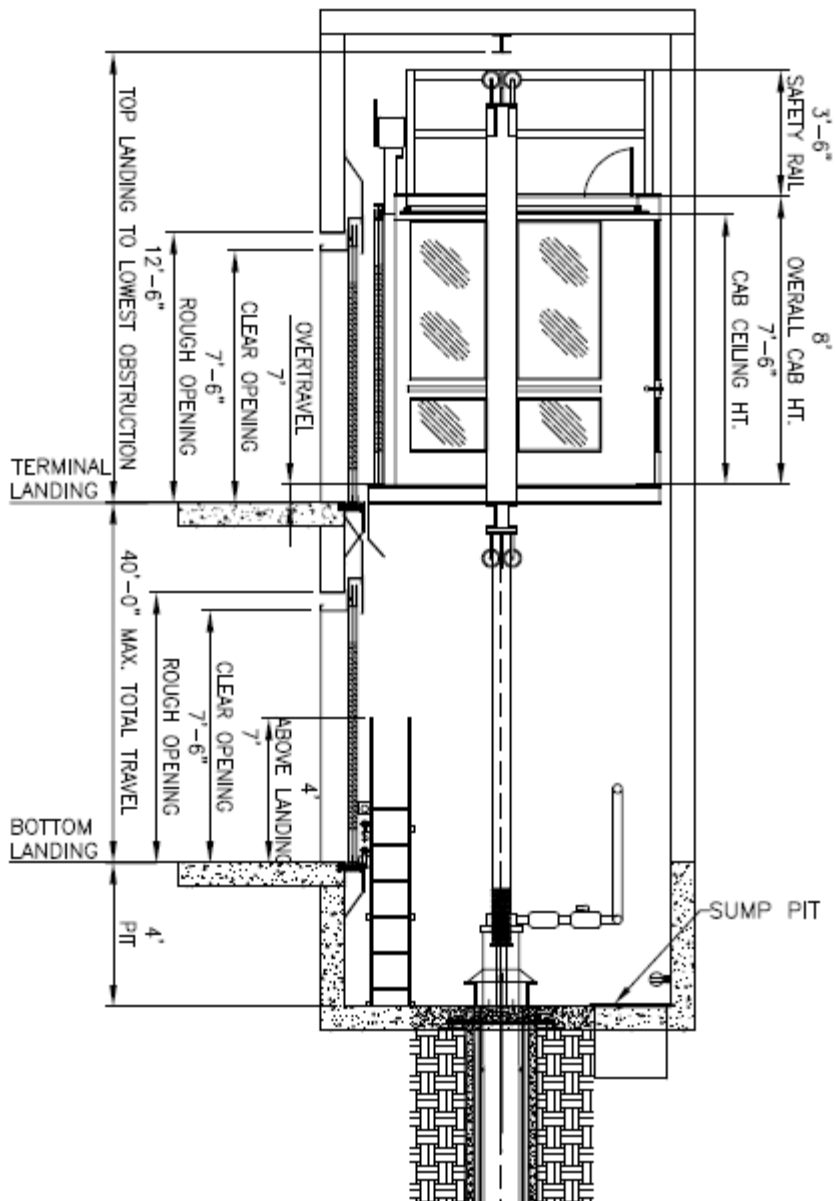

**Direct Acting Inground Hydraulic Section Thru Hoistway Design Dimensions
(Single Entry Configuration w/ Two Speed Doors)**

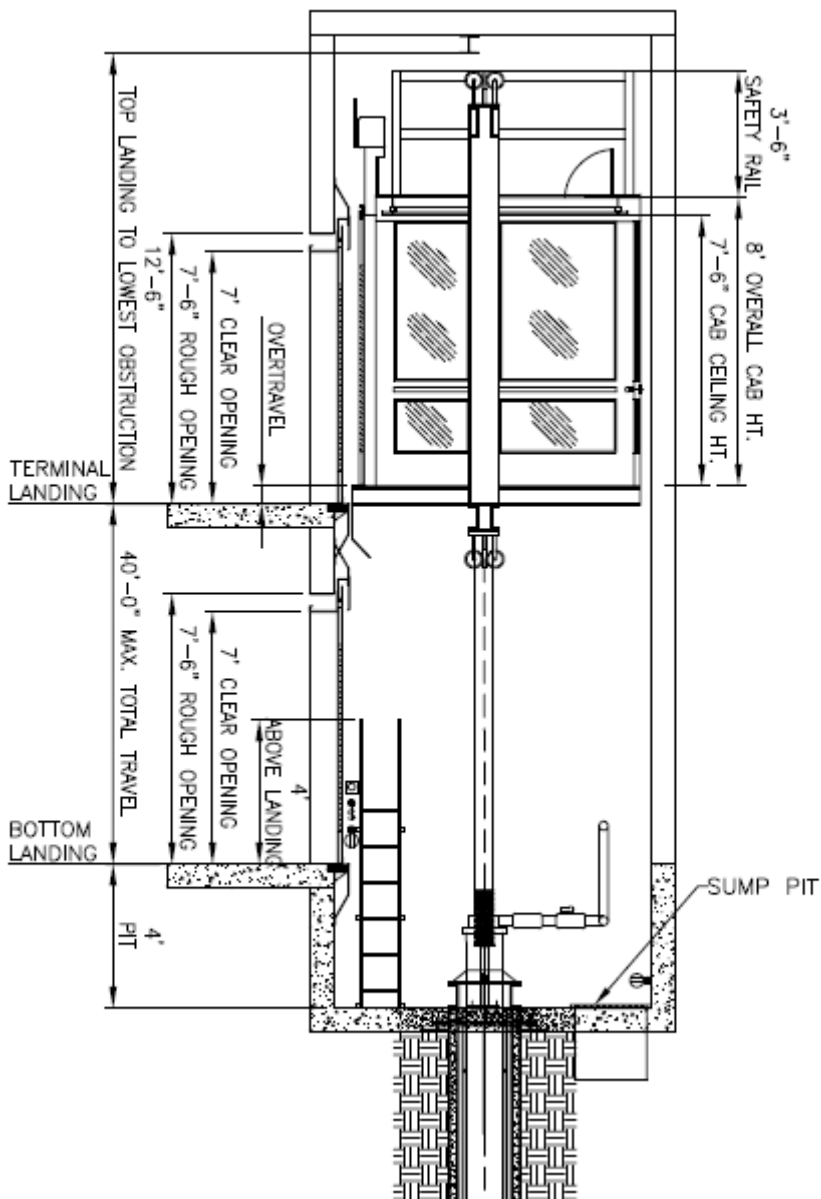

**Direct Acting Inground Hydraulic Section Thru Hoistway Design Dimensions
(Single Entry Configuration w/ Single Speed Doors)**

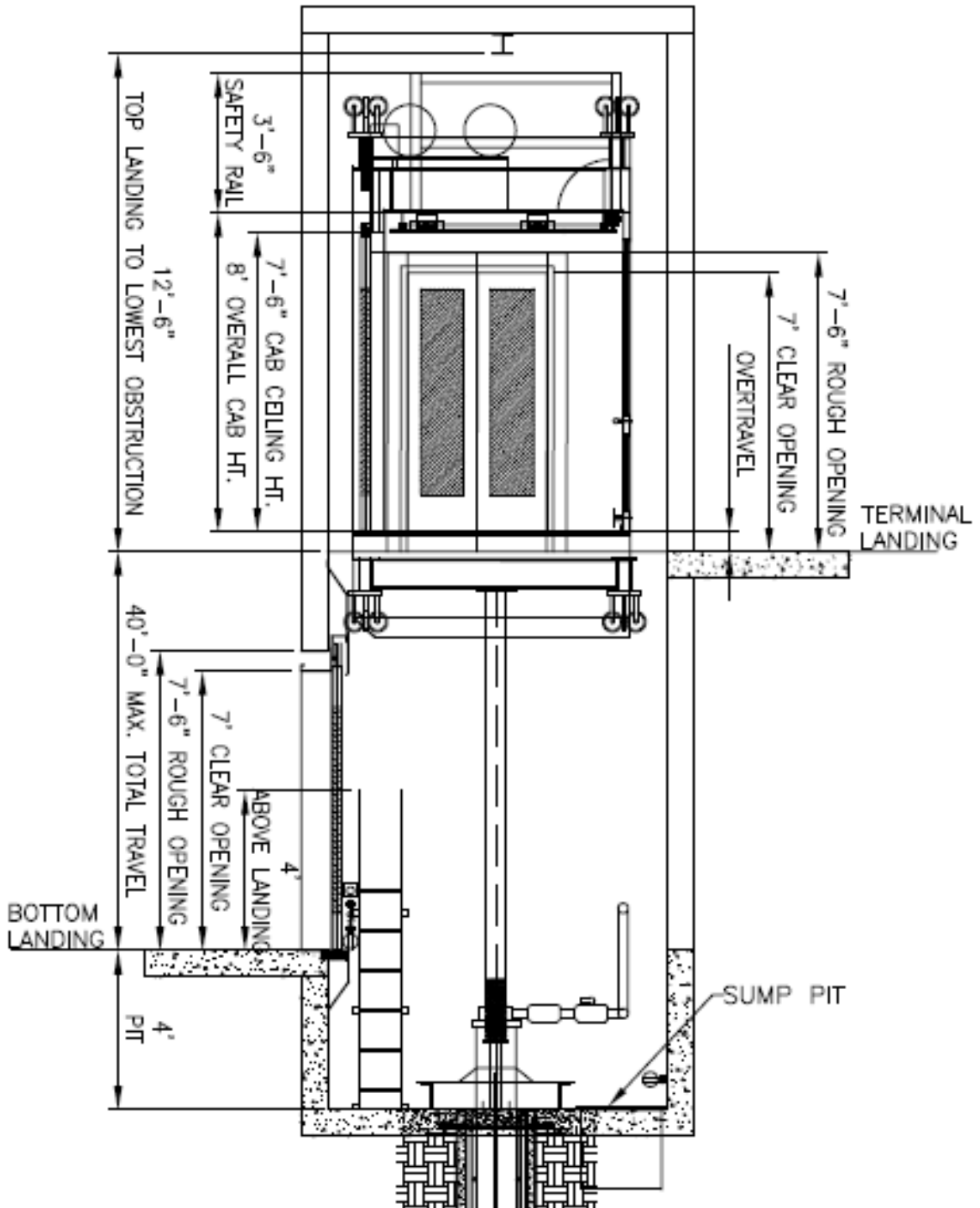

Direct Acting Inground Hydraulic Section Thru Hoistway Design Dimensions
(90 Degree Entry Configuration w/ Two Speed Doors)

APPENDIX A (Part 2)– Minimum Elevator Configuration Dimensions for ADA Compliancy

Machine Room Less (MRL):

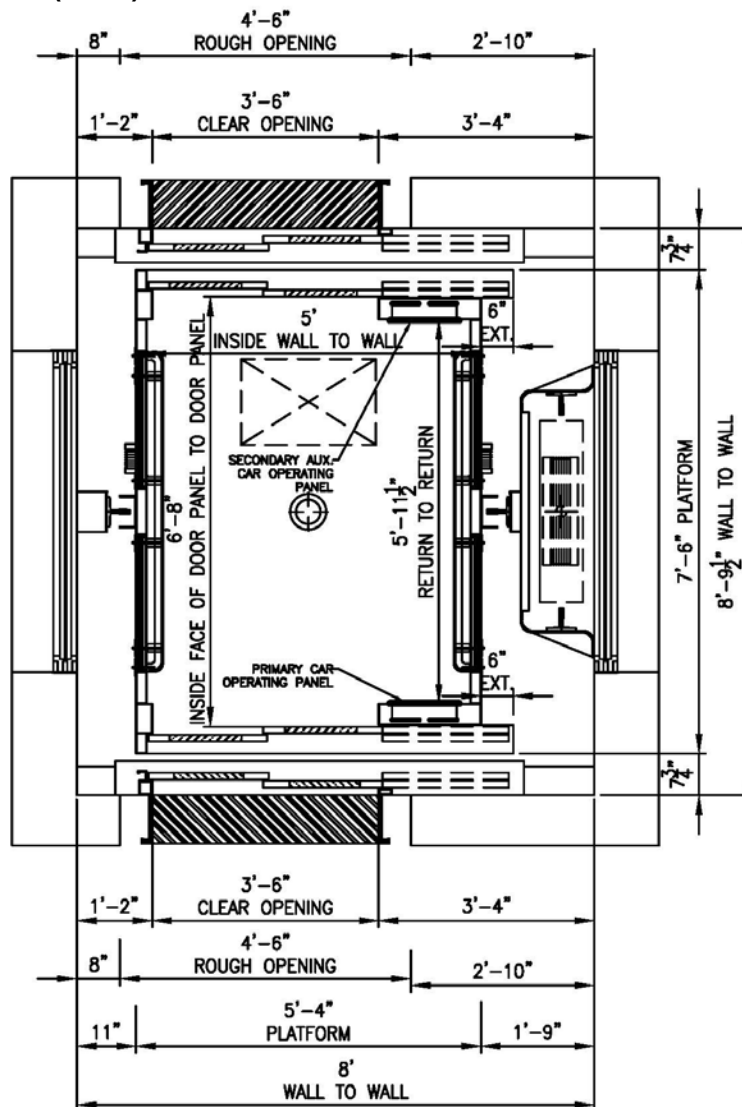

MRL Pass-through Design Dimensions (Two Speed Side Slide Doors)

Minimum Cab Width: 60" (1524 mm) wall to wall

Minimum Cab Depth: 80" (2032 mm) door panel to door panel

Above design dimensions are representative of APTA Guidelines and Seismic Zone 2 (i.e. IBC Class B or greater) loading/rating requirements.

Above dimensions do not compensate for conditions when there is occupied space below the elevator pit and counterweight safeties are required. Coordination is required with all elevator manufacturers on counterweight safety requirements and any potential increase to 1'-9" dimension.

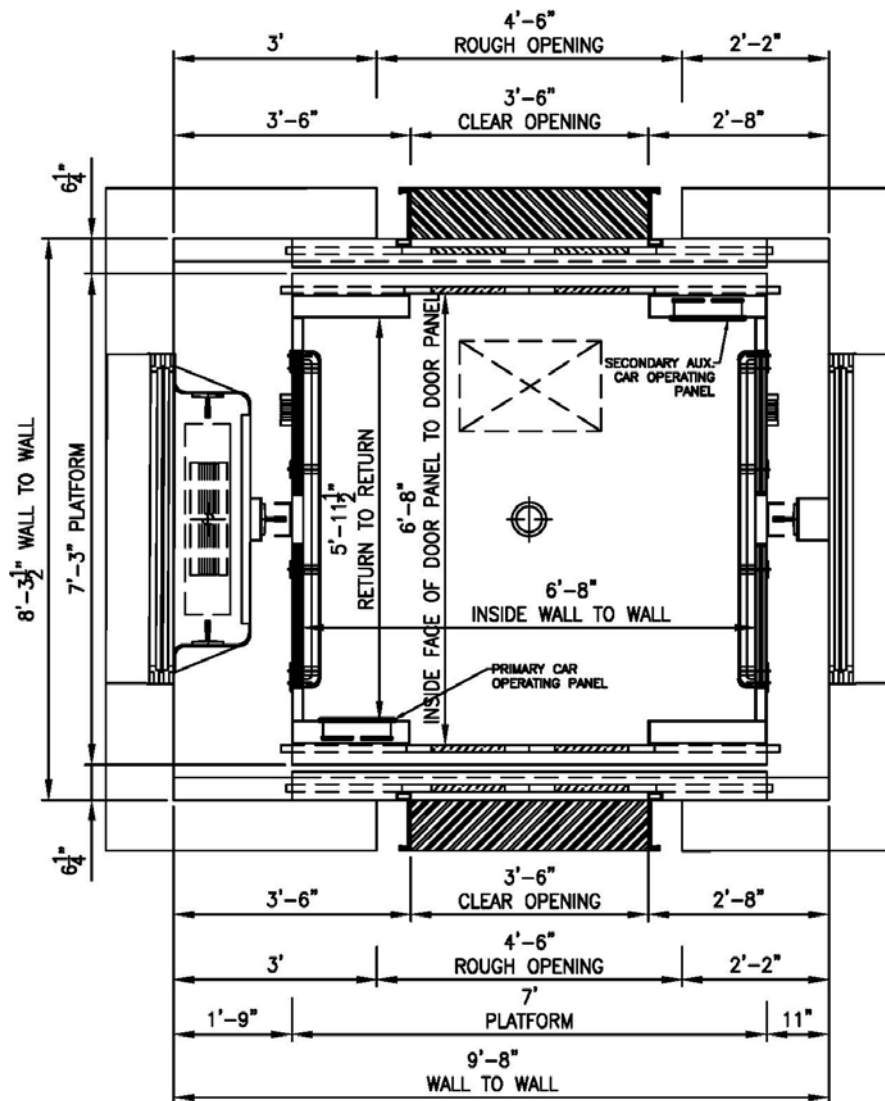

**MRL Pass-through Design Dimensions
(Single Speed Center Opening Doors)**

Minimum Cab Width: 80" (2032 mm) wall to wall

Minimum Cab Depth: 80" (2032 mm) door panel to door panel

Above design dimensions are representative of APTA Guidelines and Seismic Zone 2 (i.e. IBC Class B or greater) loading/rating requirements.

Above dimensions do not compensate for conditions when there is occupied space below the elevator pit and counterweight safeties are required. Coordination is required with all elevator manufacturers on counterweight safety requirements and any potential increase to 1'-9" dimension.

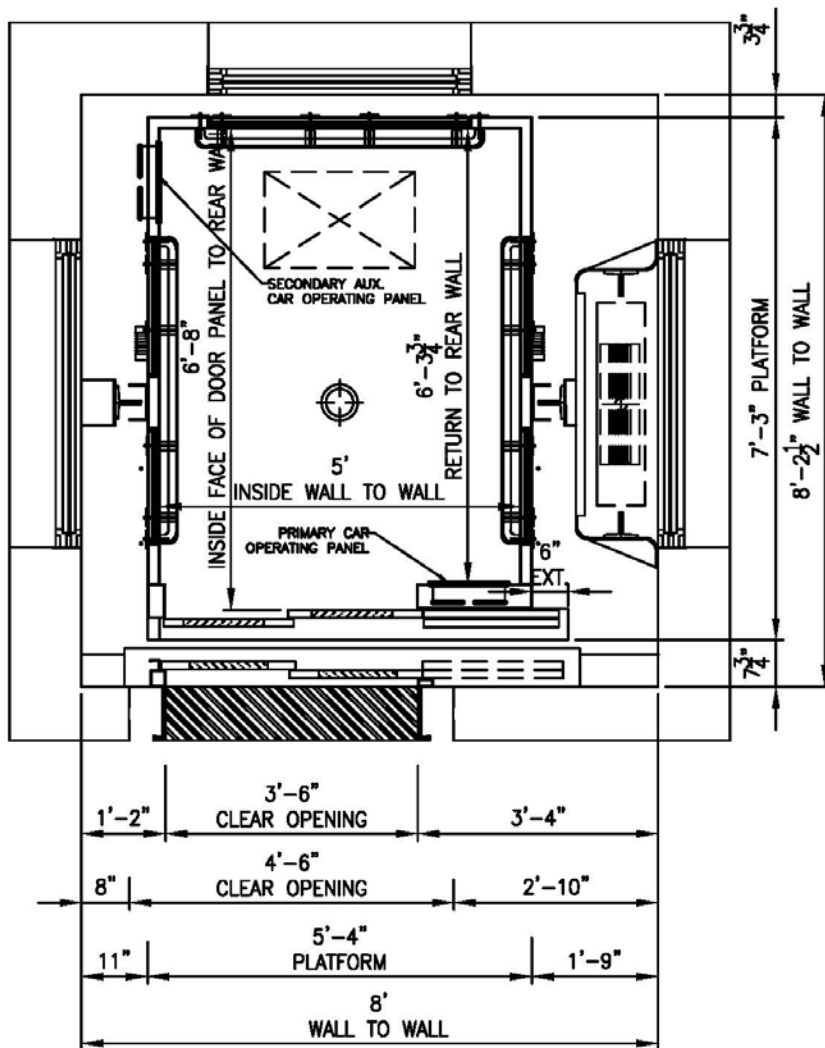

**MRL Single Entry Design Dimensions
(Two Speed Side Slide Door)**

Minimum Cab Width: 60" (1524 mm) wall to wall

Minimum Cab Depth: 80" (2032 mm) door panel to wall

Above design dimensions are representative of APTA Guidelines and Seismic Zone 2 (i.e. IBC Class B or greater) loading/rating requirements.

Above dimensions do not compensate for conditions when there is occupied space below the elevator pit and counterweight safeties are required. Coordination is required with all elevator manufacturers on counterweight safety requirements and any potential increase to 1'-9" dimension.

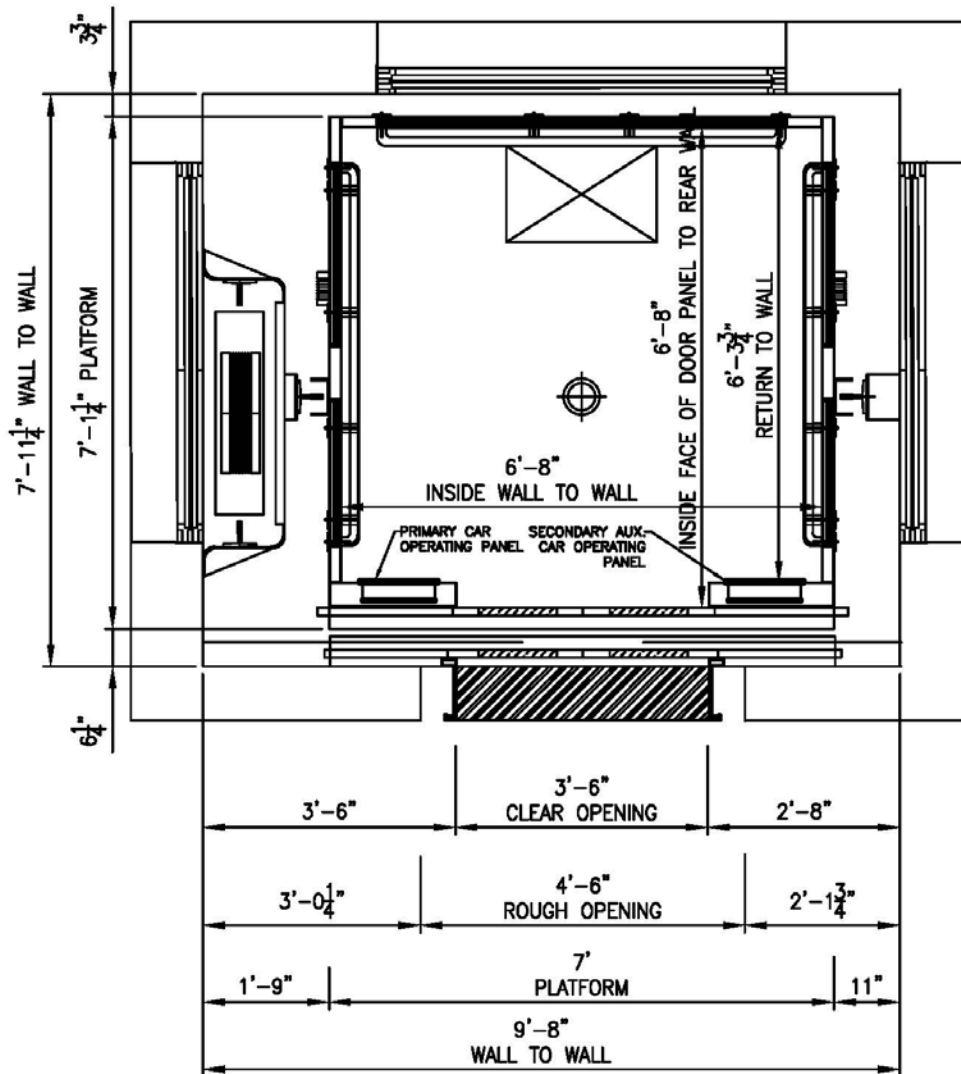

**MRL Single Entry Design Dimensions
(Single Speed Center Opening Door)**

Minimum Cab Width: 80" (2032 mm) wall to wall

Minimum Cab Depth: 80" (2032 mm) door panel to wall

Above design dimensions are representative of APTA Guidelines and Seismic Zone 2 (i.e. IBC Class B or greater) loading/rating requirements.

Above dimensions do not compensate for conditions when there is occupied space below the elevator pit and counterweight safeties are required. Coordination is required with all elevator manufacturers on counterweight safety requirements and any potential increase to 1'-9" dimension.

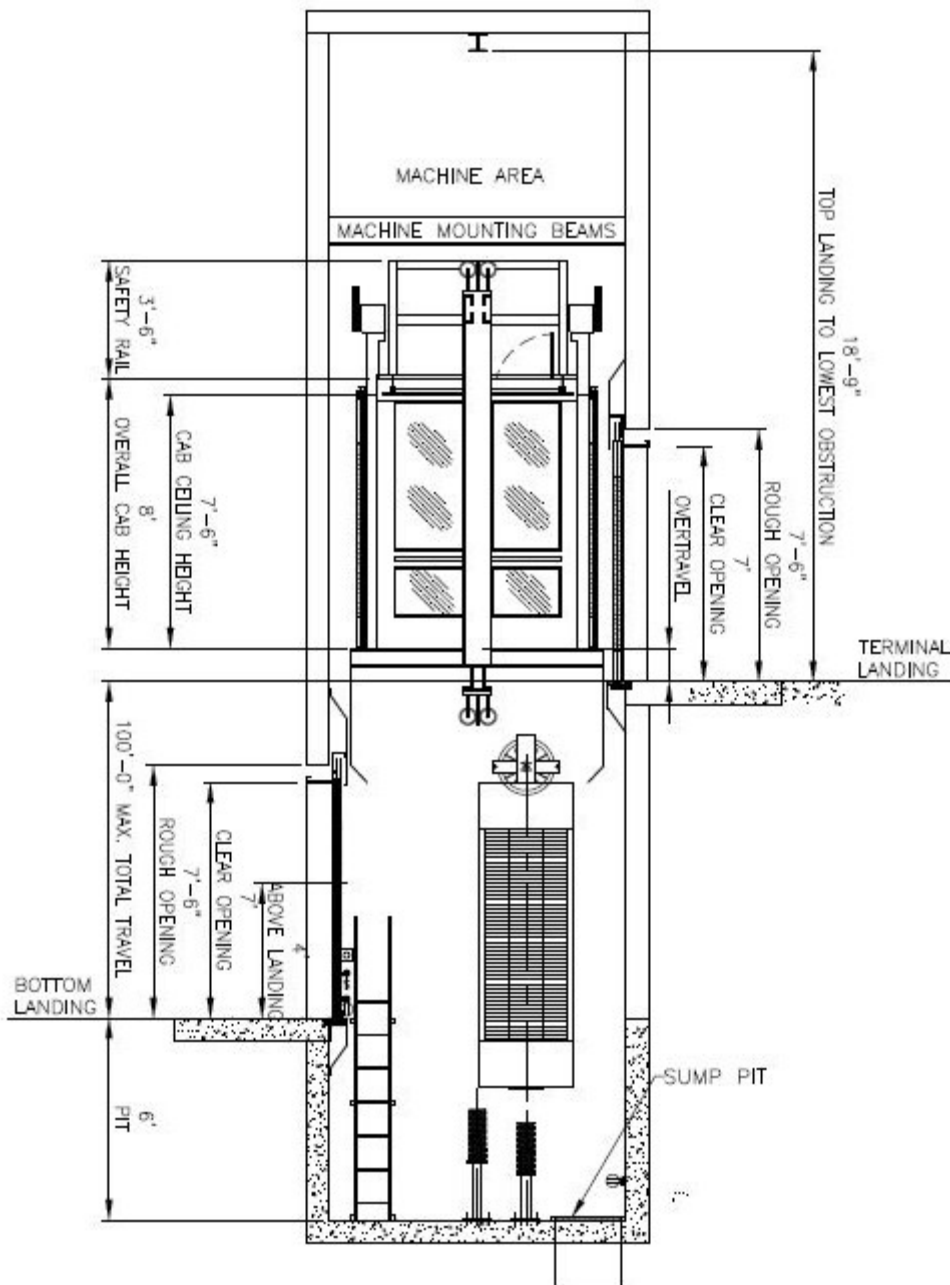

**MRL Section Thru Hoistway Design Dimensions
 (Pass-through Configuration w/ Two Speed Doors)**

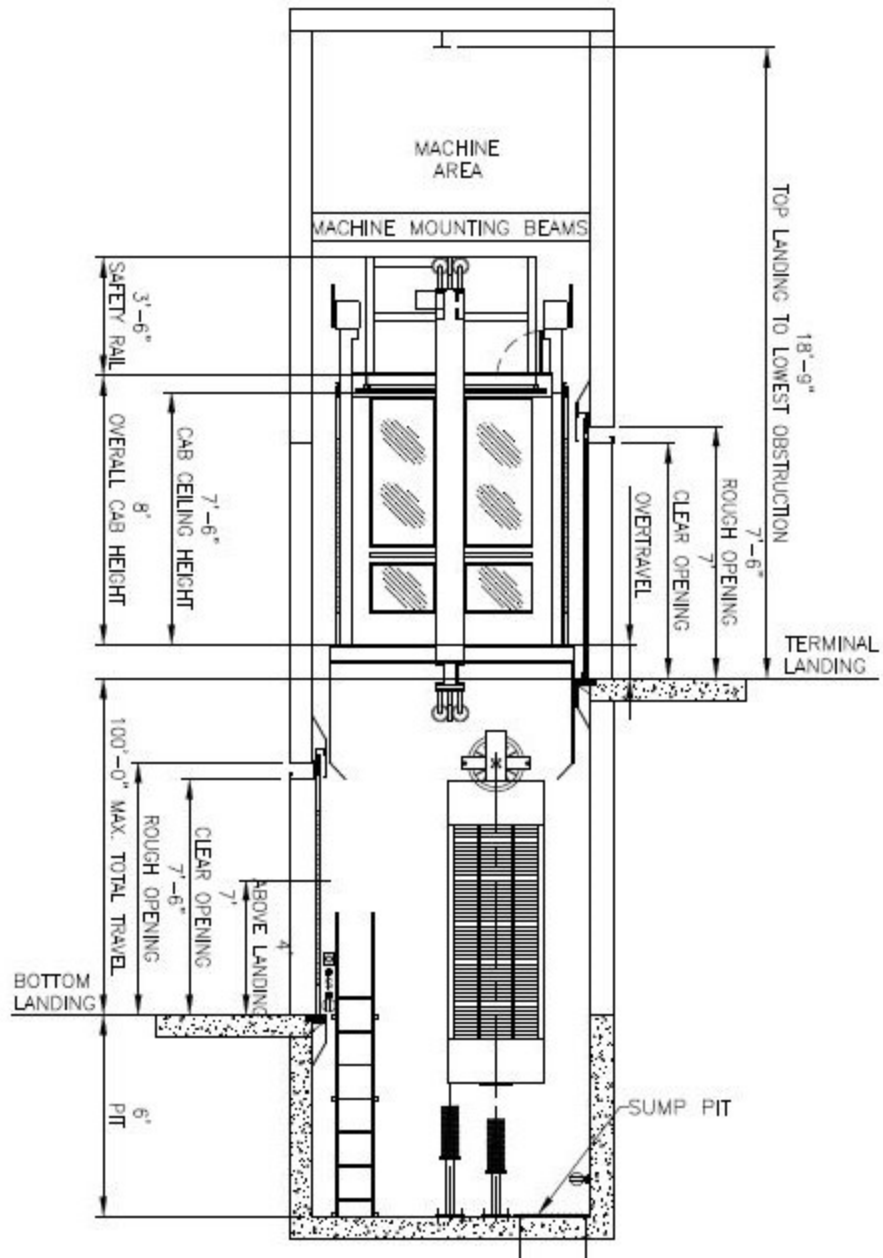

**MRL Section Thru Hoistway Design Dimensions
 (Pass-through Configuration w/ Single Speed Center Opening Doors)**

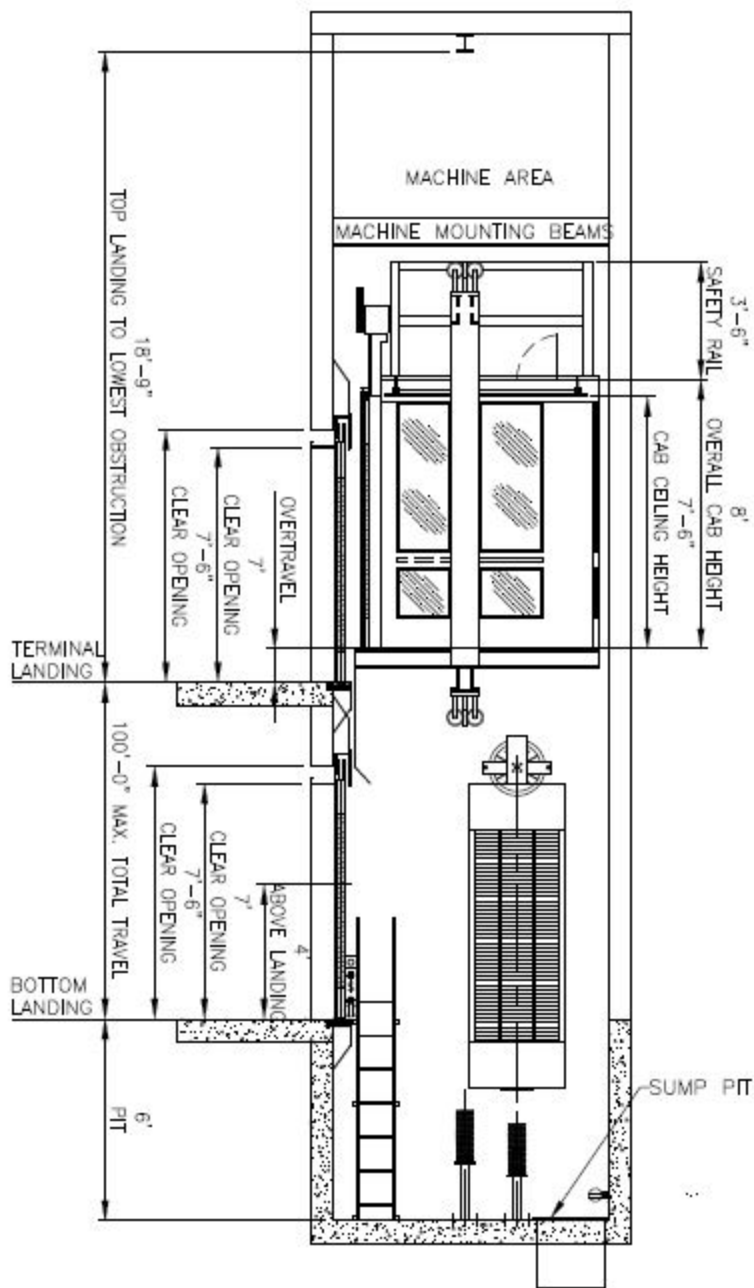

**MRL Section Thru Hoistway Design Dimensions
 (Single Entry Configuration w/ Two Speed Doors)**

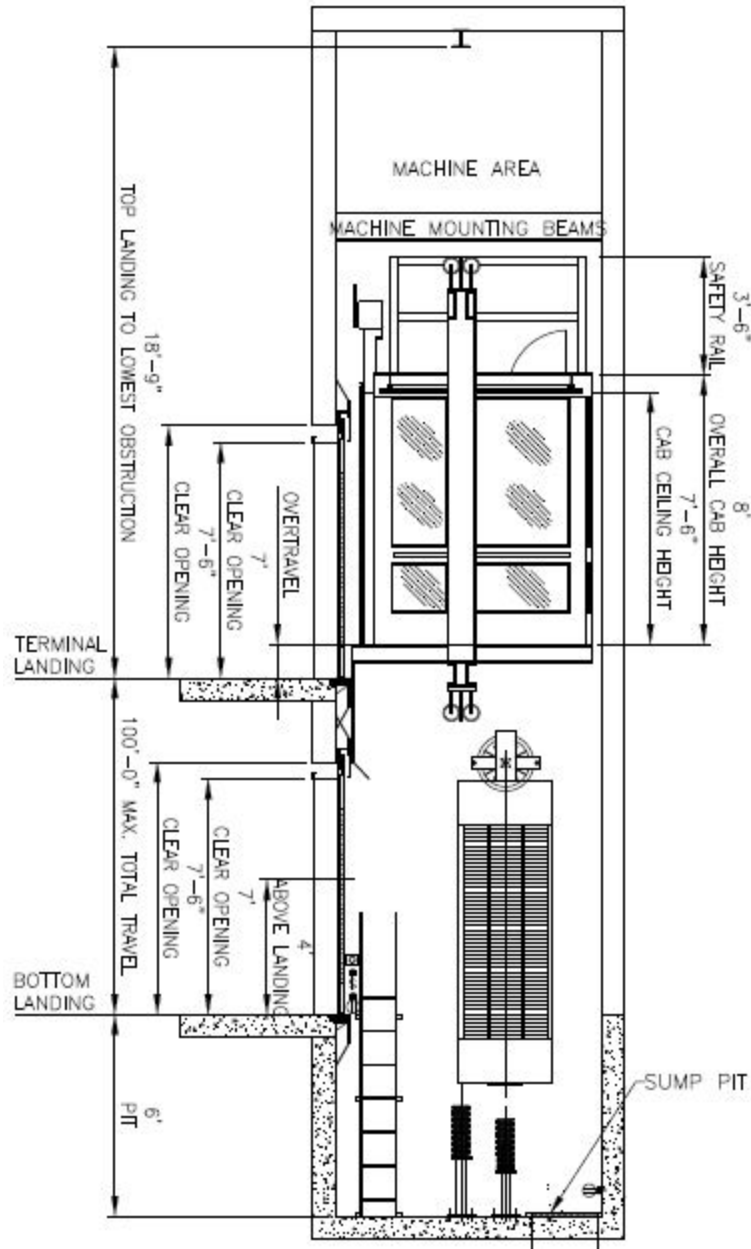

**MRL Section Thru Hoistway Design Dimensions
(Single Entry Configuration w/ Single Speed Center Opening Doors)**

Direct Acting Inground Hydraulic:

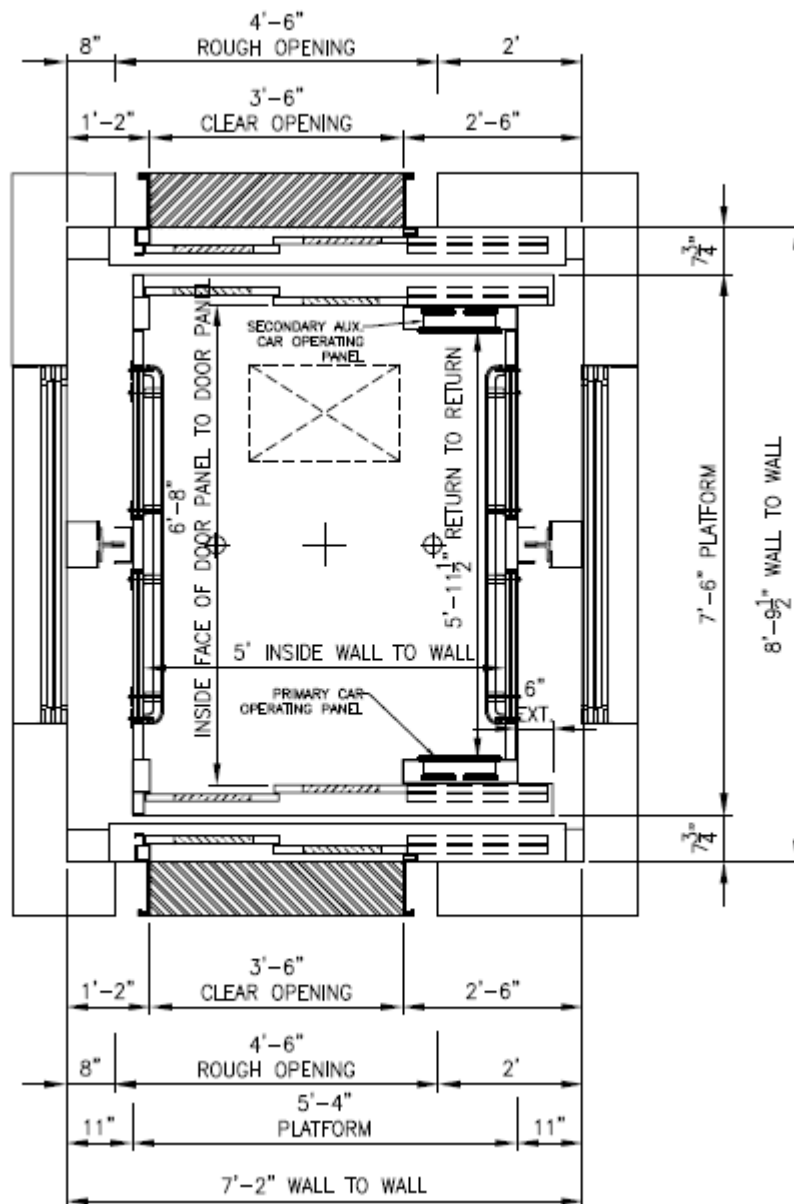

**Direct Acting Inground Hydraulic Pass-through Design Dimensions
 (Two Speed Side Slide Doors)**

Minimum Cab Width: 60" (1524 mm) wall to wall

Minimum Cab Depth: 80" (2032 mm) door panel to door panel

Above design dimensions are representative of APTA Guidelines and Seismic Zone 2 (i.e. IBC Class B or greater) loading/rating requirements.

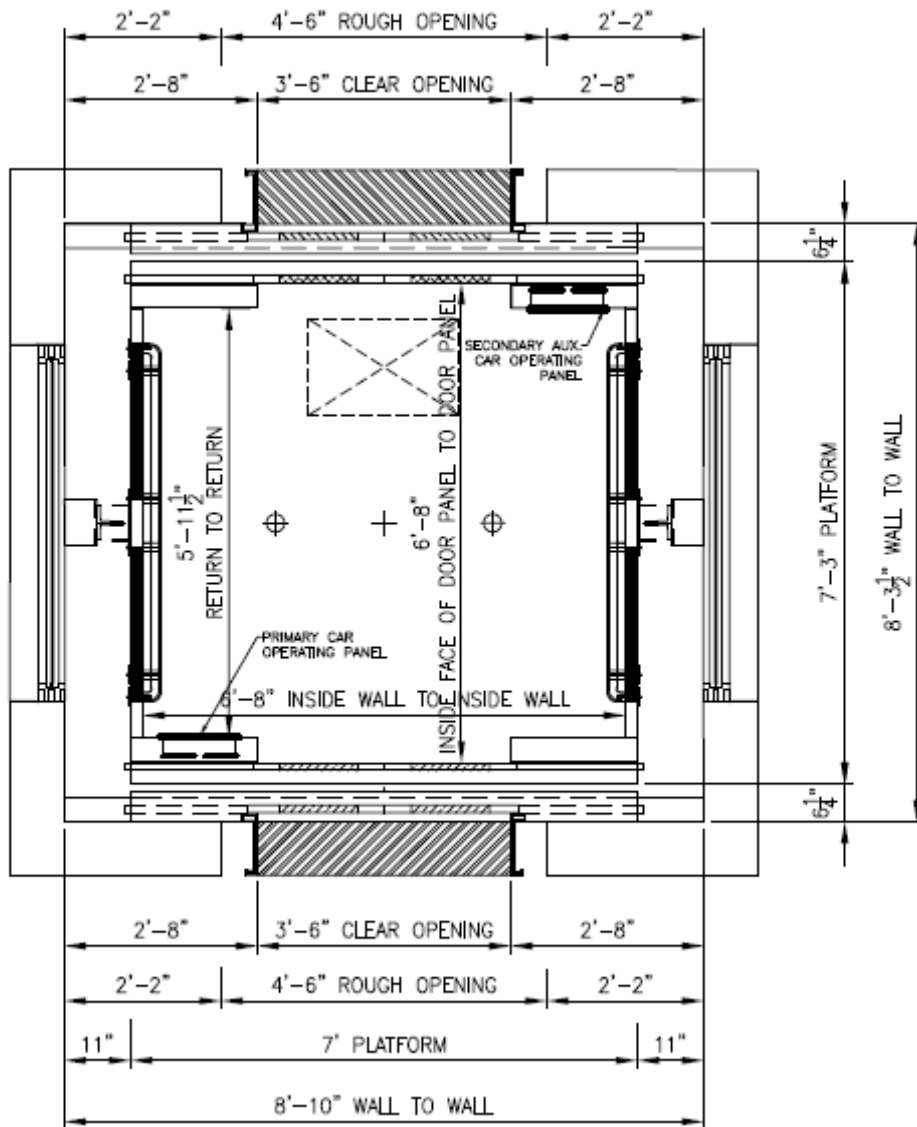

**Direct Acting Inground Hydraulic Pass-through Design Dimensions
 (Single Speed Center Opening Doors)**

Minimum Cab Width: 80" (2032 mm) wall to wall

Minimum Cab Depth: 80" (2032 mm) door panel to door panel

Above design dimensions are representative of APTA Guidelines and Seismic Zone 2 (i.e. IBC Class B or greater) loading/rating requirements.

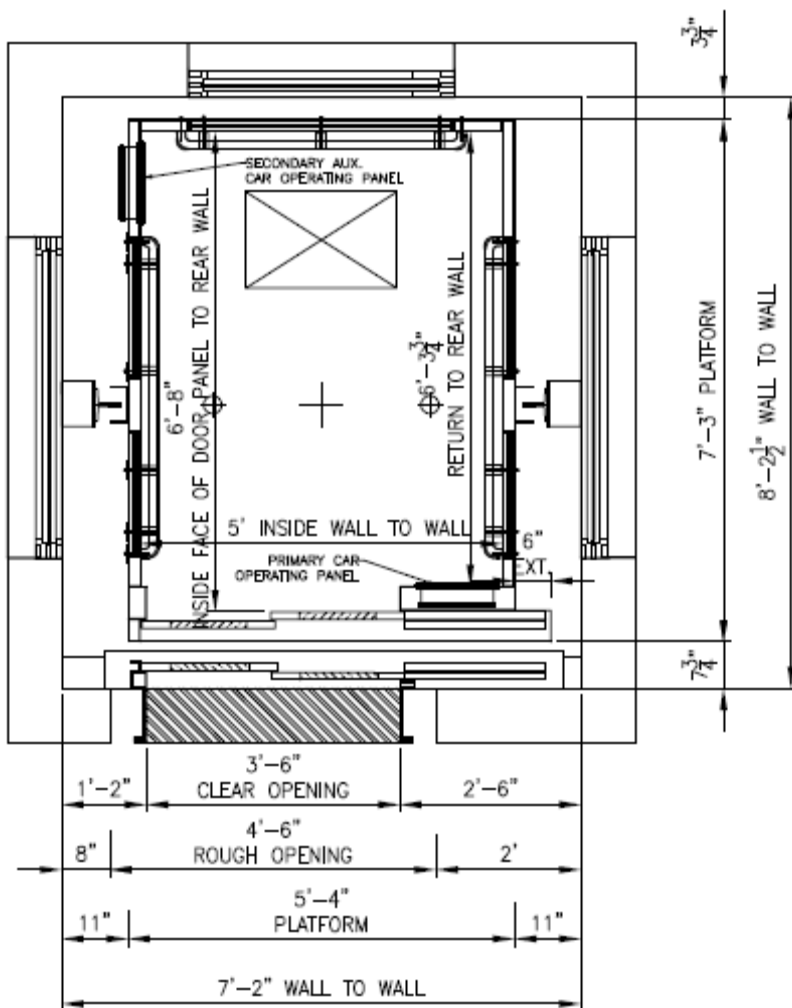

**Direct Acting Inground Hydraulic Single Entry Design Dimensions
(Two Speed Side Slide Door)**

Minimum Cab Width: 60" (1524 mm) wall to wall

Minimum Cab Depth: 80" (2032 mm) door panel to wall

Above design dimensions are representative of APTA Guidelines and Seismic Zone 2 (i.e. IBC Class B or greater) loading/rating requirements.

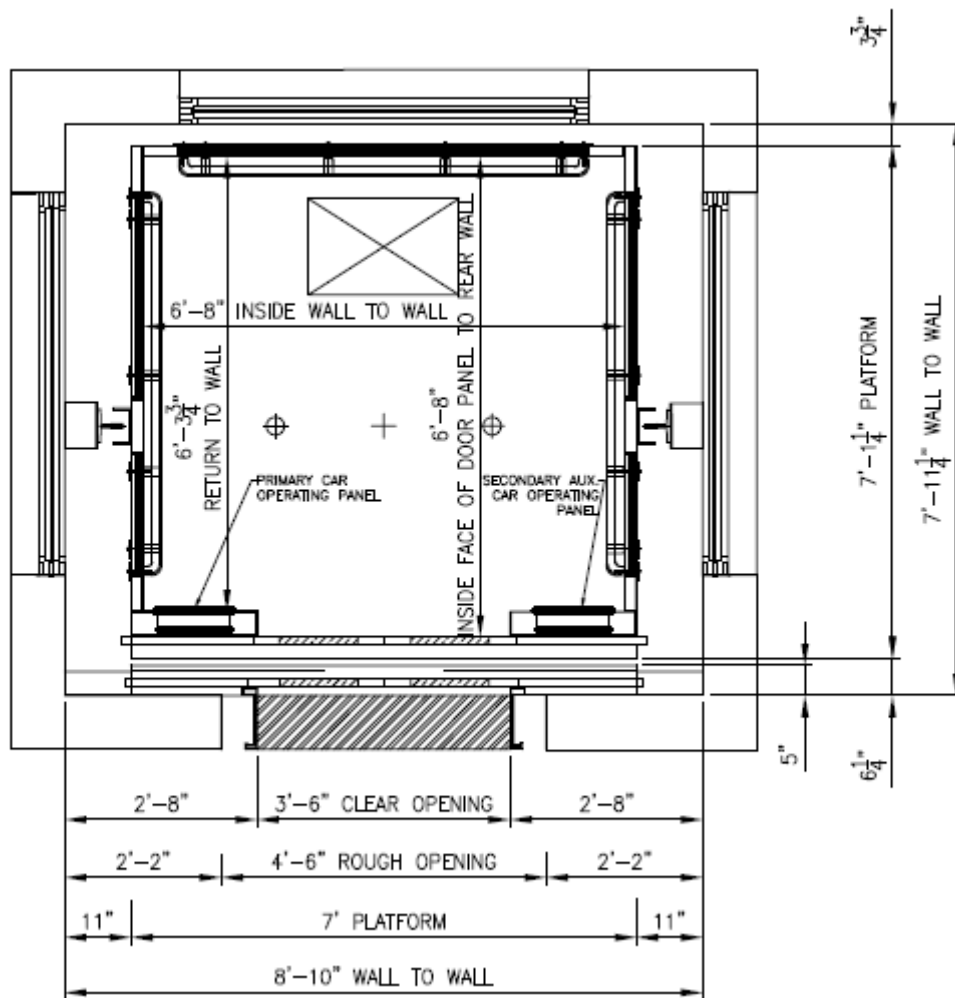

**Direct Acting Inground Hydraulic Single Entry Design Dimensions
 (Single Speed Center Opening Door)**

Minimum Cab Width: 80" (2032 mm) wall to wall

Minimum Cab Depth: 80" (2032 mm) door panel to wall

Above design dimensions are representative of APTA Guidelines and Seismic Zone 2 (i.e. IBC Class B or greater) loading/rating requirements.

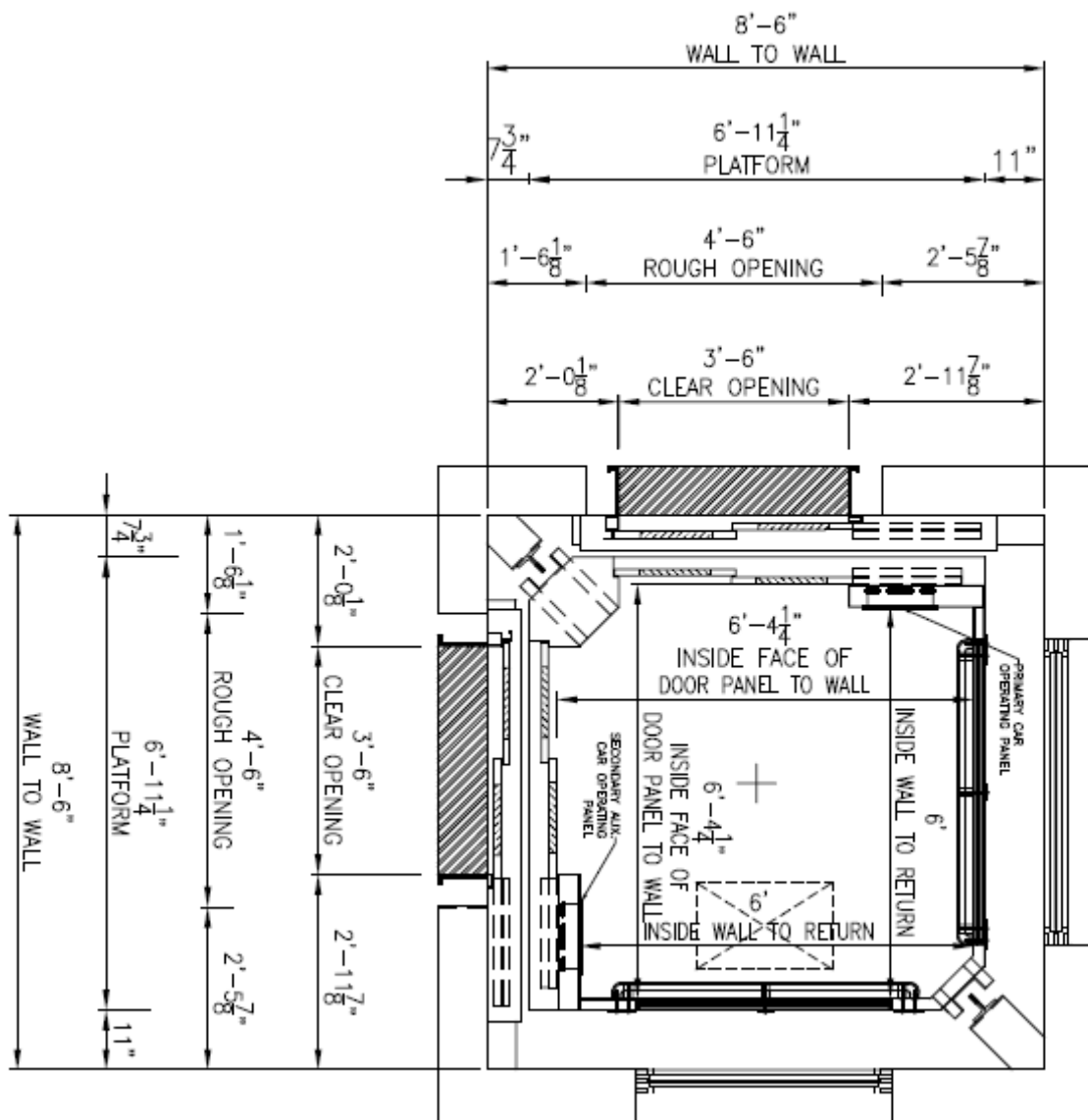

**Direct Acting Inground Hydraulic 90-Degree Design Dimensions
(Two Speed Side Slide Doors)**

Minimum Cab Width: 72" (1828 mm) return to wall

Minimum Cab Depth: 72" (1828 mm) return to wall

Above design dimensions are representative of APTA Guidelines and Seismic Zone 2 (i.e. IBC Class B or greater) loading/rating requirements.

Elevator sill to platform reference dimension (i.e. 7³/₄") shall remain constant.

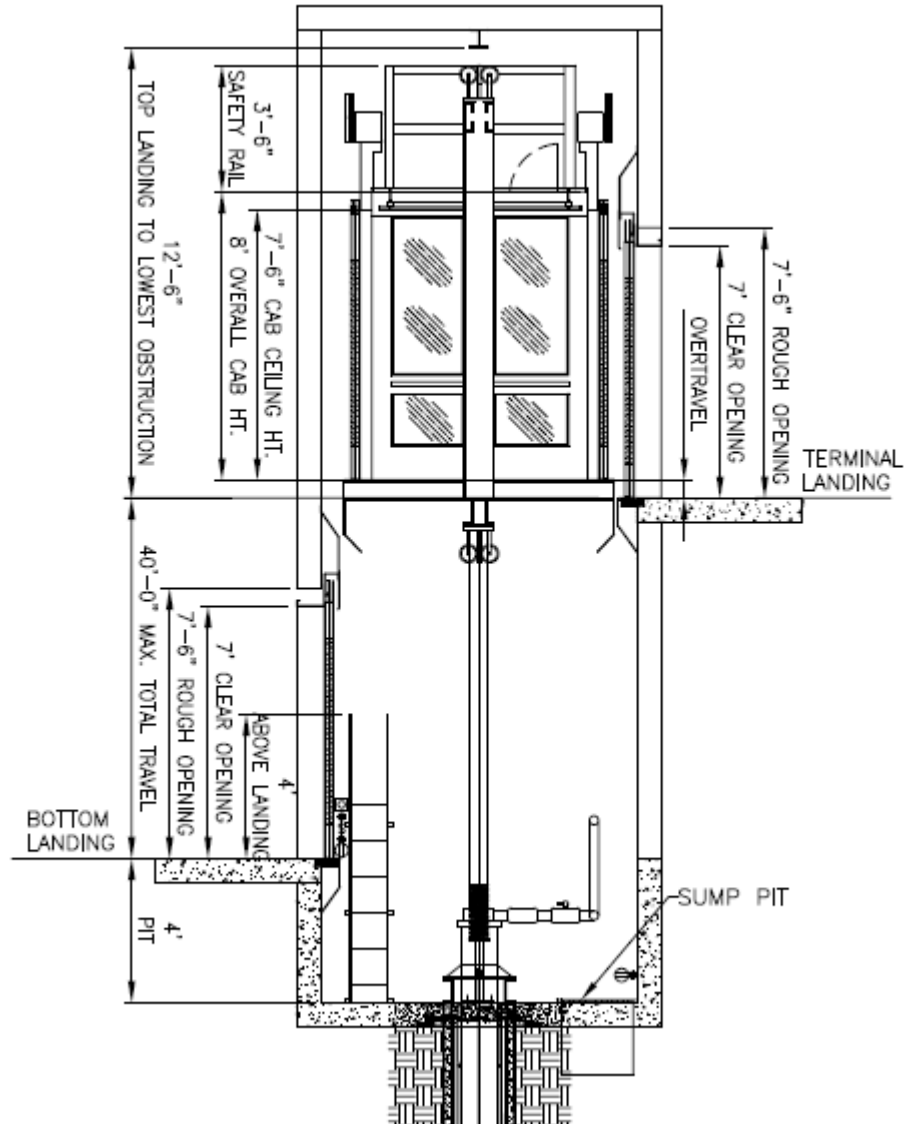

**Direct Acting Inground Hydraulic Section Thru Hoistway Design Dimensions
(Pass through Entry Configuration w/ Two Speed Doors)**

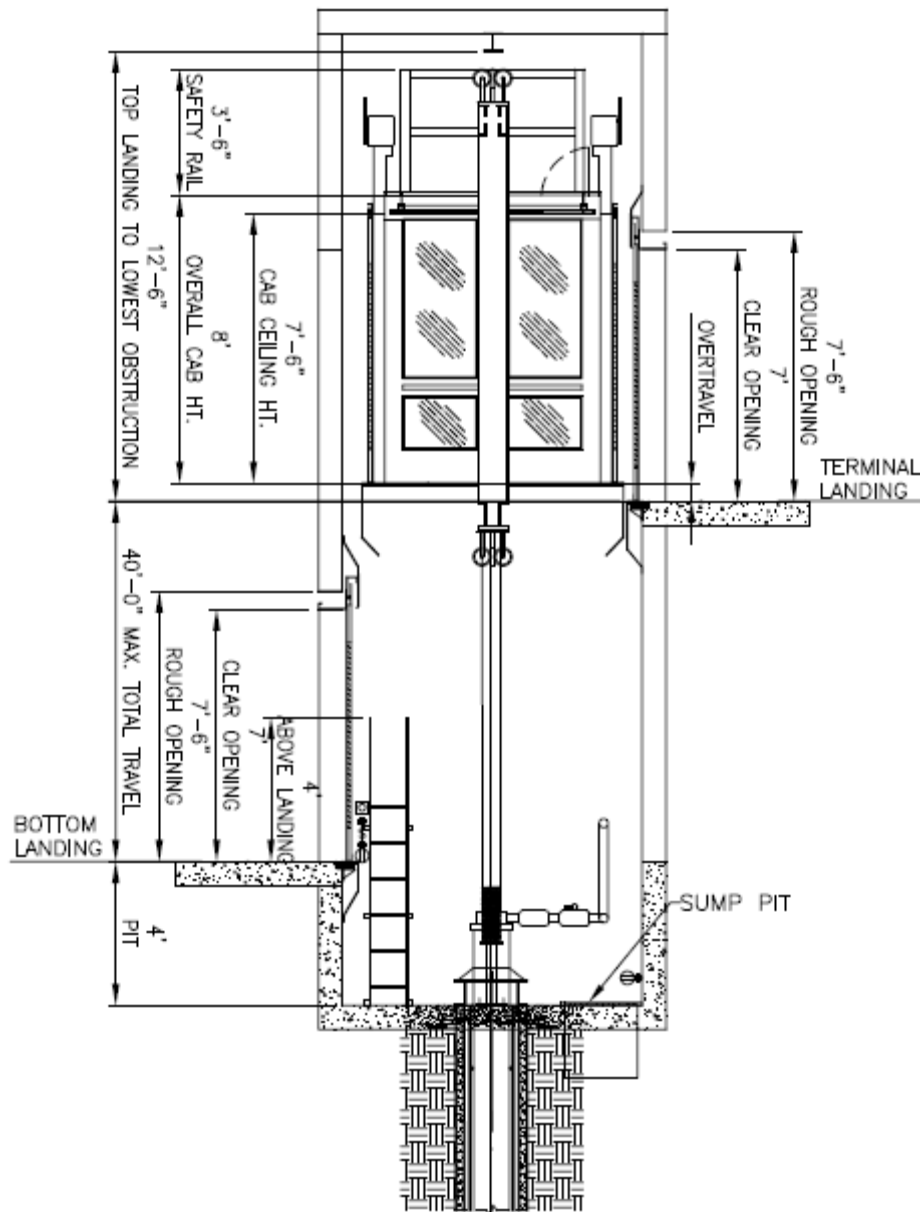

**Direct Acting Inground Hydraulic Section Thru Hoistway Design Dimensions
(Pass through Entry Configuration w/ Single Speed Doors)**

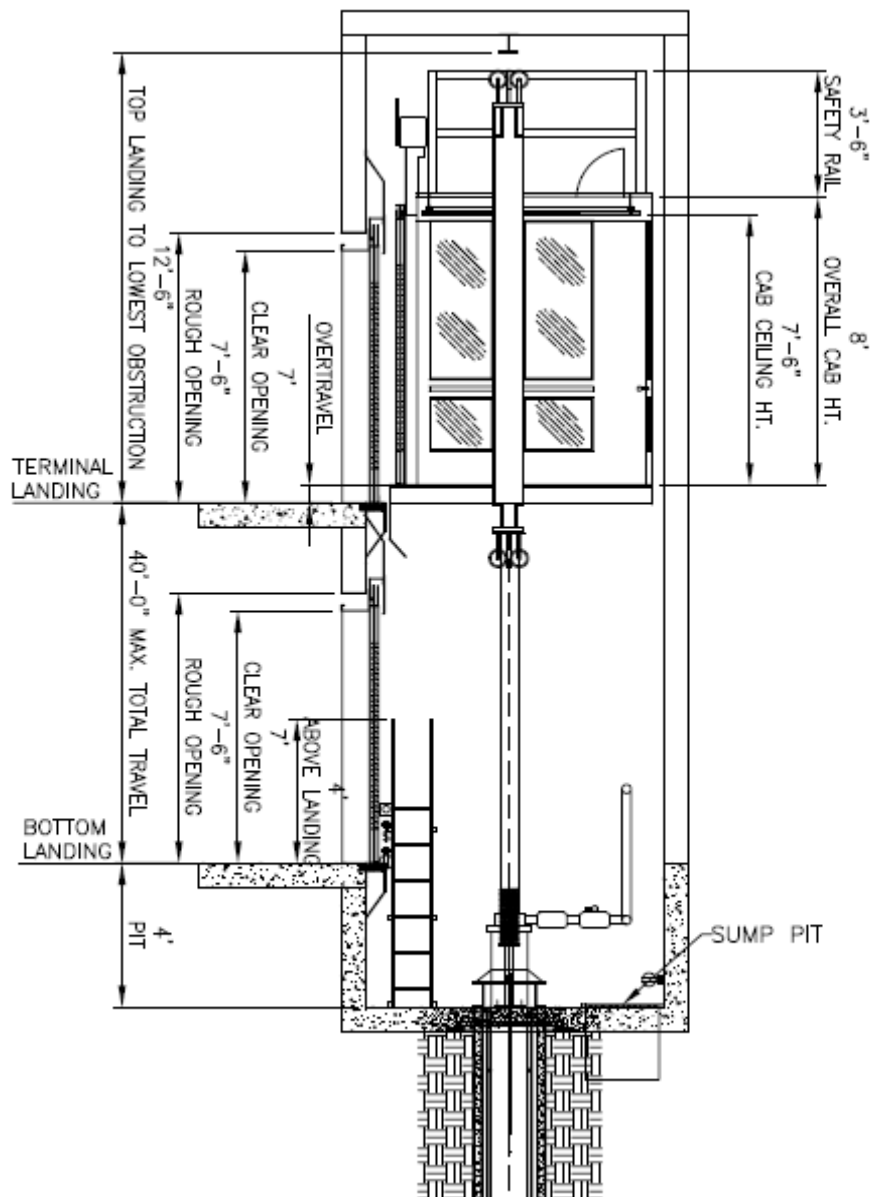

**Direct Acting Inground Hydraulic Section Thru Hoistway Design Dimensions
(Single Entry Configuration w/ Two Speed Doors)**

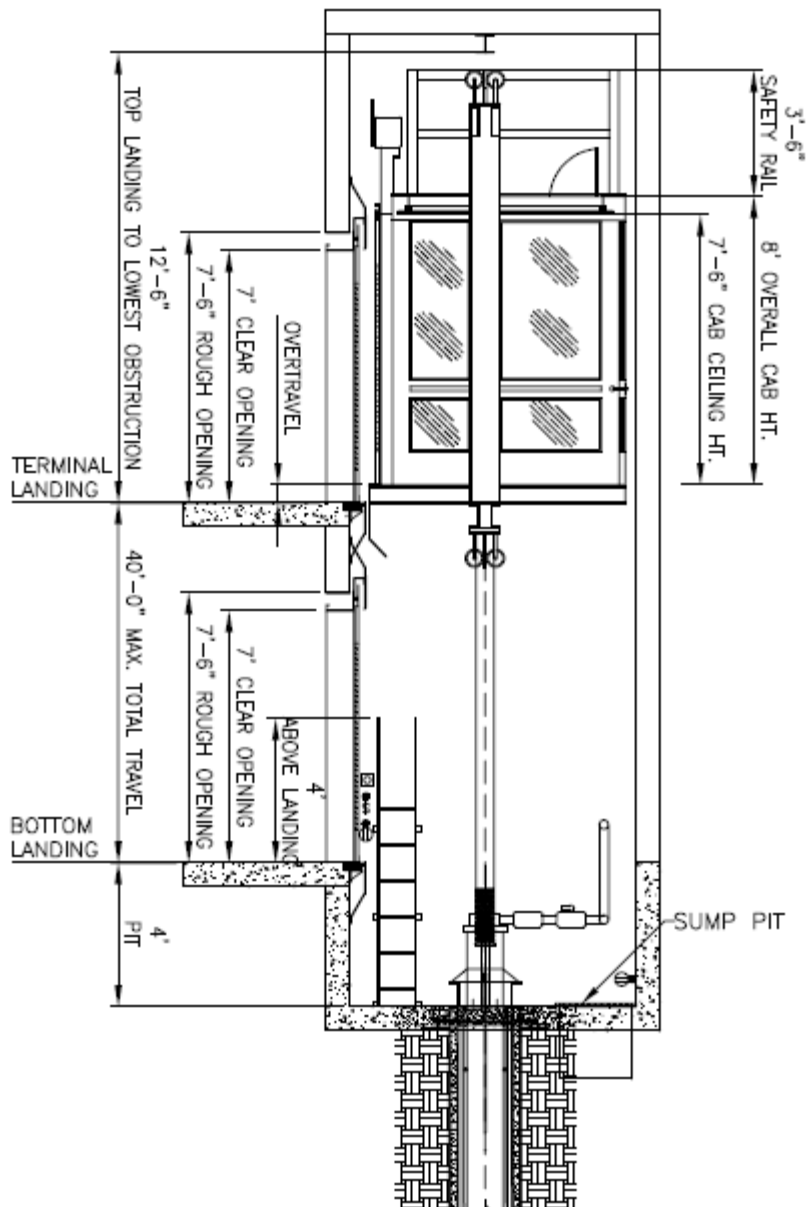

Direct Acting Inground Hydraulic Section Thru Hoistway Design Dimensions
(Single Entry Configuration w/ Single Speed Doors)

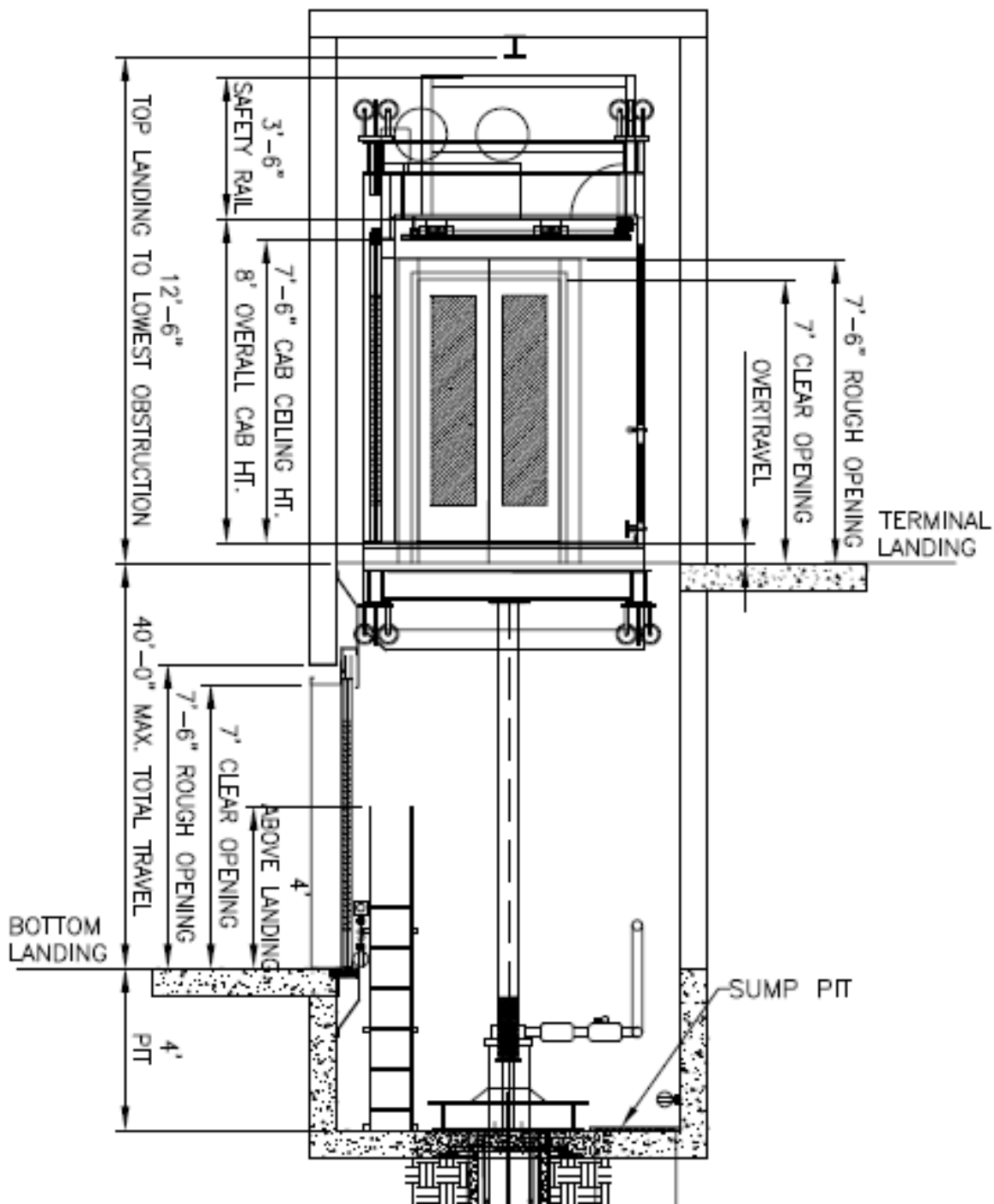

**Direct Acting Inground Hydraulic Section Thru Hoistway Design Dimensions
 (90 Degree Entry Configuration w/ Two Speed Doors)**

Machine Room Less (MRL):

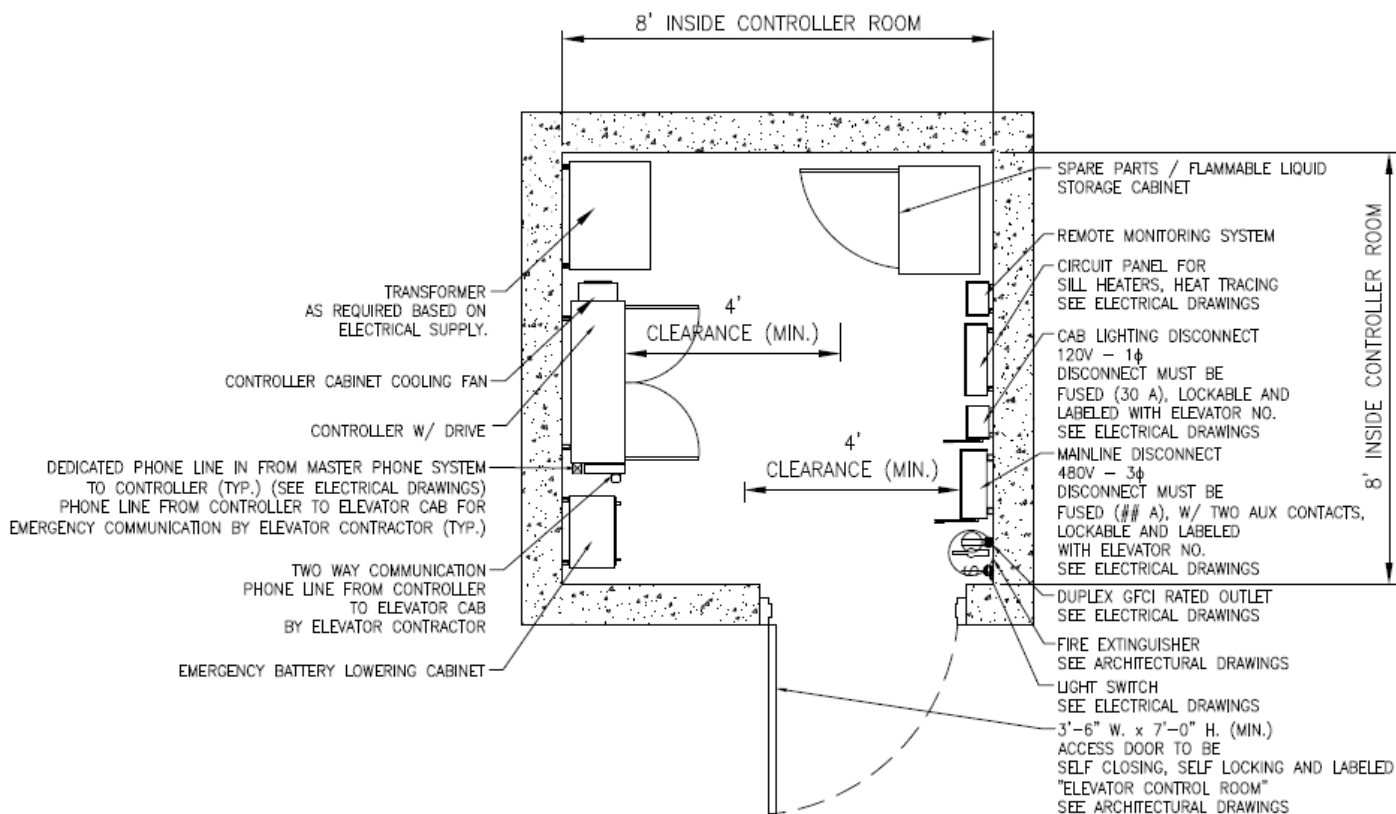

Typical Controller Room Dimensions

Direct Acting Inground Hydraulic:

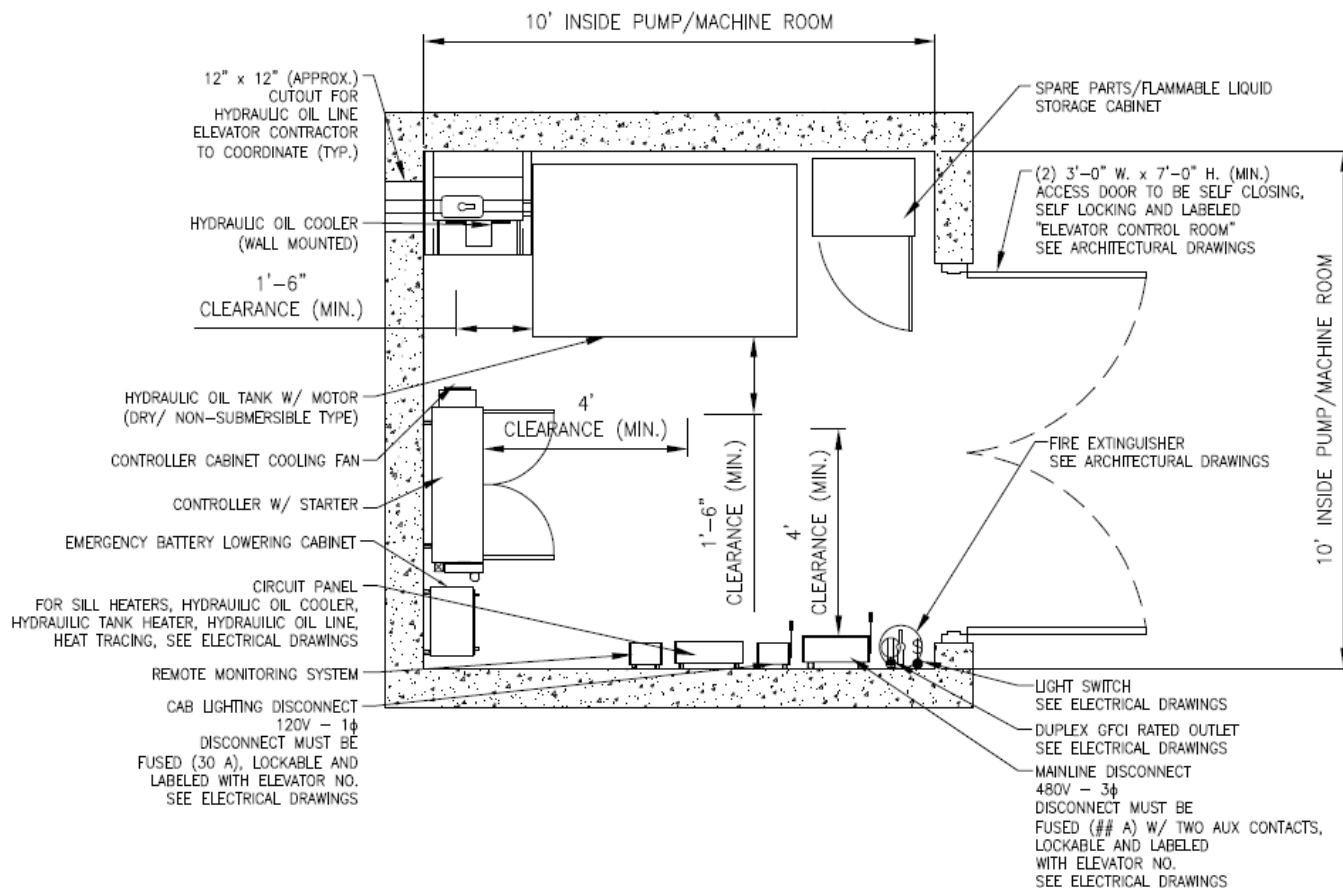

Typical Hydraulic Machine Room Dimensions

9th Edition Advisory Note Appendix A- Hydraulic Machine Rooms: The graphic above represents a 10 x 10 hydraulic elevator machine room that should be utilized when sizing ADA compliant elevators with **no stretcher** requirements.

Machine Room Less (MRL):

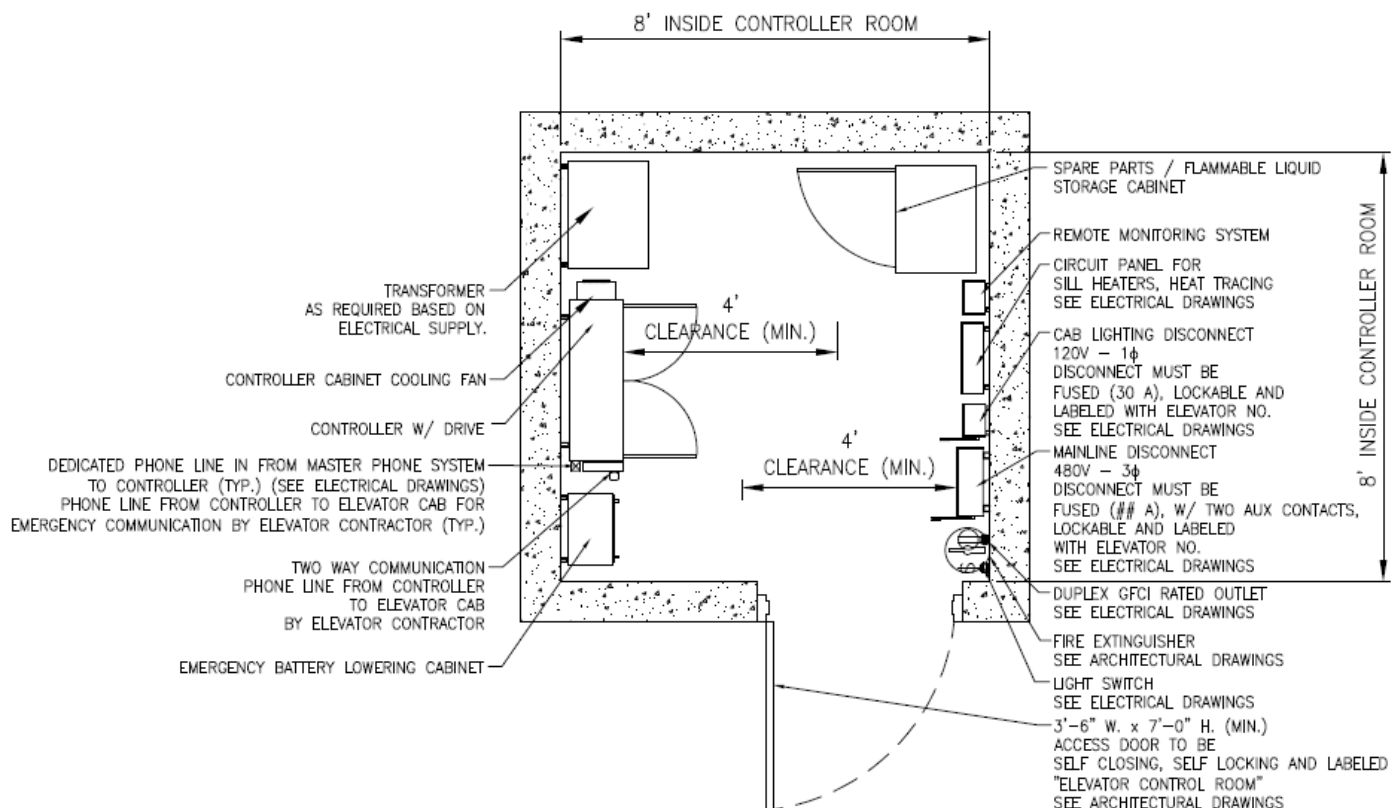

Typical Controller Room Dimensions

Direct Acting Inground Hydraulic:

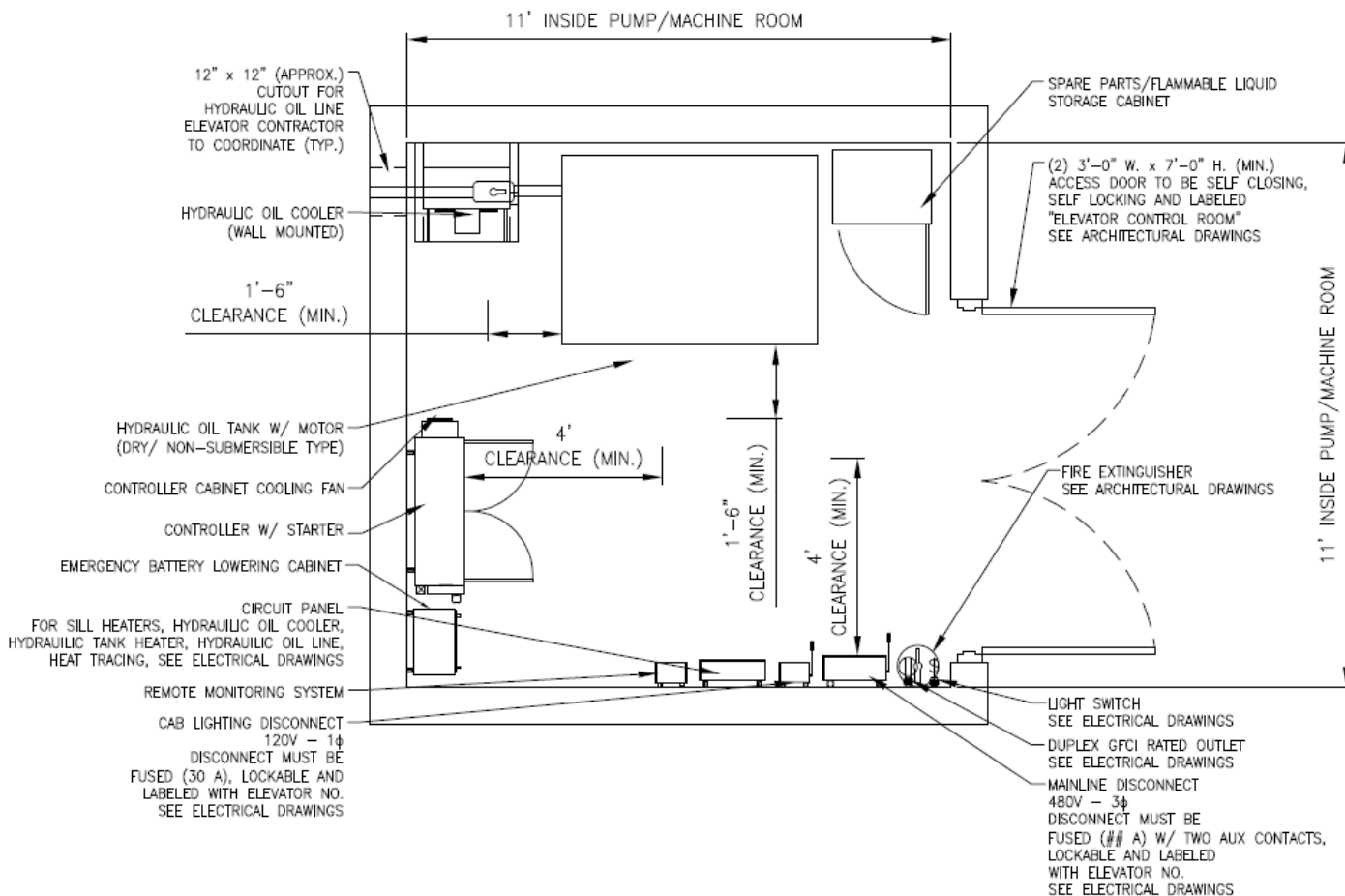

Typical Hydraulic Machine Room Dimensions

9th Edition Advisory Note Appendix A (Part 1)- Hydraulic Machine Rooms: The graphic above represents a 11 x 11 hydraulic elevator machine room that should be utilized when sizing ADA compliant elevators with **Stretcher** requirements.

Room shown above is larger compared to Appendix A (Part 2). Stretcher carrying elevators will necessitate a larger hydraulic tank and motor size.

APPENDIX B – Car Operating Panel Design Requirements

APPENDIX B (Part 1)– Main Car Operating Panel – Typical Low Rise Layout

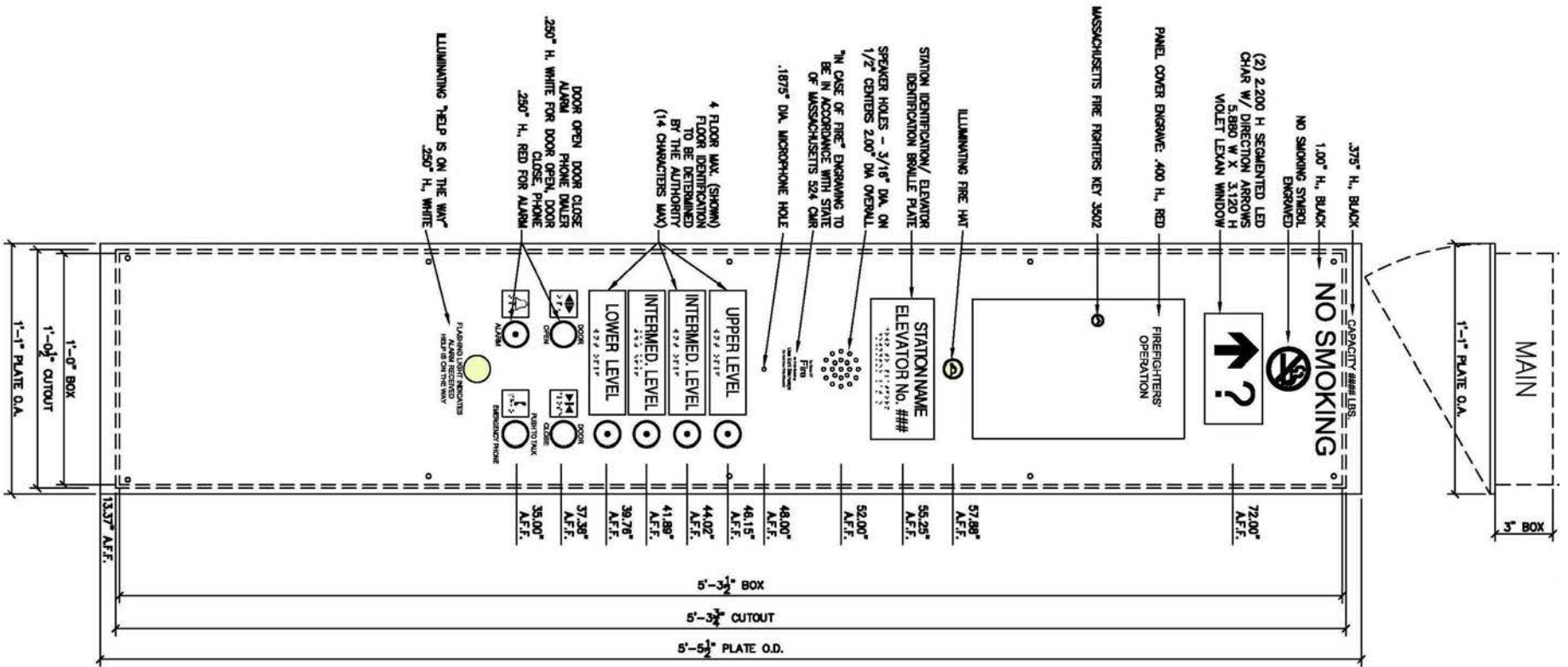

9th edition Advisory Note Appendix B – Car Operating Panel Design Requirements
See ASME A17.1-2004 Table 2.26.12.1 Symbol Identification for more information.
Each car operating panel, main and auxiliary, shall have the main floor denoted with the code required tactile symbol “★”. Note: This has not been added to the typical car operating panel layout since the main floor will vary depending on the location.

APPENDIX B (Part 1) – Main Car Operating Panel Firefighters’ Cabinet – Typical Low Rise Layout

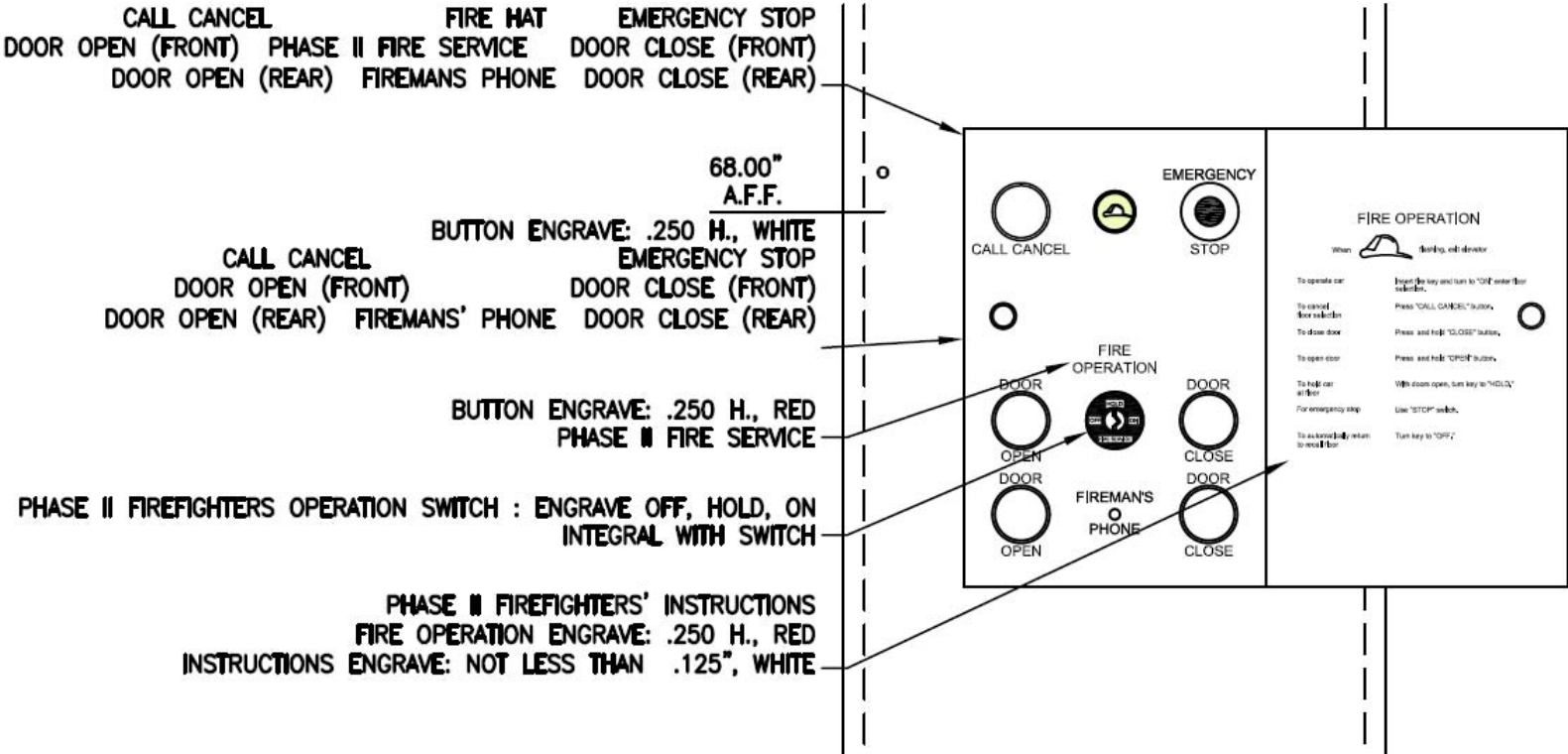

APPENDIX B (Part 1)– Auxiliary Car Operating Panel – Typical Low Rise Layout

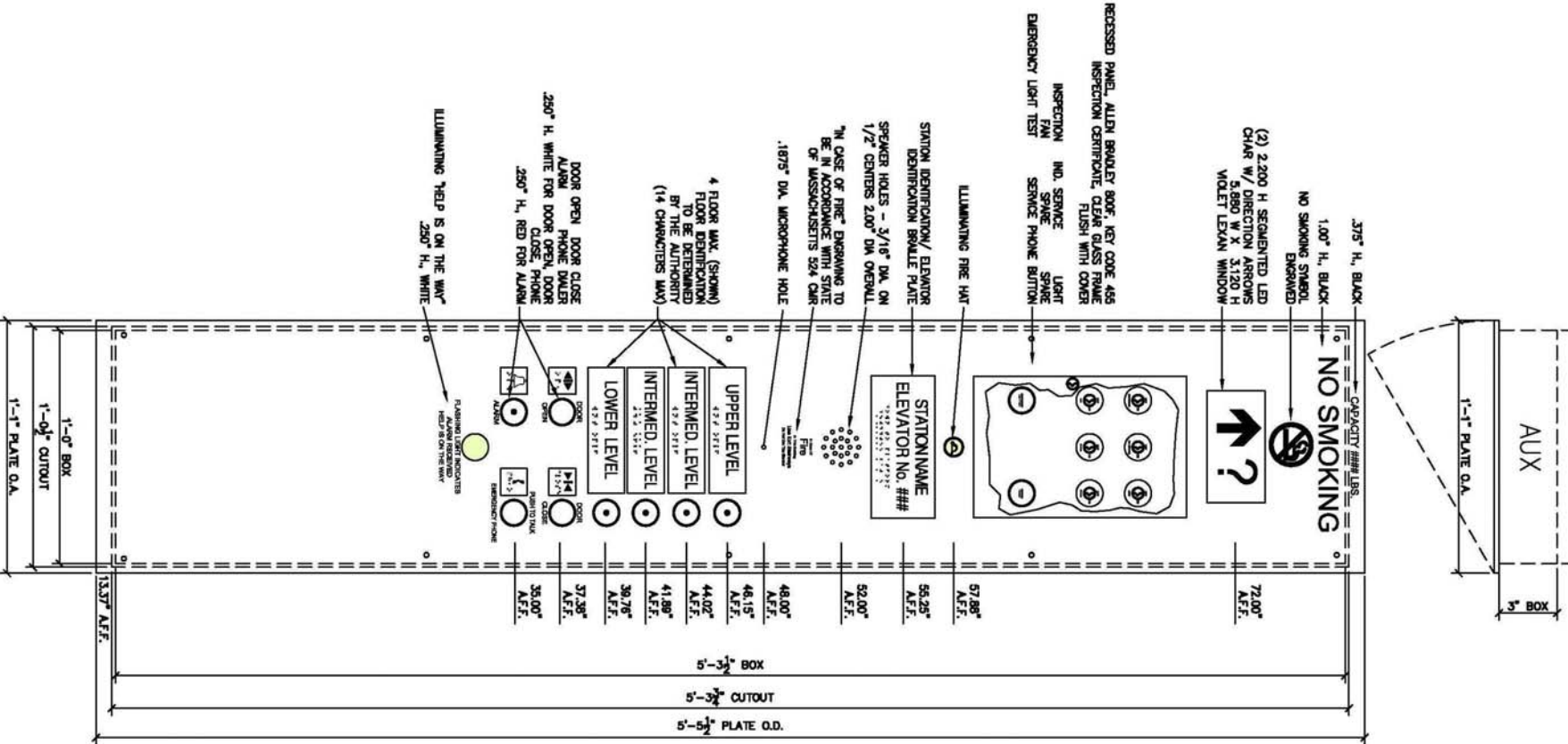

APPENDIX B – Car Operating Panel Design Requirements

APPENDIX B (Part 2)– Main Car Operating Panel – - Typical Mid Rise Layout

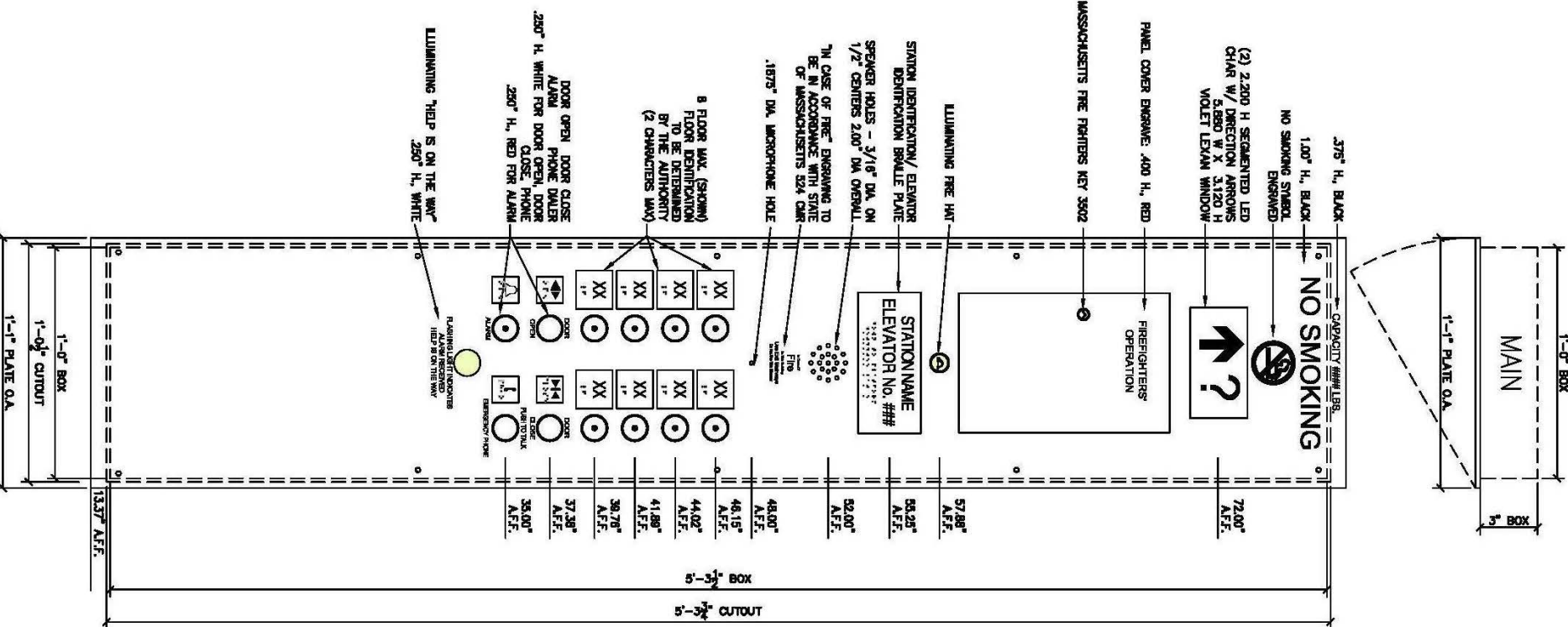

APPENDIX B (Part 2)– Main Car Operating Panel Firefighters’ Cabinet - Typical Mid Rise Layout

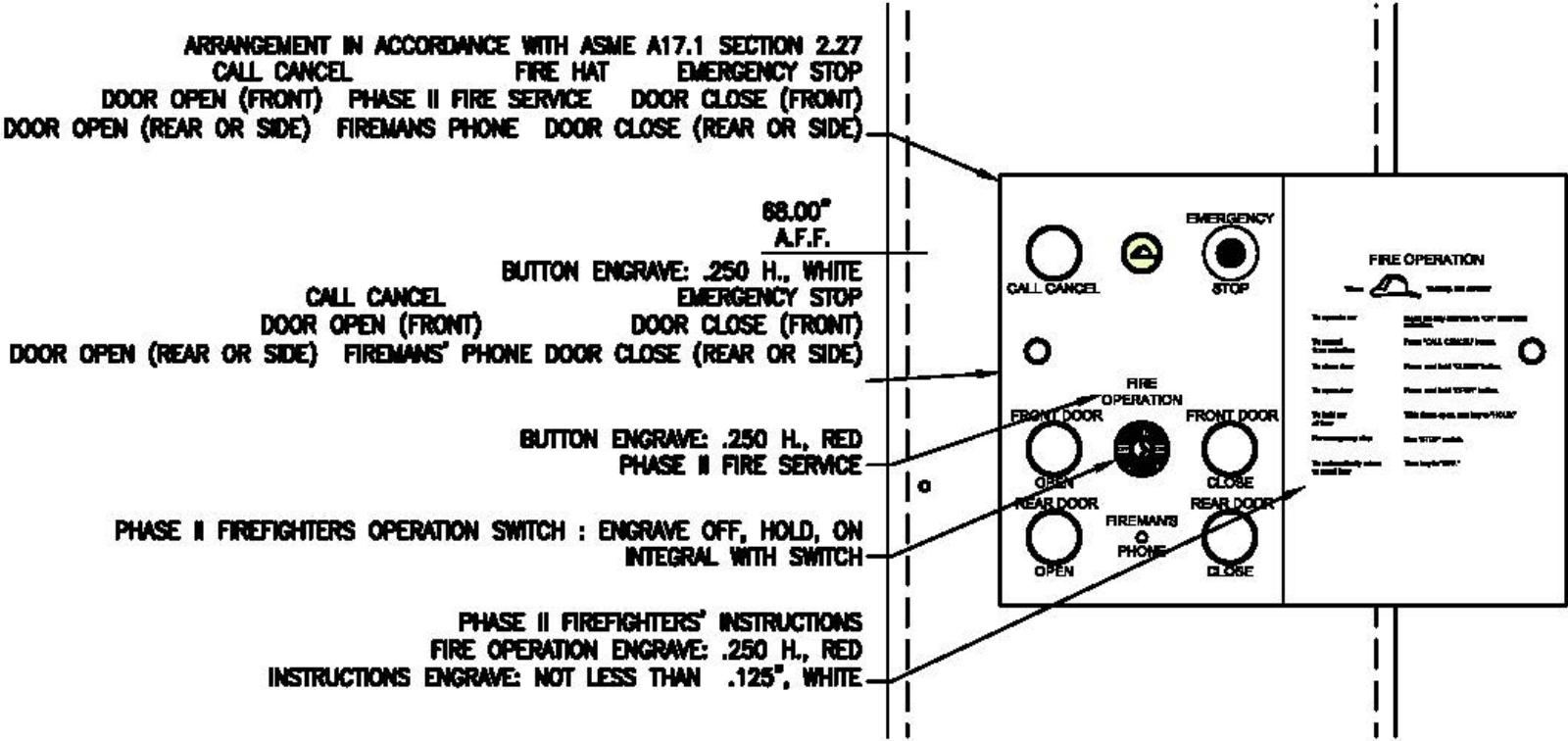

APPENDIX B (Part 2)– Auxiliary Car Operating Panel - Typical Mid Rise Layout

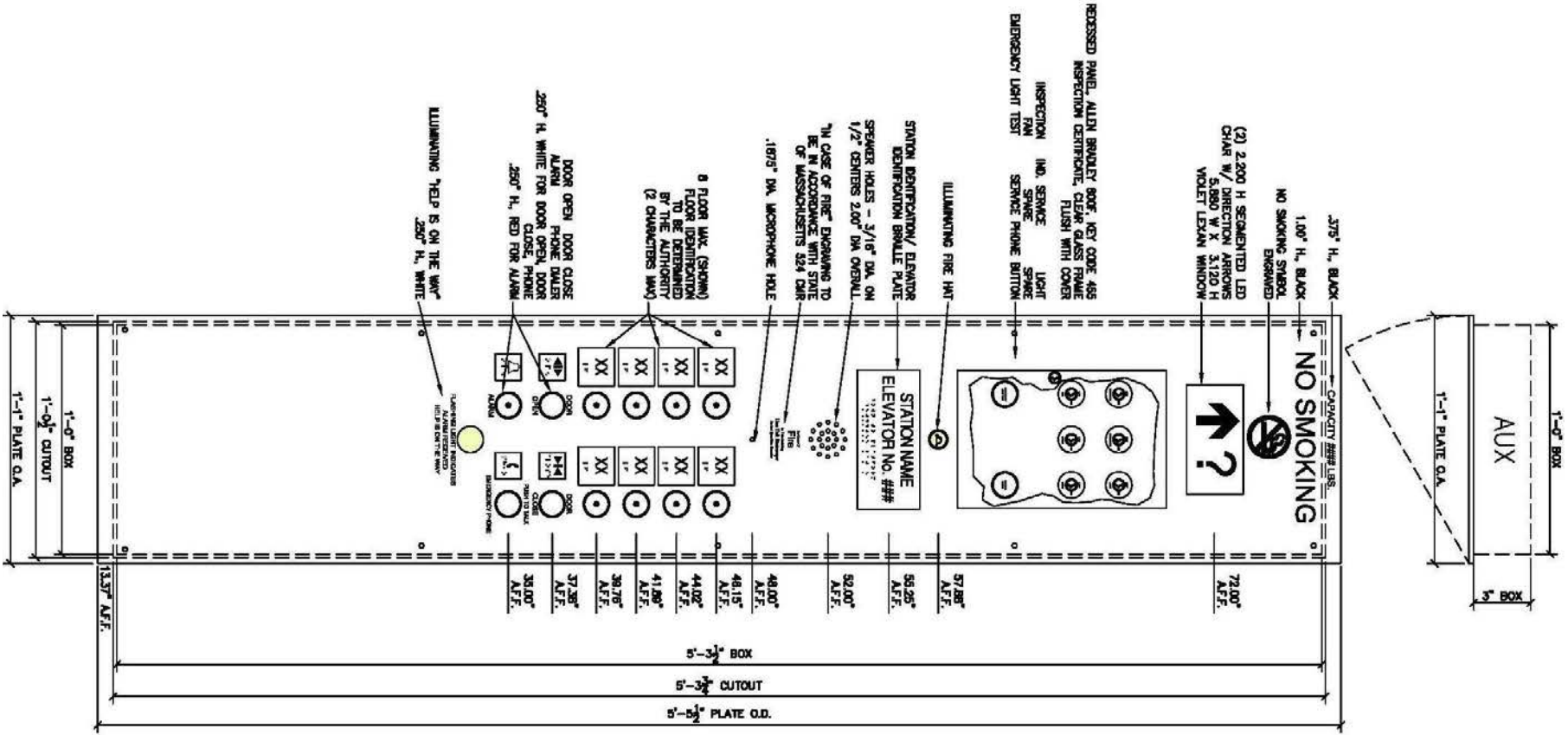

APPENDIX C – Hall Call Station Design Requirements

APPENDIX C (Part 1)– Hall Call Station Upper Level

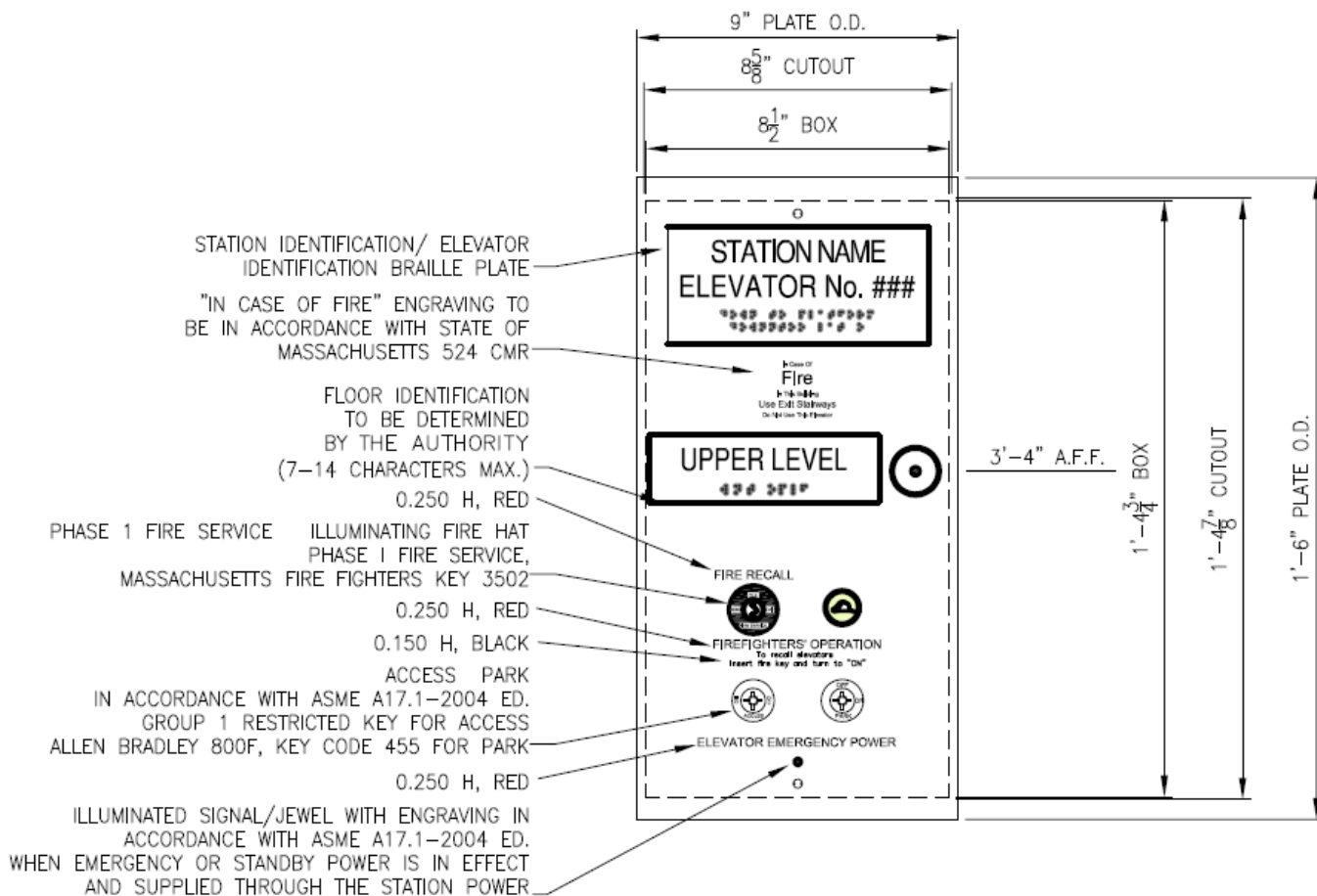

APPENDIX C (Part 2)– Hall Call Station Intermediate Level

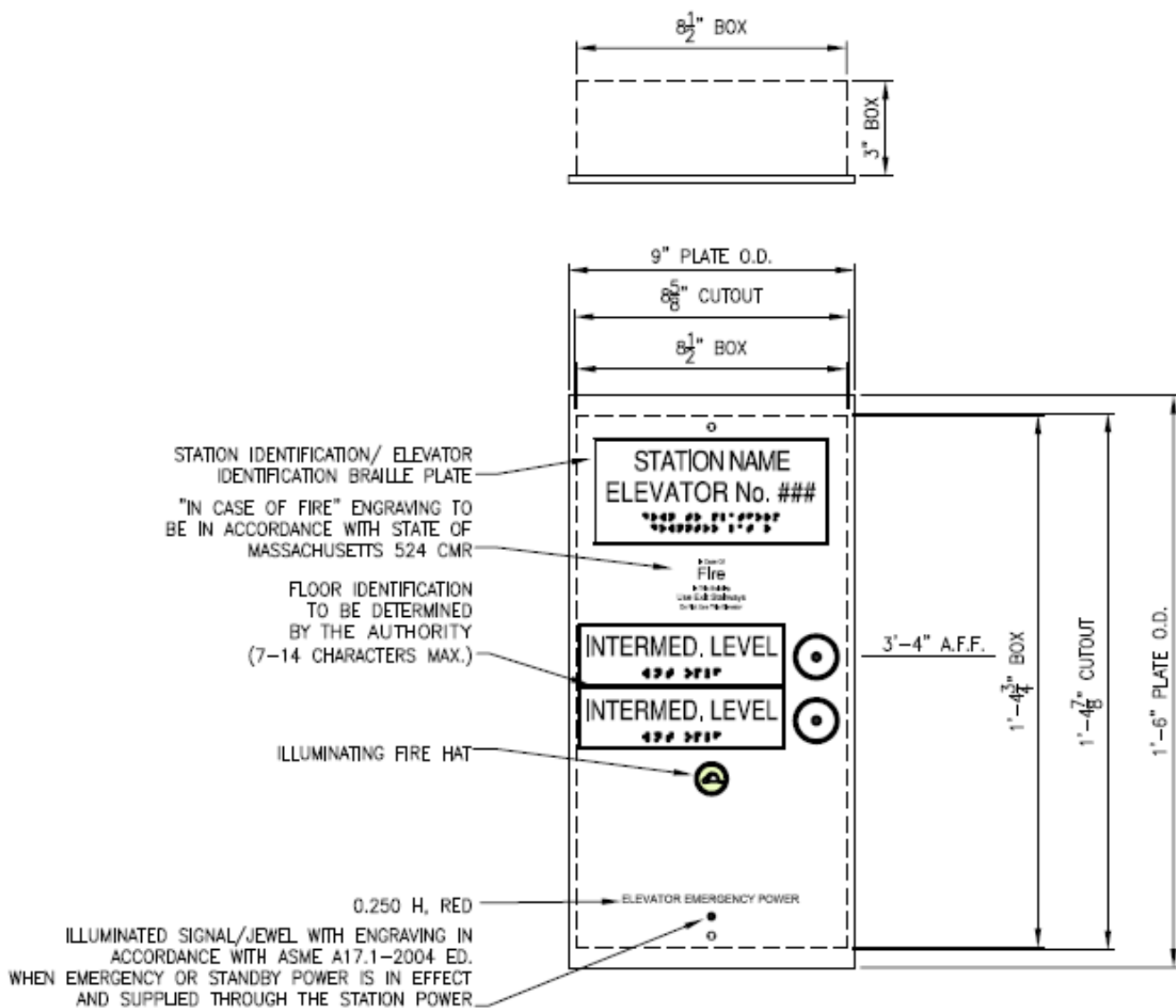

APPENDIX C (Part 3)– Hall Call Station Lower Level

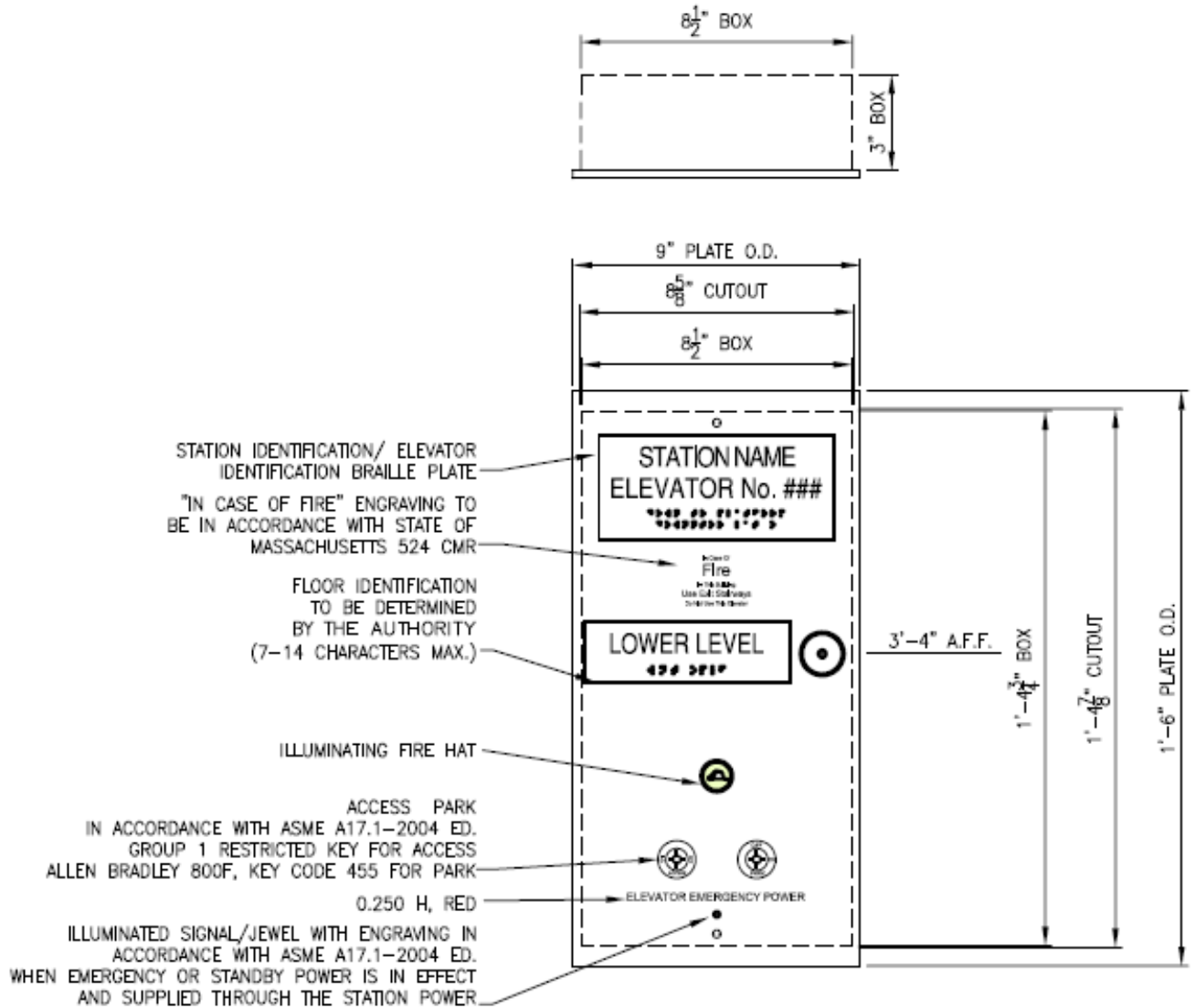

Hall Call Station

9th edition Advisory Note Appendix C- Hall Call Station:

As per IBC-2009 Chapter 10-

1007.8 Two-way communication. A two-way communication system shall be provided at the elevator landing on each *accessible* floor that is one or more stories above or below the *story of exit discharge* complying

with sections 1007.8.1 and 1007.8.2.

Exceptions:

1. Two-way communication systems are not required at the elevator landing where the two-way communication system is provided within *areas of refuge* in accordance with Section 1007.6.3.
2. Two-way communication systems are not required on floors provided with *exit ramps* conforming to the provisions of Section 1010.

As per 780 CMR 8th Edition Chapter 10-

No exceptions or amendments have been made to this rule.

APPENDIX D – Hall Lantern Design Requirements

APPENDIX D (Part 1)– Hall Lantern Upper Level

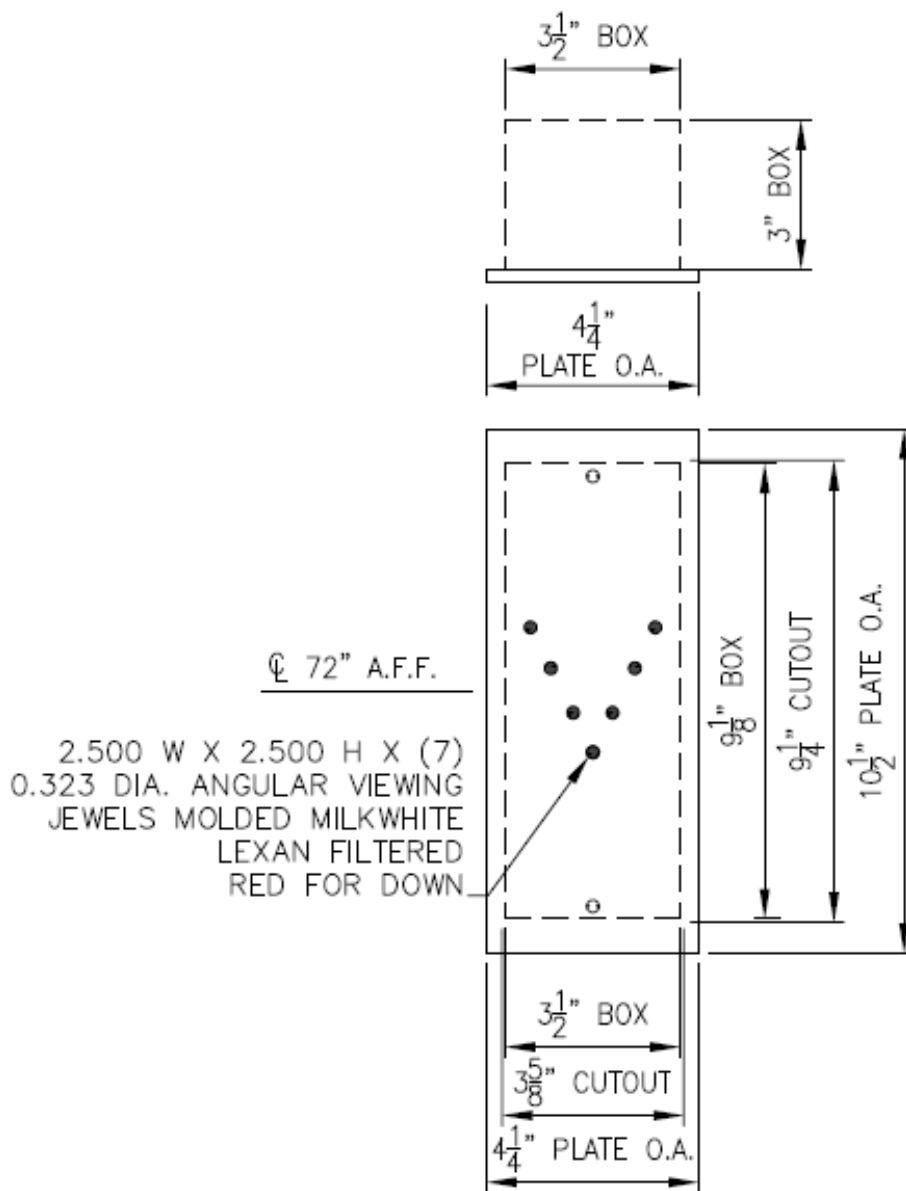

APPENDIX D (Part 2)– Hall Lantern Intermediate Level

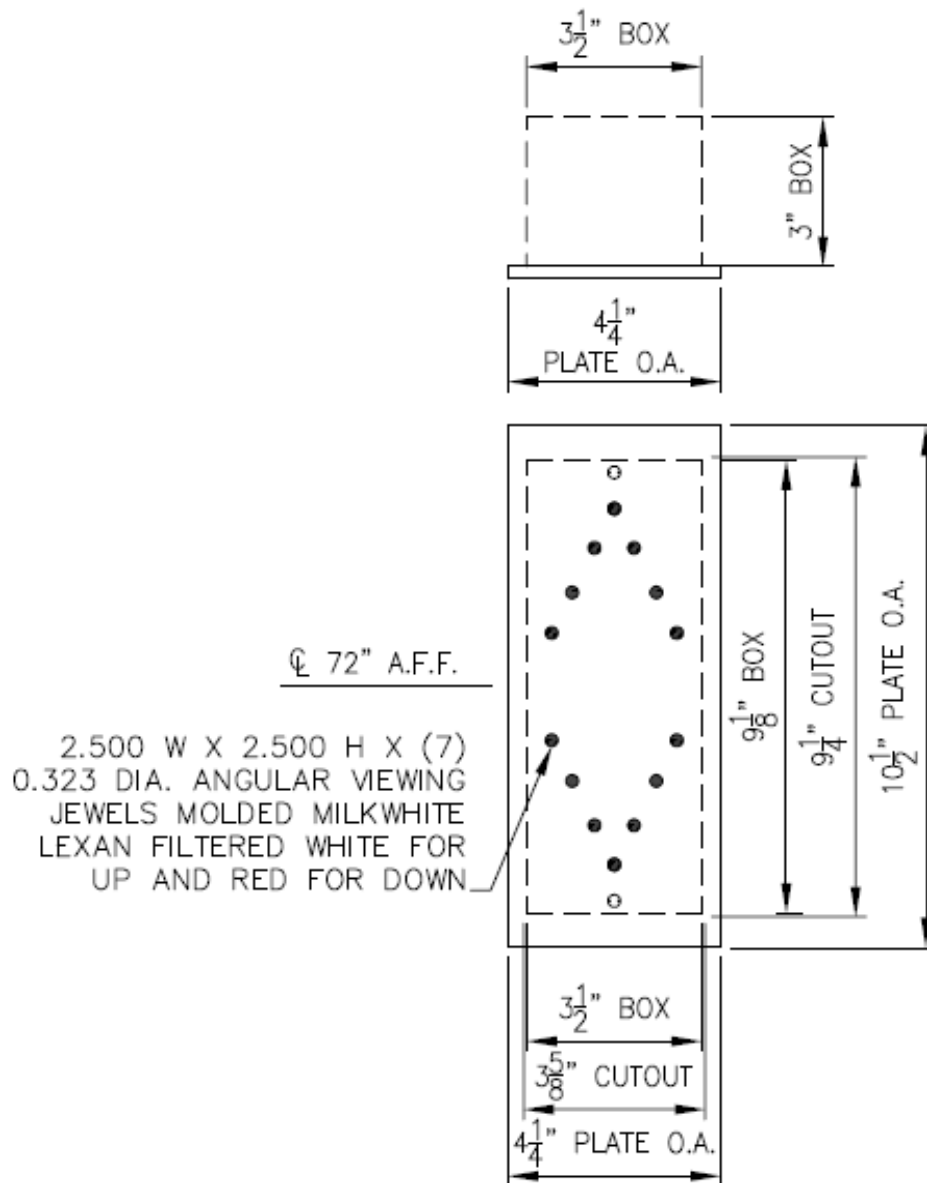

APPENDIX D (Part 3)– Hall Lantern Lower Level

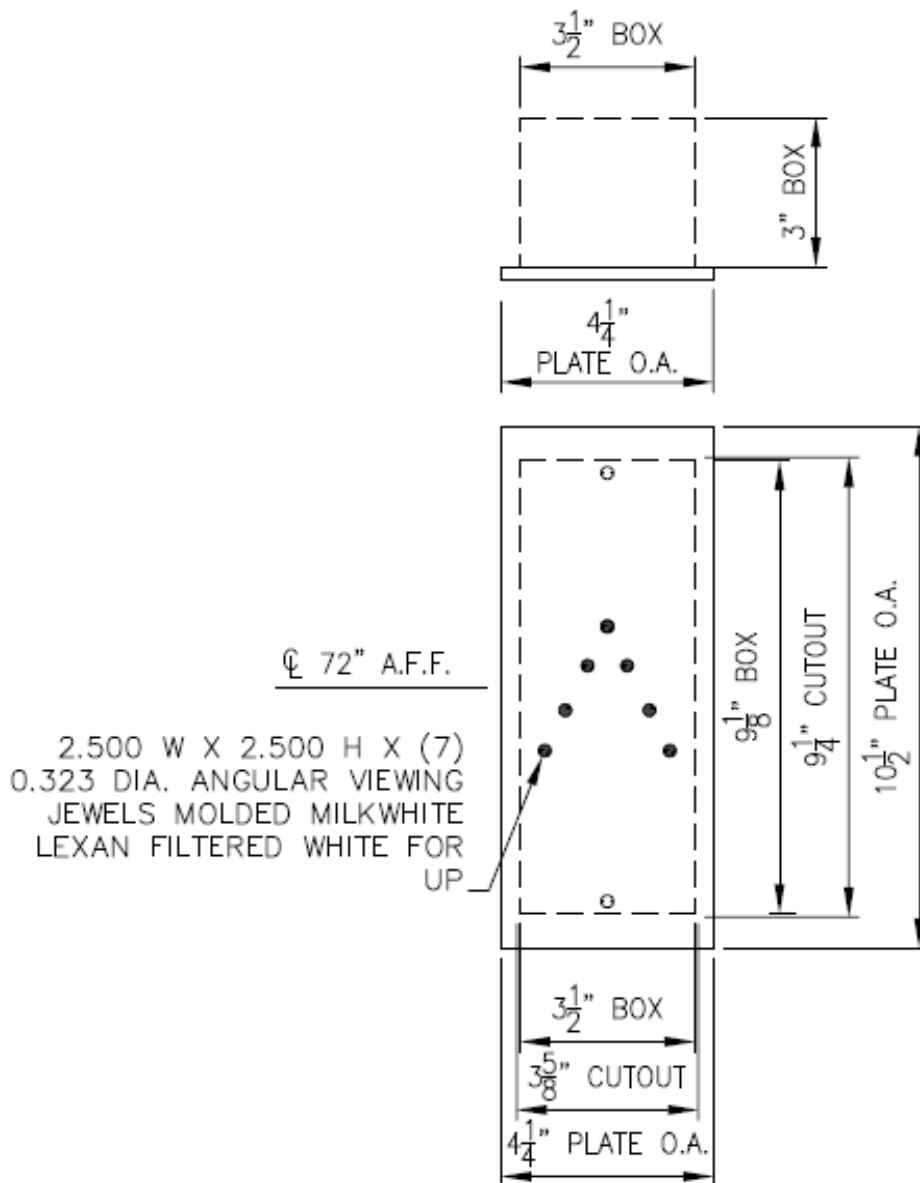

APPENDIX E – Entrance Door Design Requirements
APPENDIX E (Part 1) – Entrance Doors with Full Glass – Option A

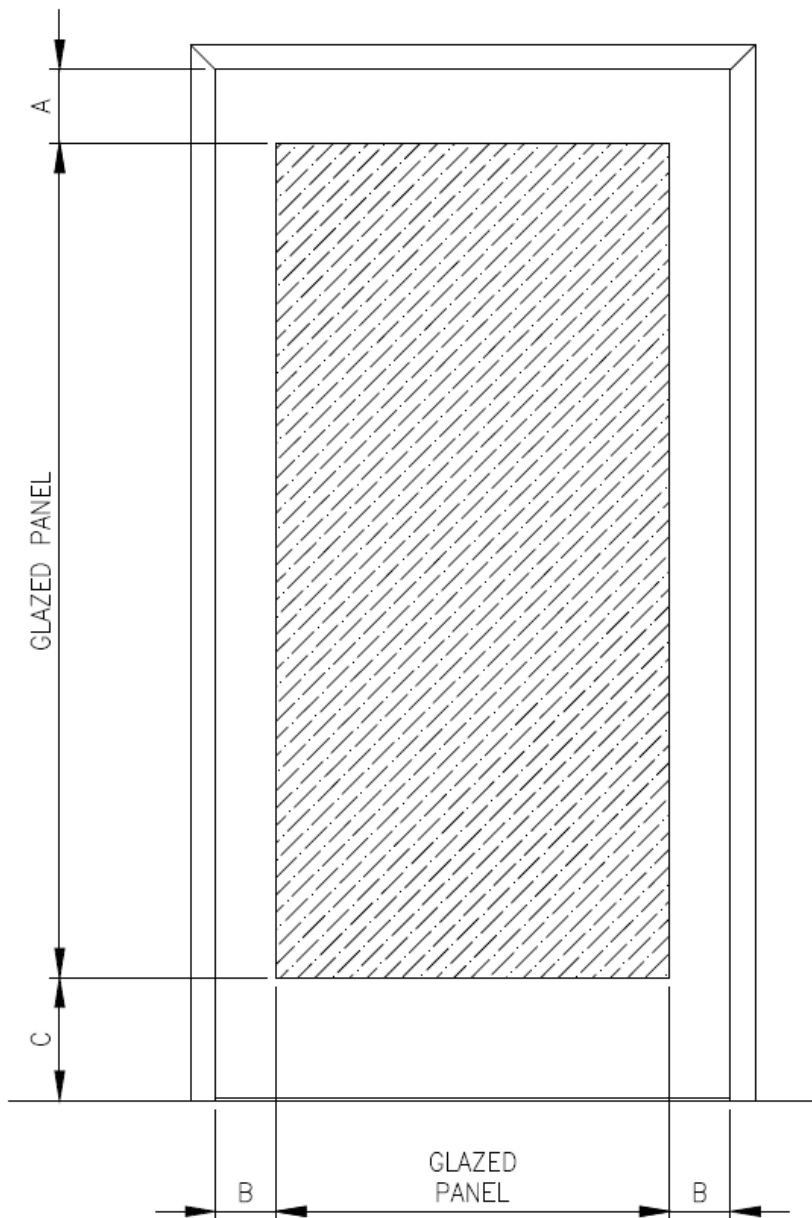

SINGLE SPEED SIDE SLIDE ENTRANCE GLAZED PANEL (60% MIN.)			
DOOR SIZE	A	B	C
36" W. x 84" H.	6"	4"	12"
42" W. x 84" H.	6"	4"	12"
48" W. x 84" H.	6"	5"	12"
NOTE: FOR DOOR HEIGHTS OTHER THAN 84", GLAZED PANEL SIZE AND MULLIONS SHALL BE EVALUATED			

Entrance Doors with Full Glass – Option B

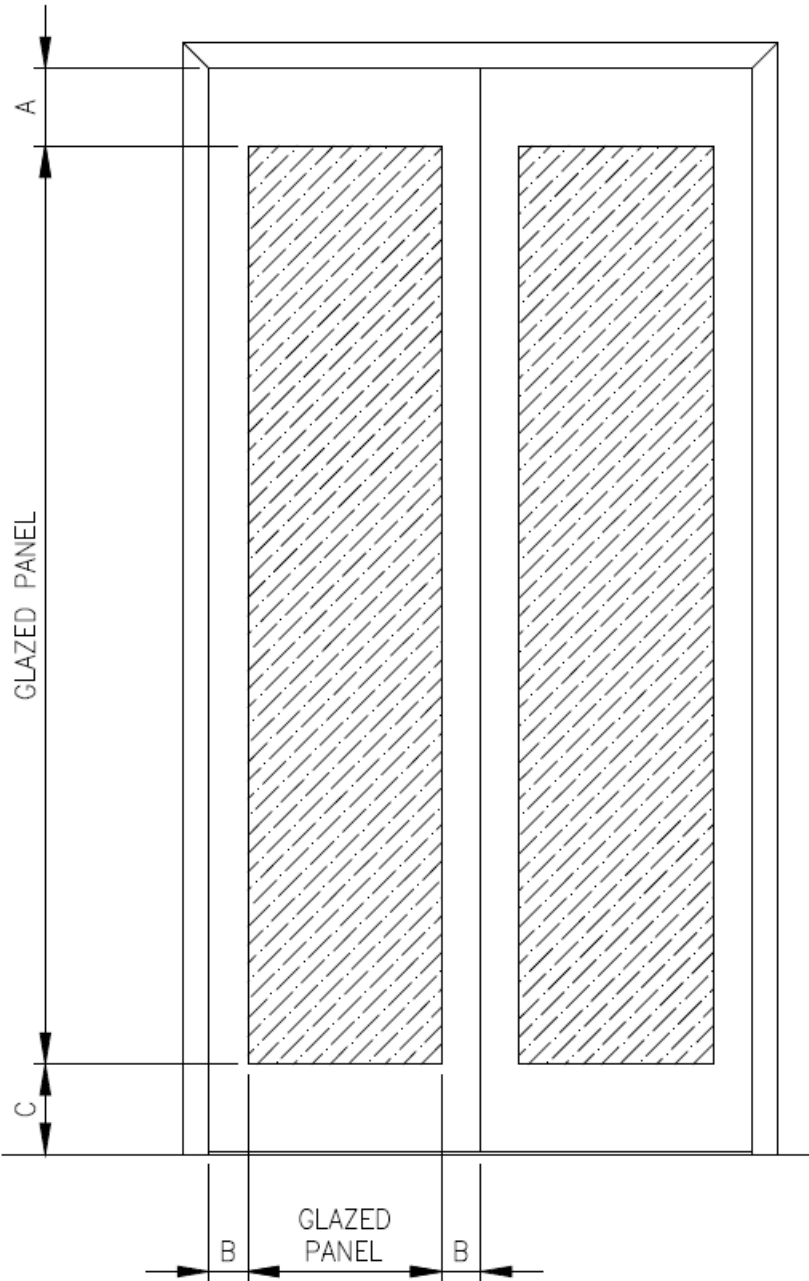

**TWO SPEED SIDE SLIDE ENTRANCE
 GLAZED PANEL (60% MIN.)**

DOOR SIZE	A	B	C
36" W. x 84" H.	4"	3"	4"
42" W. x 84" H.	6"	3"	6"
48" W. x 84" H.	6"	3"	10"
NOTE: FOR DOOR HEIGHTS OTHER THAN 84", GLAZED PANEL SIZE AND MULLIONS SHALL BE EVALUATED			

9th edition Advisory Note Appendix E- Entrance Doors:**As per ASME A17.1-2004 Section 2.11.7.2-**

2.11.7.2 Glass Doors. Where provided, glass hoistway doors shall conform to 2.11.7.2.1 through 2.11.7.2.5

2.11.7.2.1 The glass shall be laminated glass conforming to 16 CFR Part 1201 or CAN/CGSB-12.1. Markings as specified in the applicable standard shall be on each separate piece of glass and shall remain visible after installation.

2.11.7.2.2 The glass shall be not less than 60% of the total visible door panel surface area as seen from the landing side of the doors. Door lap shall not be used in calculating glass size.

2.11.7.2.3 In power-operated doors, the glass panel shall be substantially flush with the surface of the landing side of the door.

2.11.7.2.4 A nonglass edge shall be provided on the leading edge of the door panel.

2.11.7.2.5 The glass door shall conform to 2.11.11.5.7 for horizontally sliding type entrances, 2.11.12.4 for vertically sliding type entrances, or 2.11.13.3 for swinging entrances.

Advisory Note: Depth differences between the glass panel and the stainless steel door frame shall be as flush as possible.

As referenced from ASME A17.1-2004 **2.11.11.5.5**

No areas shall be depressed or raised more than 3 mm (0.125 in.) from the adjacent area and edges shall be beveled at not more than 30 deg to the panel surface.

APPENDIX E (Part 2)– Entrance Doors with Vision Panels

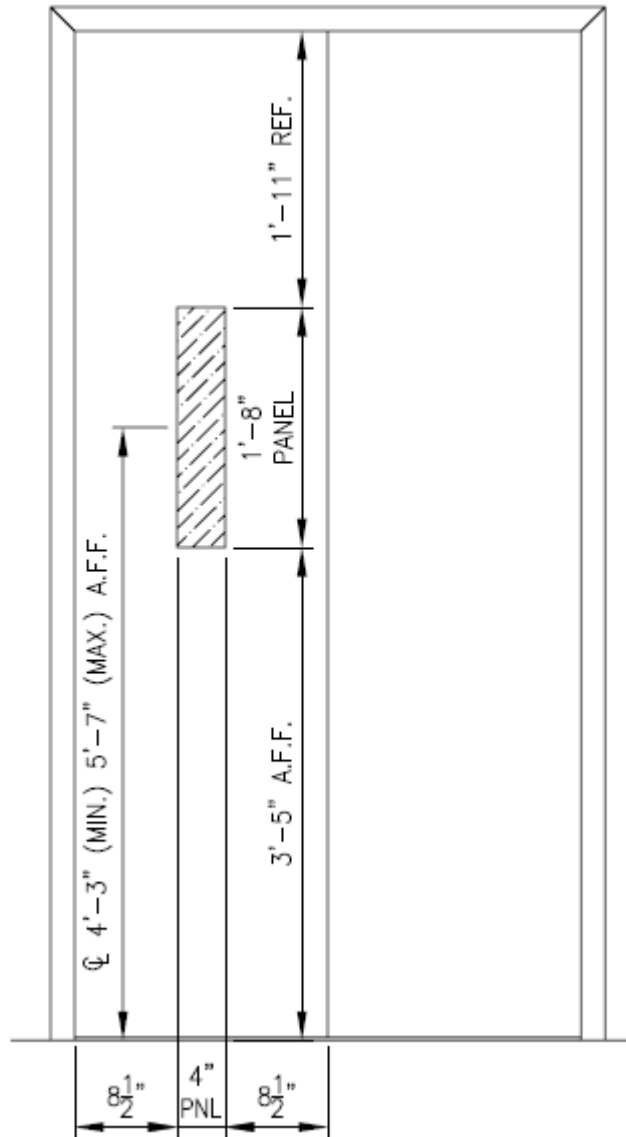

**Entrance Doors with Vision Panel
 80 Sq. In. (shown)
 (24 Sq. In (min.), 85 Sq. In. (max.)
 (Option A)**

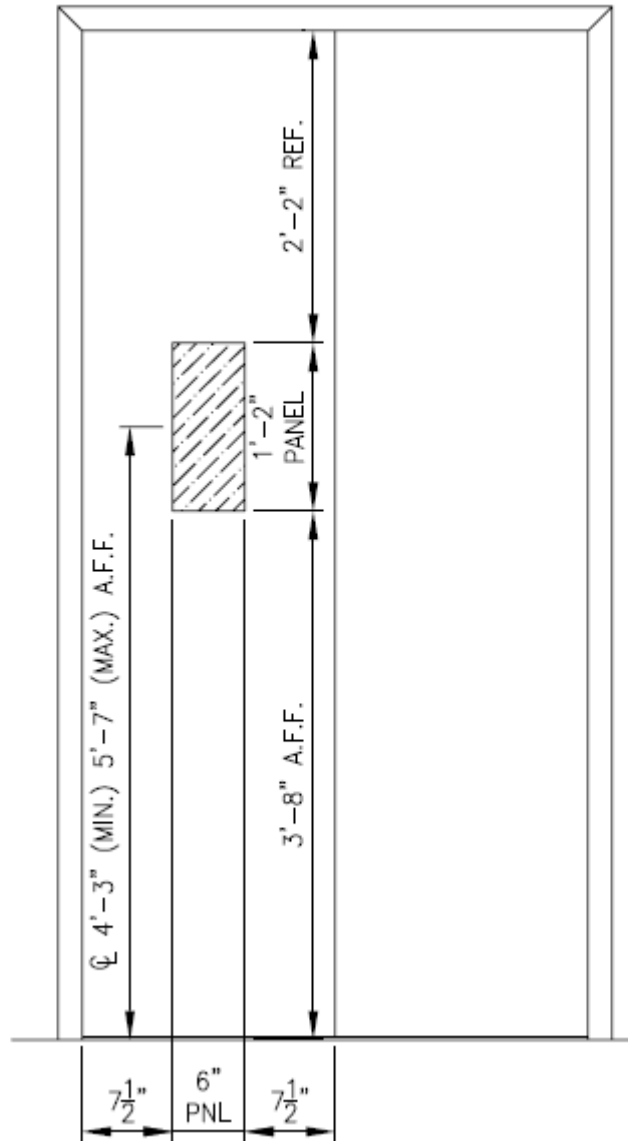

Entrance Doors with Vision Panel
84 Sq. In. (shown)
(24 Sq. In (min.), 85 Sq. In. (max.)
(Option B)

Elevator Entrance Doors with Vision Panels

9th edition Advisory Note Appendix E- Entrance Doors:

As per ASME A17.1-2004 Section 2.11.7.1-

2.11.7.1 Vision Panels. Manually operated or self closing hoistway doors of the vertically or horizontally sliding type, for elevators with automatic or continuous pressure operation, shall be provided with a vision panel. Vision panels shall not be required at landings of automatic operation elevators where a hall position indicator is provided. In multisection doors, the vision panel is required in one section only, but is permitted to be placed in all sections. All horizontally swinging elevator doors shall be provided with vision panels. Vision panels are permitted for any type of hoistway door. Where required or used, vision panels shall conform to 2.11.7.1.1 through 2.11.7.1.7.

2.11.7.1.1 The area of any single vision panel shall be not less than 0.015 m² (24 in.²), and the total area of one or more vision panels in any hoistway door shall be not more than 0.055 m² (85 in.²).

2.11.7.1.2 Each clear panel opening shall reject a ball 150 mm (6 in.) in diameter.

2.11.7.1.3 Muntins used between panel sections shall be of noncombustible material and of substantial construction.

2.11.7.1.4 Panel opening shall be glazed with either of the following: (a) clear wire glass not less than 6 mm (0.25 in.) (b) other transparent glazing material not less than 6 mm (0.25 in.) thick that meets the impact safety standard 16 CFR Part 1201 or CAN/CGSB-12.1, CAN/ CGSB-12.11, or CAN/CGSB-12.12, whichever is applicable (see Part 9)

2.11.7.1.5 The center of the panel shall be located not less than 1 300 mm (51 in.) and not more than 1 700 mm (67 in.) above the landing, except that for vertically sliding biparting counterbalanced doors, it shall be located to conform to the dimensions specified in so far as the door design will permit.

2.11.7.1.6 Vision panels in power-operated doors shall be substantially flush with the surface of the landing side of the door

2.11.7.1.7 Vision panels shall be protected by protective grilles made of steel not less than 1.4 mm (0.055 in.) thick, in accordance with the following specifications: (a) Grilles shall be sized to fit within or over the vision panel frame and completely cover the vision panel opening in the hoistway door (b) Grilles shall be secured by means that deter removal by common tools. (c) Grilles shall contain openings that shall be not larger than 19 mm _ 19 mm (0.75 in. _ 0.75 in.) in diameter. Such openings shall be spaced at 25 mm(1 in.) center-to-center. (d) Grille edges shall be free of burrs and beveled. (e) Grilles shall be installed on the hoistway side of the door.

APPENDIX F – Elevator Cab Door Design Requirements

APPENDIX F (Part 1)– Elevator Cab Door with Full Glass – Option A

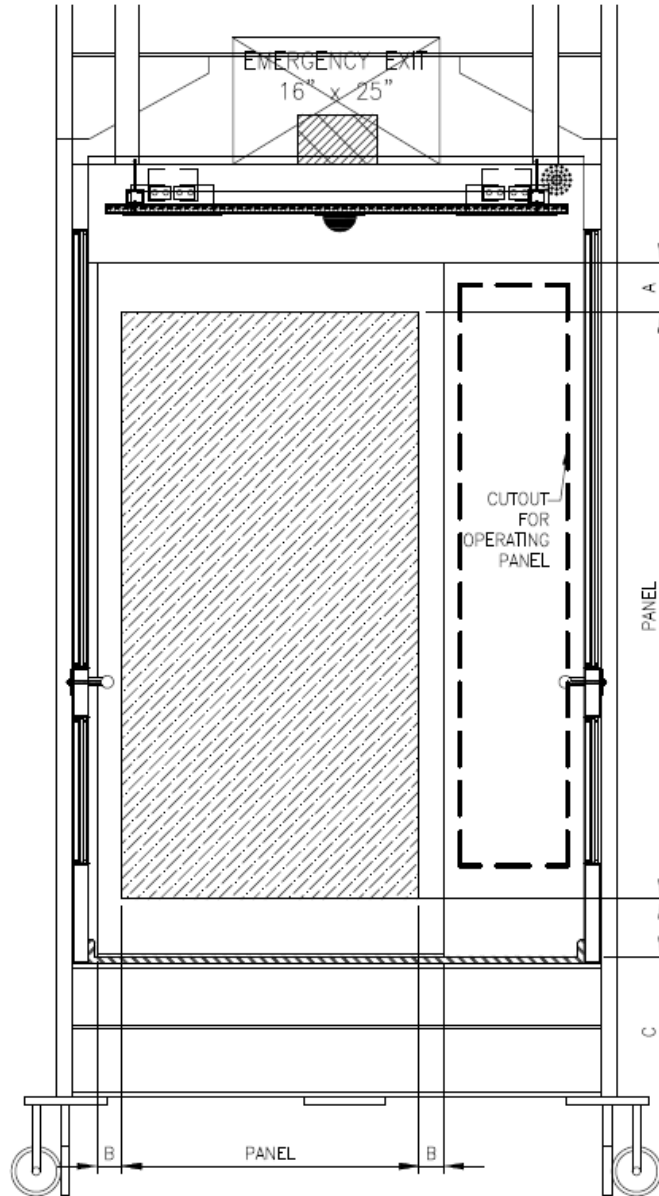

SINGLE SPEED SIDE SLIDE GLAZED DOOR PANEL (60% MIN.)			
DOOR SIZE	A	B	C
36" W. x 84" H.	6"	4"	12"
42" W. x 84" H.	6"	4"	12"
48" W. x 84" H.	6"	5"	12"
NOTE: FOR DOOR HEIGHTS OTHER THAN 84", GLAZED PANEL SIZE AND MULLIONS SHALL BE EVALUATED			

Elevator Cab Door with Full Glass – Option B

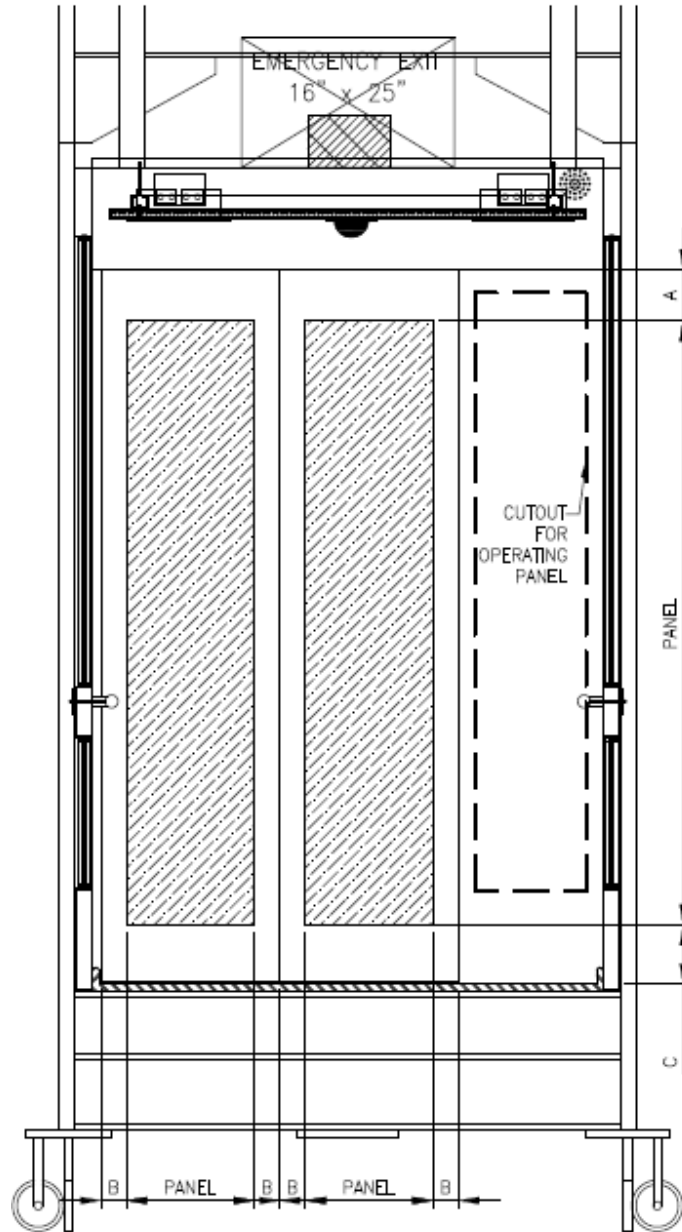

TWO SPEED SIDE SLIDE GLAZED DOOR PANEL (60% MIN.)			
DOOR SIZE	A	B	C
36" W. x 84" H.	4"	3"	4"
42" W. x 84" H.	6"	3"	6"
48" W. x 84" H.	6"	3"	10"
NOTE: FOR DOOR HEIGHTS OTHER THAN 84", GLAZED PANEL SIZE AND MULLIONS SHALL BE EVALUATED			

9th edition Advisory Note Appendix F- Elevator Cab Doors:**As per ASME A17.1-2004 Section 2.14.5.8.-**

2.14.5.8.2 Glass doors, where provided, shall conform to the following requirements:

- (a) The glass shall be laminated glass conforming to the requirements of ANSI Z97.1, or 16 CFR Part 1201, or be laminated glass, safety glass, or safety plastic conforming to the requirements of CAN/CGSB-12.1, whichever is applicable (see Part 9). Markings as specified shall be on each separate piece, and shall remain visible after installation.
- (b) The glass shall be not less than 60% of the total visible door panel surface area as seen from the car side of the doors. Door lap shall not be used in calculating glass size.
- (c) In power-operated doors, the glass panel shall be substantially flush with the surface of the car side of the door.
- (d) The glass shall conform to the applicable strength requirements of 2.14.4.6.
- (e) The glass shall be so mounted that it, and its mounting structure, will withstand the required elevator tests without becoming damaged or dislodged.
- (f) A nonglass edge shall be provided on the leading edge of the door panel.

APPENDIX F (Part 2)– Elevator Cab Door with Vision Panels

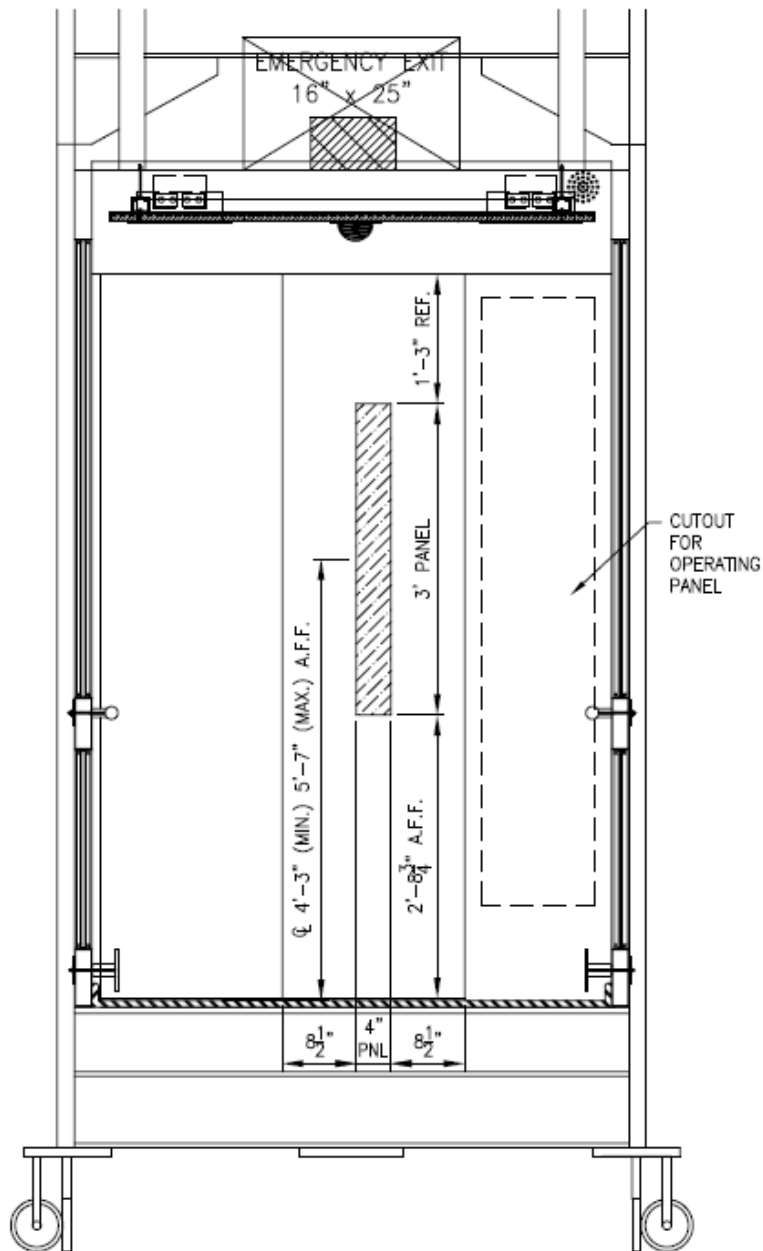

Elevator Cab Doors with Vision Panel
144 Sq. In. (shown)
155 Sq. In (max.)
(Option A)

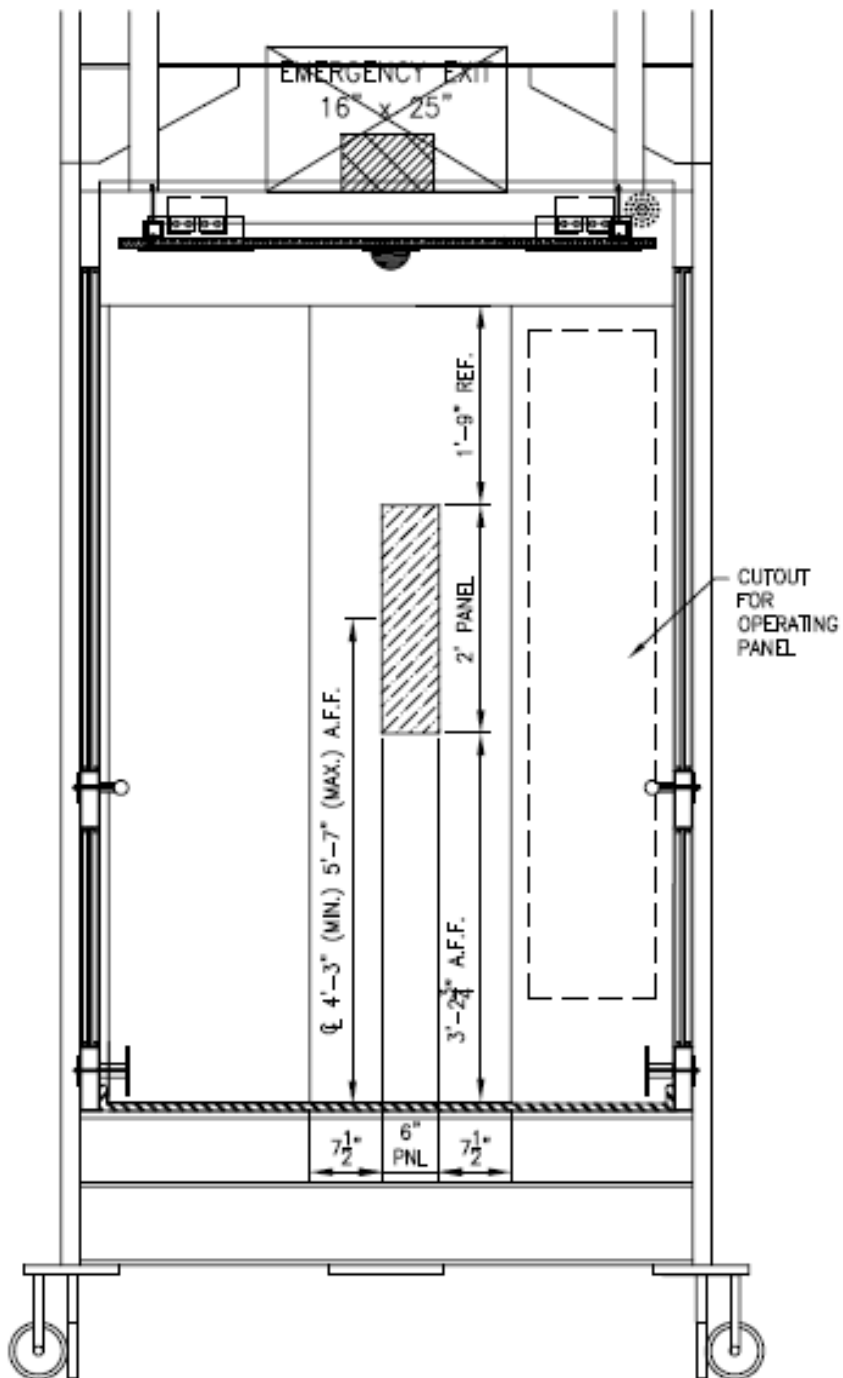

Elevator Cab Doors with Vision Panel (Option B)
144 Sq. In. (shown)
155 Sq. In (max.)
(Option B)

Elevator Cab Doors with Vision Panel

9th edition Advisory Note Appendix F- Elevator Cab Doors:

As per ASME A17.1-2004 Section 2.14.2.5-

2.14.2.5 Vision Panels. Vision panels are not required, but where used, shall

(a) be of a total area of not more than 0.1 m² (155 in.²) and contain no single glass panel having a width exceeding 150 mm (6 in.).

(b) be provided with wire-glass panels or laminated glass panels conforming to 16 CFR Part 1201 or CAN/ CGSB-12.11, whichever is applicable (see Part 9). Markings as specified in the applicable standard shall be on each separate piece of laminated glass, and shall remain visible after installation.

(c) be located in the car door or in the front return panel of the car enclosure.

(d) have the inside face of a car door vision panel, grille, or cover located substantially flush with the inside surface of the car door.

(e) have fasteners that are located on the hoistway side. It shall not be possible to remove the fasteners with common tools.

APPENDIX G – Elevator Cab Lighting Design Requirements

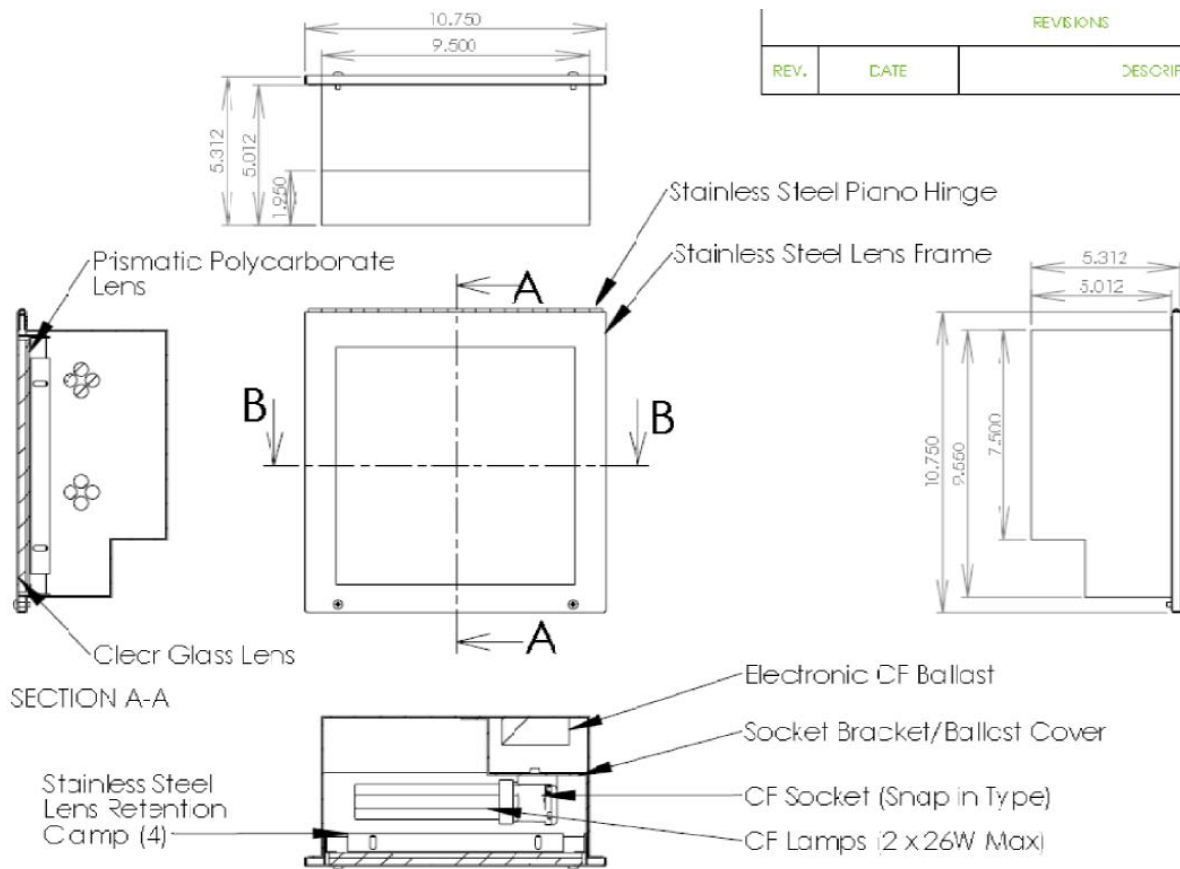

APPENDIX H – Elevator Related Signage Design Requirements

APPENDIX H (Part 1) – Single Elevator with Signage

Single Elevator Option 1 – Out of Service Sign Adjacent to Hall Station

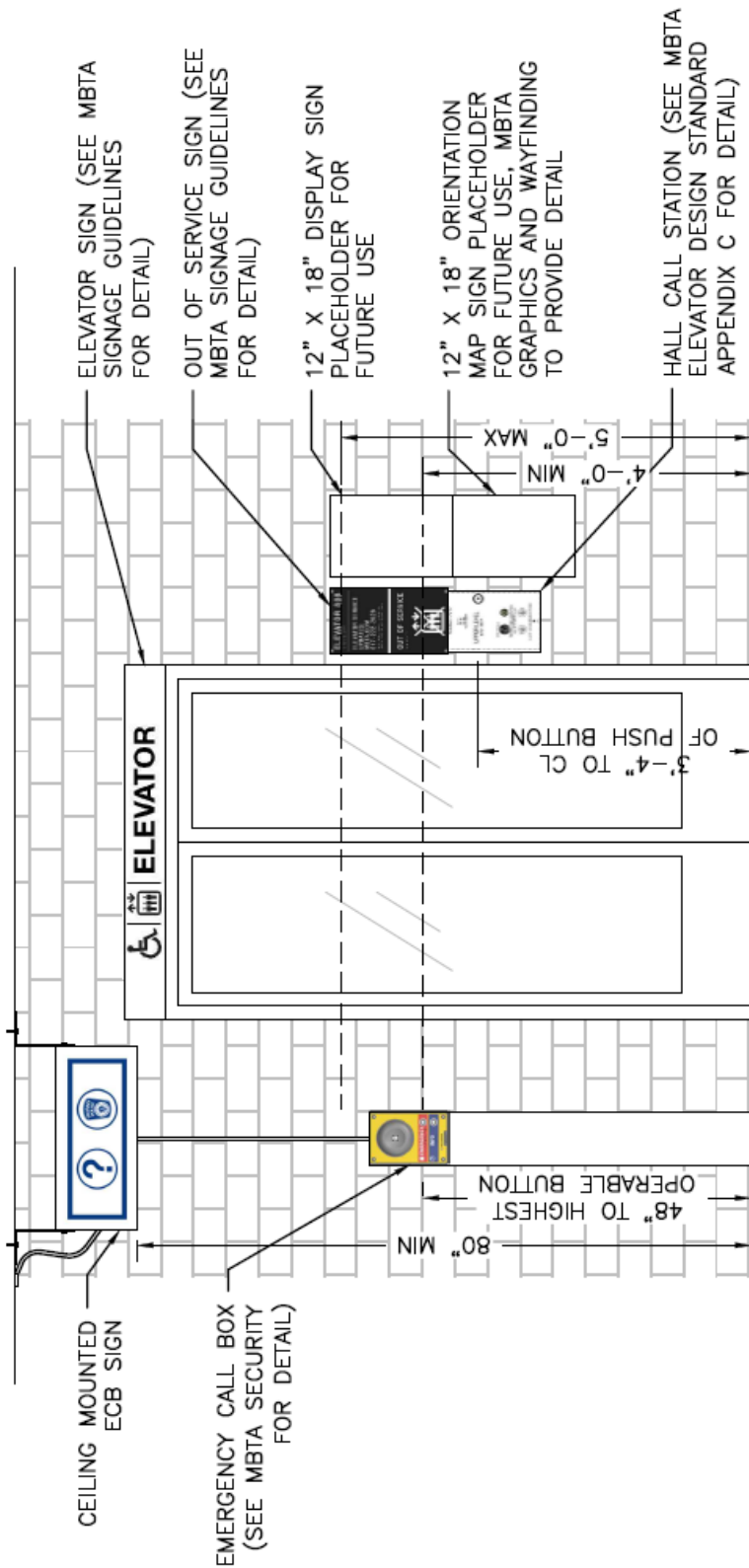

Single Elevator Option 2 – Out of Service Sign Opposite Side of Entrance from Hall Station

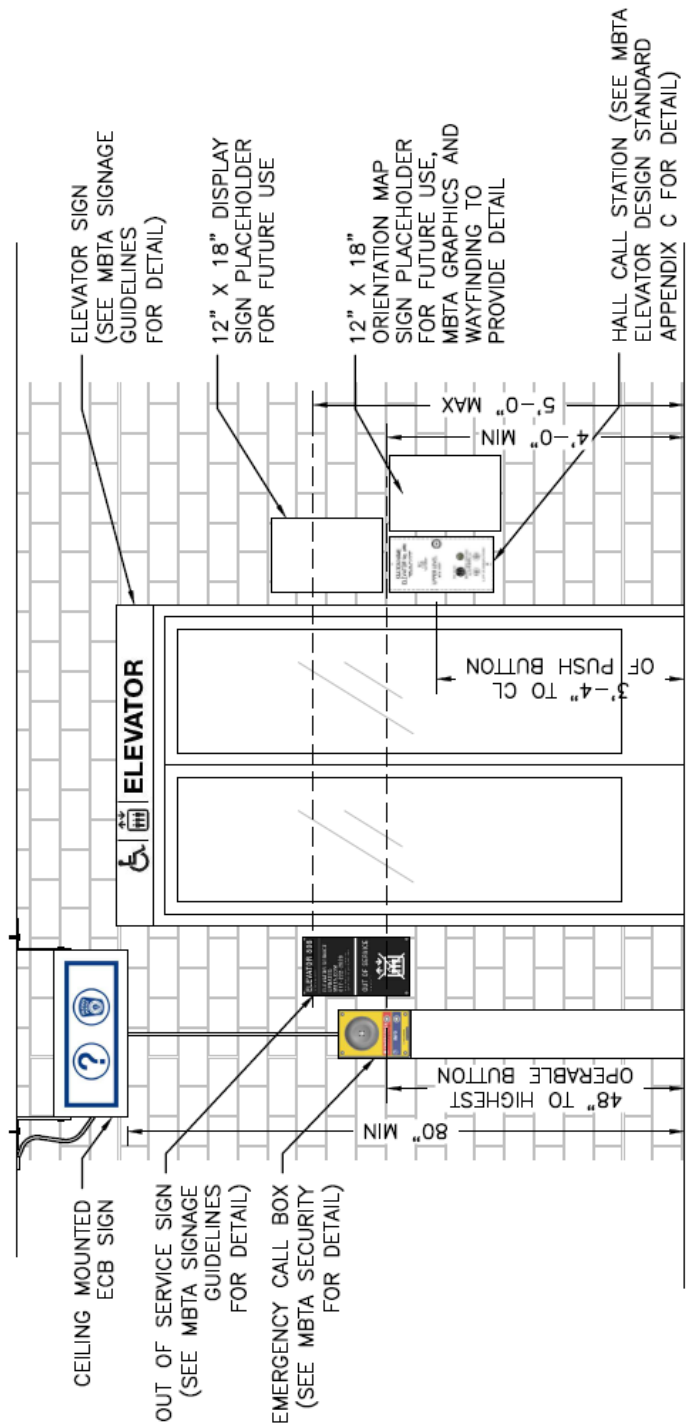

APPENDIX H (Part 2) – Duplex Elevators with Signage Duplex Elevator Option 1 (larger distance between doors)

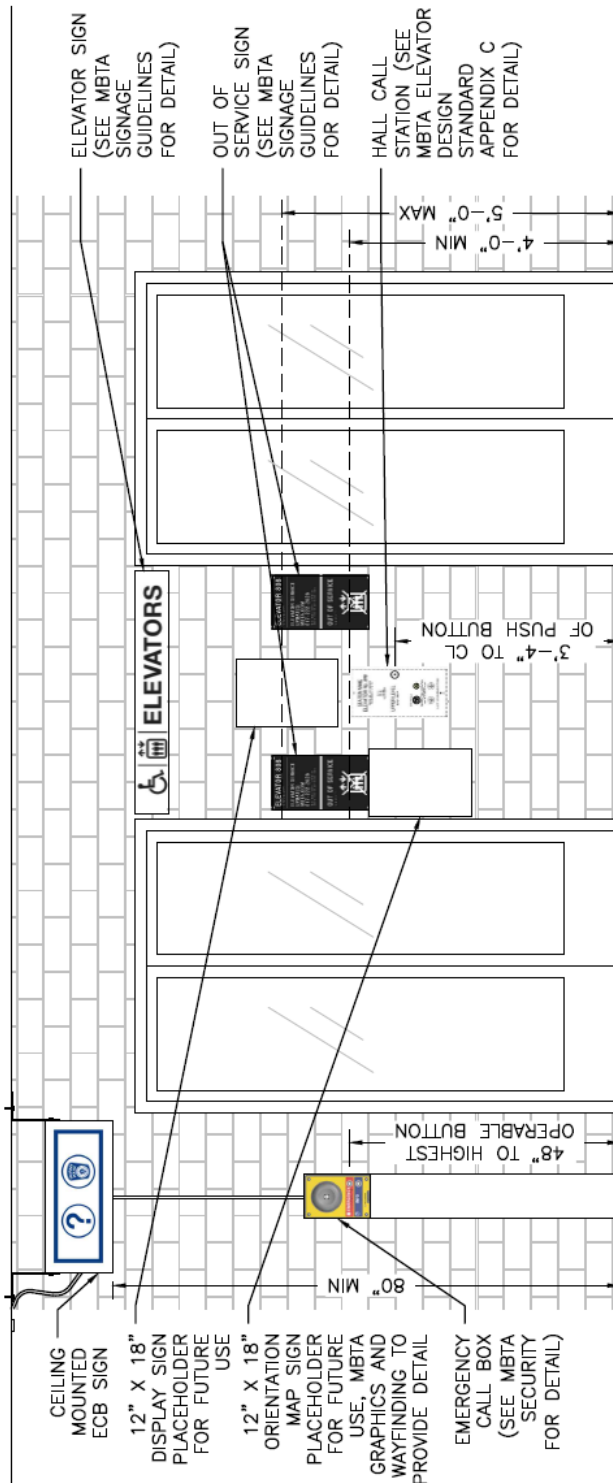

Duplex Elevator Option 1 (smaller distance between doors)

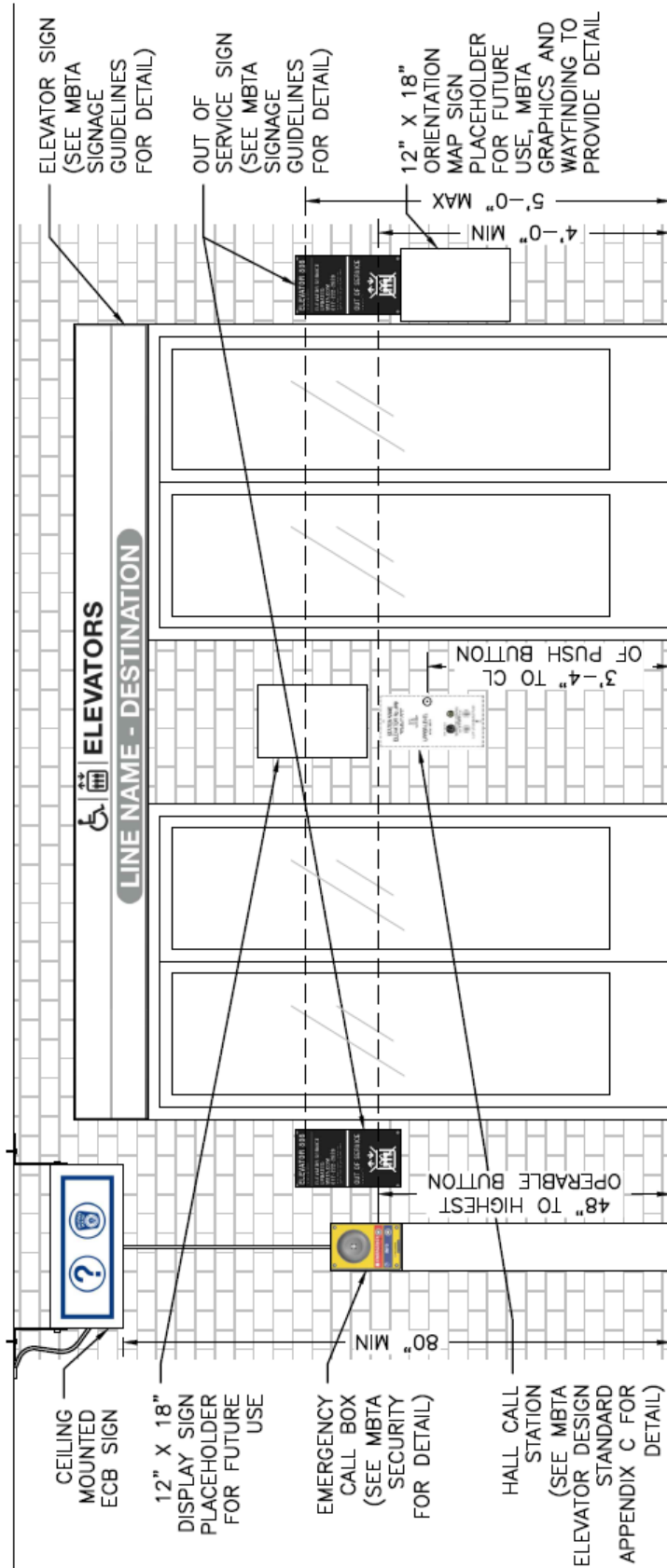

APPENDIX H (Part 3) – Signage Details and Requirements

Scope

Designer shall contact MBTA Graphics and Wayfinding for direction and coordination on signing to and at elevators. MBTA to provide graphics for all signs, including tactile Braille signs.

Elevator Entrance Sign

Option 1



OR



Elevator Entrance Sign Option 1

Note: An elevator sign will appear above any elevator in the station. Use the term “ELEVATOR” or “ELEVATORS” in conjunction with the ISA and Elevator icons to indicate the presence of an elevator. Sign shall be 6”H.

Option 2



OR



Elevator Entrance Sign Option 2

Note: If multiple elevators are present within a space and the destination of the elevator is not clearly indicated with adjacent wayfinding signage, the sign above the elevator will also indicate the destination that the elevators serves on a panel below the “ELEVATOR” or “ELEVATORS”, ISA and Elevator icons. Sign shall be 12”H.

Elevator Out of Service Sign



Elevator Out of Service Sign

Note: Flip sign. Mounted adjacent to elevator door opening. One per Elevator opening. Elevator Number to be included and approved by MBTA. MBTA Graphics and Wayfinding to provide sign graphics files. Out of Service sign dimensions are 9.5" W x 8.5" H when closed and 9.5"W x 17" H when opened.

Placeholder for Future Use Display/Sign

Note: A space shall be provided for future use by a display/sign as determined by MBTA Graphics and Wayfinding. The placeholder shall be 12" W x 18" H. The location of the placeholder shall be located above or adjacent to the elevator hall station. In a duplex, the placeholder shall be more centrally located between the two elevator entrances as possible. MBTA Graphics and Wayfinding to provide the sign graphics files for construction drawings and production to designer as required. If MBTA Graphics and Wayfinding do not currently require a display/sign then a placeholder shall be provided for future use.

Orientation Map Sign

Note: Each elevator lobby shall be provided an orientation map. The orientation map shall provide a graphic depiction of the cab and station floor plans to aide customers in orientation within stations. The placeholder shall be 12" W x 18" H. The location of the placeholder shall be located above or adjacent to the elevator hall station. MBTA Graphics and Wayfinding to provide the sign graphics files for construction drawings and production.

Elevator Pump/Machine Room Signage

Elevator Machine Room Sign (For All Elevators)

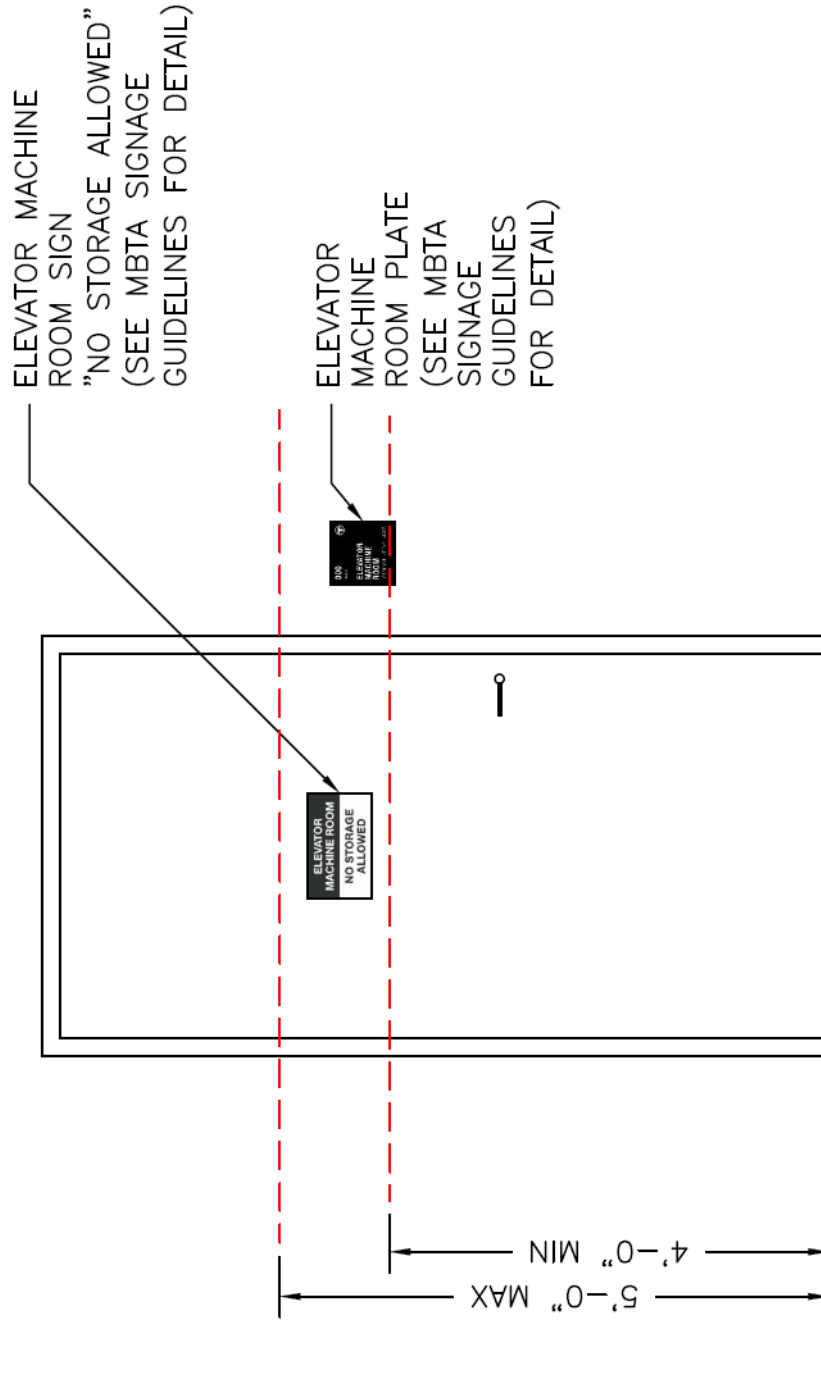

Elevator Machine Room Sign (For All Elevators)



Elevator Machine Room Sign

Note: Mount to latch side of elevator machine room doors. Consultant to provide: room name and numbers. MBTA Graphics and Wayfinding to provide the sign graphics files for construction drawings and production.

Elevator Machine Room Door Sign

Option One (for Machine Room Less Traction Type Elevators)



Option Two (for All Other Type Elevators)



Elevator Machine Room Door Sign

Note: Mount to elevator machine/controller room door. Two options depending on type of elevator. A machine room less traction elevator shall have the MRL Elevator Control Room mounted onto the Controller Room. All other elevators will have the Elevator Machine Room No Storage Allowed sign mounted to the machine room. MBTA Graphics and Wayfinding to provide sign graphics files.

Emergency Call Box and Associated Illuminated Sign (For All Elevators)

Emergency Call Box Associated Illuminated Wall Mounted Sign

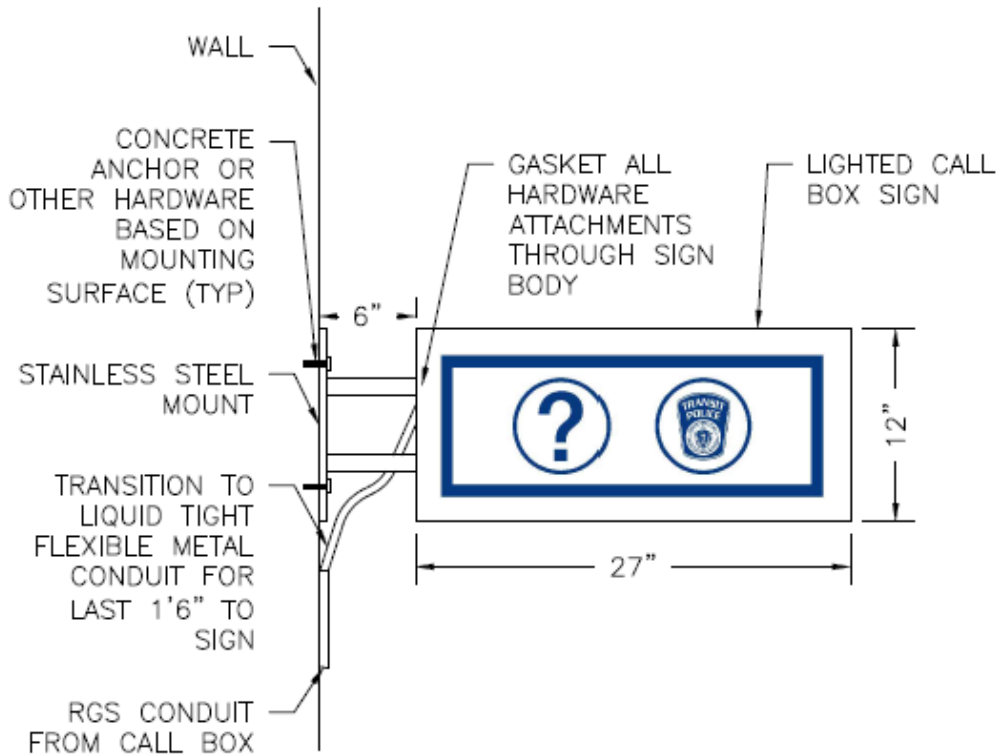

Emergency Call Box Associated Illuminated Ceiling Mounted Sign

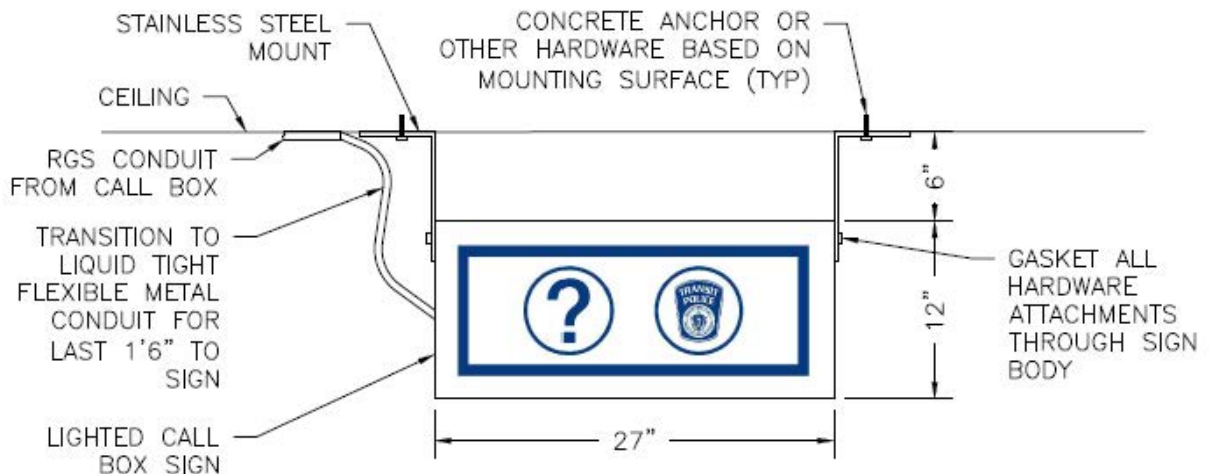

Please note: The illuminated sign for the Emergency Call Box shall be mounted at a minimum of 80" H.

Emergency Call Box

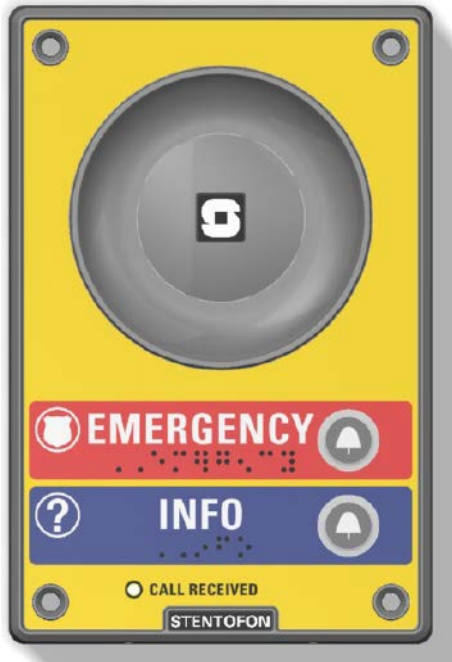

Each elevator opening shall have an Emergency Call Box and Associated Illuminated Sign. Always confirm current Emergency Call Box unit with MBTA Security. Zenitel is the manufacturer of the MBTA Emergency Call Box (www.zenitel.com info@zenitel.com). Part number is 100016102500 or CQ161025-MBTA-00 Manufacturer description: TCIS-MBTA IP station with Adapter plate and Alphacom License. The dimensions of the Emergency Call Box are 7.1”H x 4.7”W x 2.8”D.

Please note: The highest operable button of the Emergency Call Box shall be at 48”H from finished floor. If the depth of the emergency call box protrudes from the wall farther than 4” then the void underneath the unit will be encased in stainless steel (brushed no. 4) to the finished floor.

Emergency Call Box Associated Illuminated Sign Graphic



Please note: Emergency Call Box Associated Illuminated Sign Graphic shall be (dimension from the outer blue border) 23.75” W x 8.75” H. MBTA Graphics and Wayfinding to provide sign graphics files.

Additional Elevator Related Signs

Elevator Machine Room Less Type Traction Elevator Sign

Please note: An additional sign is required per MA 524 CMR for machine room less type traction elevators showing where the control room is located. *“A permanent sign shall be mounted on the head jamb of the main floor entrance, which shall read “MRL-CONTROL ROOM LOCATED ON ___ FLOOR”. It shall be a minimum of ¾” high and shall be a contrasting color with that of the background.”*

9th edition Advisory Note Appendix H – Elevators Related Signage Design Requirements

The latest edition of the MBTA Wayfinding Signage Guidelines shall be followed. Designer Role and Process for Signage is as follows:

The MBTA is responsible for:

1. Layout of signage based on pathway diagrams.
2. Design of sign graphics using custom software.
3. Creation of full scale sign used for fabrication.

The MBTA provides all sign plans, sign schedules and sign elevations.

The Design Consultant is responsible for:

1. Evaluation of existing sign frames (at existing stations).
2. Selection and engineering of sign frames and details
3. Coordination and integration of signage with station architecture under direction of MBTA.

The Design Consultant is also responsible for incorporating all signage content into the construction documents.