



Contract No. K78PS01

## Station Platforms and Canopies

*Material and Form Analysis and Recommendations*

*Prepared for:*

*Massachusetts Bay Transportation Authority  
100 Summer Street  
Boston, Massachusetts*

*Prepared by:*

*The VHB/HNTB Team – a Joint Venture  
in association with Fennick McCredie Architecture  
99 High Street, 10<sup>th</sup> Floor  
Boston, Massachusetts*

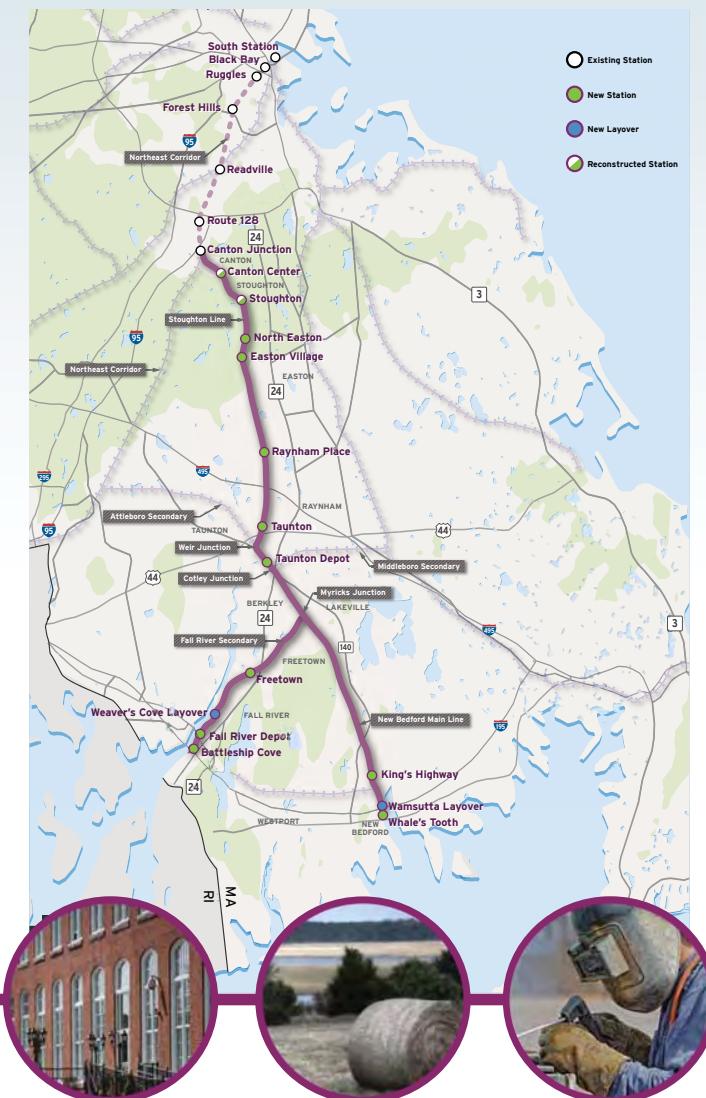

December 30, 2016

*This page intentionally left blank.*



## TABLE OF CONTENTS

<b>1.0 Introduction</b>	
Project Overview	1.1
Purpose of this Report	1.2
Methodology	1.3
Summary of Recommendations	1.4
Next Steps	1.5
<b>2.0 Precedent Research</b>	
Existing MBTA - Stations	2.1
Existing MBTA - Platforms	2.2
Other Transit Systems - Steel Canopies	2.3
Other Transit Systems - Concrete Canopies	2.4
Non-Transit Projects	2.5
<b>3.0 Materials Analysis</b>	
Platform Slabs	3.1
Tactile Warning Strip	3.2
Heated Platforms	3.3
Canopy Framing	3.4
Coating Technologies for Steel Canopies	3.5
Canopy Roof Materials	3.6
<b>4.0 Form and Type Studies</b>	
Platform Foundations	4.1
Platform Framing	4.2
Canopies	4.3
<b>5.0 Recommendations</b>	
Material Matrix	5.1
Material Recommendations	5.2
Cost Considerations	5.3
Form Recommendations	5.4
Code Compliance Review	5.5
<b>6.0 Appendix - Cost Estimate</b>	

## 1.0 Introduction

### 1.1 Project Overview

The SCR project is an initiative of the Massachusetts Department of Transportation (MassDOT), implemented through the Massachusetts Bay Transportation Authority (MBTA). The purpose of the project is “to more fully meet the existing and future demand for public transportation between Fall River/New Bedford and Boston, Massachusetts, and to enhance regional mobility while supporting smart growth planning and development strategies in the affected communities.” The SCR project will extend the existing Stoughton Line commuter rail service south to Fall River and New Bedford.

The project will provide electric commuter rail service, with stops at the reconstructed Canton Center Station and the relocated Stoughton Station as well as ten new stations (North Easton, Easton Village, Raynham Place, Taunton, Taunton Depot, Freetown, Fall River Depot, Battleship Cove, Kings Highway, and Whale’s Tooth). Two new overnight layover facilities will be constructed (Weaver’s Cove in Fall River and Wamsutta in New Bedford). The project will use 15.5 miles of the existing Northeast Corridor infrastructure between Boston and Canton Junction; improve 3.8 miles of existing track from Canton Junction to Stoughton; restore track infrastructure on the 16.4-mile Stoughton Line between Stoughton and Taunton; reconstruct 20 miles of the New Bedford Line from Taunton to New Bedford; and reconstruct 12.3 miles of the Fall River Line between Berkley and Fall River. A second track and passing sidings will be added where needed to support the future commuter and freight operations. The project will also reconstruct or replace railroad bridges over roads and waterways, and will need to reconstruct three highway bridges that cross over the railroad. Grade crossings will be restored along the inactive segment. Upgrades to equipment and signals at all at-grade crossings will meet modern standards.

Following the completion of the MEPA process, the MBTA retained the partnership of VHB and HNTB as its Program Manager-Construction Manager (PM CM) for the project. The project is currently in the preliminary design and permitting phase.

### 1.2 Purpose of this Report

The *Urban Design and Universal Access* report completed earlier in this preliminary design and permitting phase focused on arrival modes to the station; connectivity to the broader community; universal accessibility; and code compliance issues in developing station concept plans, but did not address specific form and materials of the stations. The primary purpose of this report, therefore, is to present station platform and canopy form and material recommendations at SCR stations. Material precedent research and analysis, and form and types studies for platform and canopy elements are included to support the development of the recommendations. This report is viewed as a first step toward the 30% preliminary design submission.

It is important to note that this report focuses on platform and canopy elements only. A separate report regarding recommendations for vertical transportation systems (ramps, stairs, pedestrian bridges, and elevators) at center island station will be produced in the next year of the project.

### 1.3 Methodology

A four-step process was used to develop the form and recommendations presented in this report.

**1. Precedent Research** - The PM CM team reviewed existing MBTA stations noting positive and negative characteristics of each station as measured against the *Design Criteria* and feedback from the MBTA. The team then looked at stations in other transit systems and non-transit canopies as a means of generating possible new form and material approaches for SCR station design. The findings are presented in Section Two of this report.

**2. Materials Analysis** - A list of possible materials was developed from Step One and researched for appropriateness with respect to the *Design Criteria*. Through meetings with product vendors and a series of workshops with the MBTA, the PM CM was able to narrow the focus to a few materials for further research and development. The materials are presented in detail in Section Three of this report.

**3. Form and Type Studies** - Using the information gathered in Steps One and Two, several platform types and canopy forms were explored and measured against the performance criteria set out on the *Design Criteria*. The preliminary roof and platform types were then discussed with the MBTA, again via several workshop style meetings. The most promising of the canopy forms - flat and double-winged roofs - are discussed in Section Four of this report, with recommendations presented in Section Five.

**4. Material Matrix and Recommendations** - The material matrix (figures 1 and 2 in Section Five of this report) was developed through an ongoing dialogue between the PM CM team and the MBTA as a way to easily visualize the material presented in Section Three of this report. This information is used as a basis of form and material recommendations presented in this section of the report.

## 1.4 Summary of Recommendations

Canopies and platforms were refined and judged against their potential to meet the goals set out in the *Design Criteria* (accessible, sustainable, durable, economical, and enhancing user safety and experience), the *Urban Design and Universal Access* report, and Sections Two and Three of this report. Continuing the workshop-style meetings with the MBTA and conversations with product vendors, the PM CM team arrived at the recommended approach to canopy roof forms presented in Section Five of this report and summarized below.

**Platforms:** The recommended high platform structure for side platforms shall consist of the Fiber Reinforced Polymers (FRP) supported by steel beams on the back side and a retaining wall on the front side. The retaining wall will allow for varied grade elevations adjacent to the wall. The steel beam shall be supported on piers on spread footings. Where micropiles are recommended, steel beams and retaining wall shall be supported on a pile cap, which in turn is supported on micropiles.

The recommended high platform structure for center island platforms shall consist of FRP supported by steel beams on each end. (NOTE: Due to ongoing code issues with the State Building Inspector's Office, the likelihood of approval of FRP is limited for center island platforms. Based on this, the alternative recommended platform material for center island platforms is Ultra High Performance Concrete - UHPC.) Steel beams shall be supported on piers on spread footings or on pile caps, which in turn are supported on micropiles. This type of foundation has less impact on existing tracks during installation than the conventional spread footings.

**Canopies:** Canopy frame materials are recommended to be either steel with a 3-part fluoropolymer type finish system ('TNEMEC' used as the basis of design for this report) or steel with metalizing. Canopy roof materials are recommended to be either zinc roofing over structural metal deck or Structural Composite Sandwich Panels ('Kalwall Open Canopy'-type system was used as a basis of design for this report). Structural translucent panels passing UL790 and having a Class A classification meet the letter of the code, but the Authority Having Jurisdiction should be consulted early in the final design process to ensure there aren't interpretations that would limit use in SCR canopy roofs. The PM CM team also believes that a single source scenario with a painted/ anodized aluminum structure and structural translucent panel roof offers compelling benefits for the SCR project.

A single-wing canopy is recommended along side platform stations to the side of the Transition Plaza (see Section A, page 39). This form is economical, provides good coverage for passengers, and allows the roof to drain directly into landscaped areas adjacent to the platform without the use of gutters. However, the drip edge and strategic screening of the platform will need to be detailed in such a way as to ensure no windblown rain or snow reaches the platform. Holding the columns back from the platform will provide additional weather protection and help to free up space on the platform.

A double-wing canopy is recommended at center island platform canopies and for Transition Plaza entrances at side platform stations. The double-winged roof (see Section B, page 39) both signifies entry and prevents having a dripping roof edge where passengers enter the platform at these stations. This section would require internal gutters.

A shed-type roof (see Section C, page 39) occurs at ramps located at the Transition Plaza of grade-separated side platform stations. Where site conditions permit, this section would not require a gutter, allowing the roof to drain directly into adjacent landscaped areas instead.

In all cases, the PM CM team recommends mounting the columns on concrete piers held above the platform elevation. This approach will reduce potential for damage to the columns, and minimize maintenance.

## 1.5 Next Steps

The next step in advancing schematic design of platforms and canopies will be the approval by the MBTA of the approach recommended in this report. If the PM CM is granted approval, the five stations in the Southern Triangle (Whale's Tooth, Kings Highway, Freetown, Battleship Cove and Fall River Depot) will be delivered with the Preliminary Design submittal at the conclusion of Year 2.

Concurrently, sustainable features like PV arrays in parking lots and platforms are being investigated. In terms of affordability, pricing continues to fall at the same time that efficiency is increasing, making solar an attractive option. However, attention must be paid to government incentives, which are subject to change. While the majority of canopies in this project face west, rather than the traditional south, current research shows that west-facing arrays should not be ruled out. They can be expected to produce approximately 80% of the output of a south-facing array. If tied to the utility grid, west-facing arrays may also increase profitability by producing their peak amount of electricity in the late afternoon, a higher-demand time than south-facing arrays. Little to no maintenance is required over the expected 25-year life span. Discussions have been initiated with various vendors, but have not been advanced in sufficient detail to be incorporated in this report. If seriously considered, solar should be folded into the design process as early in the next phase as possible, as it could have significant impact to station design, particularly if used in platform canopy roofs. Current siting of platforms suggests good candidates for solar canopies include Easton Village, Raynham Place, and Taunton Depot on the Stoughton Straight Line, plus Kings Highway and Whale's Tooth on the New Bedford branch.

## 2.0 PRECEDENT RESEARCH

### 2.1 Existing MBTA - Stations

Key design takeaways from existing MBTA stations:

A. Galvanized steel does not promote the durability and maintainability goals of the *Design Criteria*.

B. Traditional gable forms are undesirable because they limit passenger comfort and platform durability, shedding rainwater toward boarding passengers and the tactile strip edge, and increase maintenance (e.x. cleaning bird droppings from structural supports).

C. Connecting to multiple modes of transit is important to the success of a station.

D. Clearly defined and efficient circulation patterns enhances passenger experience.

E. Alternative structural systems and roofing material used in recent MBTA stations (ex. concrete structure at Assembly and translucent roof Ashmont) offer possible design approaches for satisfying core design criteria of durability, maintainability, and enhancing passenger experience.

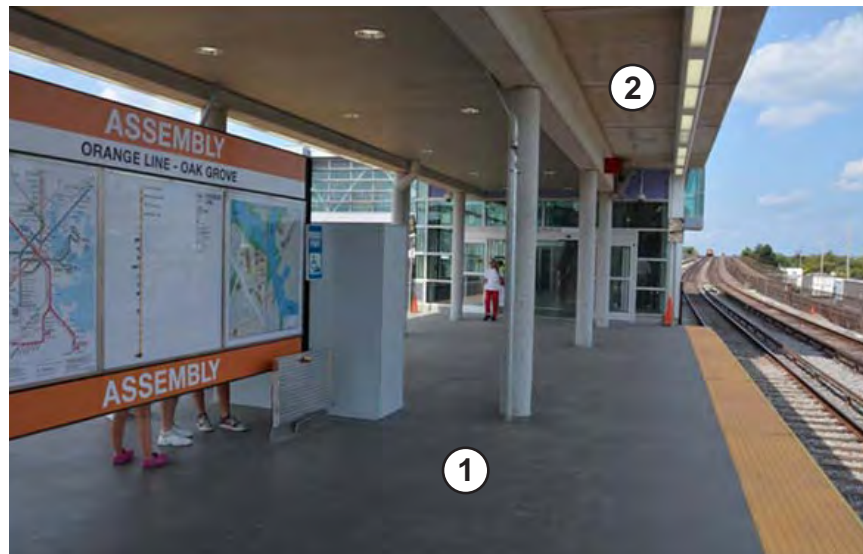

**Assembly Row T Station**  
Boston, MA

1. Methyl-methacrylate (MMA) applied over concrete holds the potential to perform well in heavy traffic areas, but is not appropriate for all locations.
2. Concrete offers an interesting alternative to typical steel canopies, but salt and freeze-thaw cycles can still impact long-term durability.
3. Platform shelters are a passenger amenity and should be considered for stations on the SCR. (Shelters not shown in this photo)



**Ashmont/Peabody Square Station**  
Boston, MA

1. The large slope at the station entrance provides only limited protection from the elements.
2. The use of a translucent roofing materials enhances passenger experience by providing natural light to brighten conditions under the canopy.

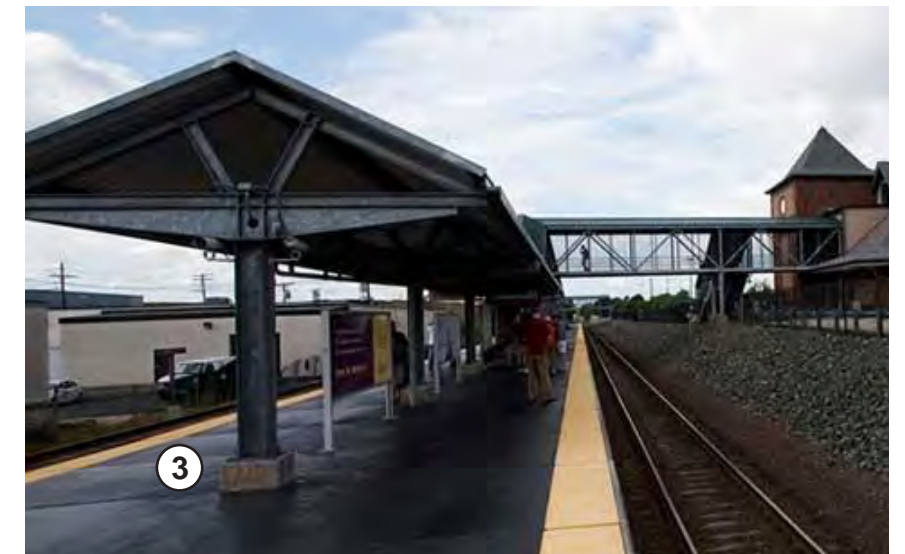

**Anderson/Woburn Station**  
Woburn, MA

1. The use of traditional gable forms is undesirable because the roof sheds water towards passengers as they enter and exist trains. These structure also create bird perches, and exposed conduit and drainage systems.
2. Locating bus service near the platform entrance would have enhanced passenger access to the station and connectivity to the community.
3. The use of a concrete base at the bottom of galvanized steel columns may reduce the corrosive impact of salts on the canopies.

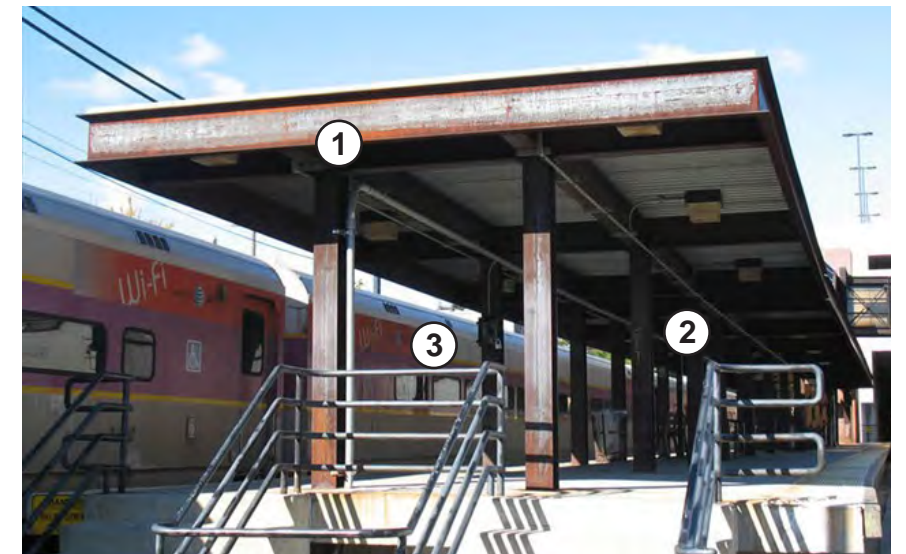
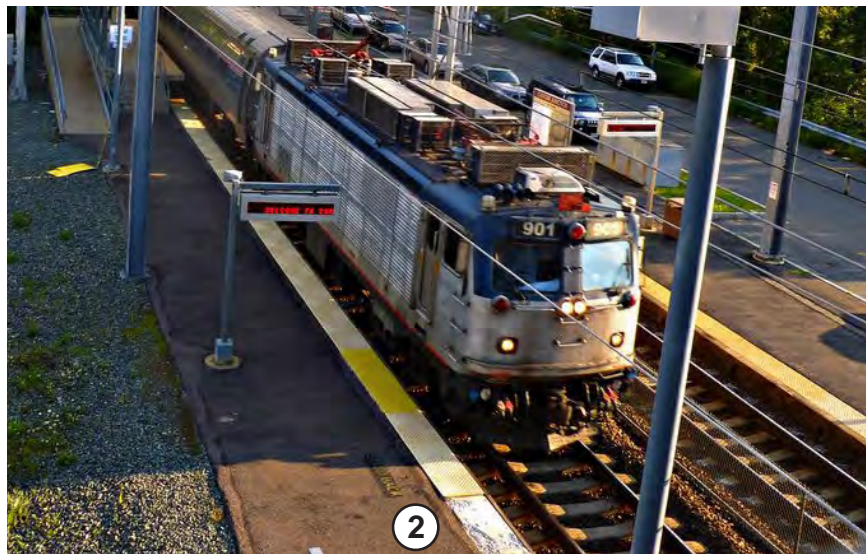

**Canton Junction**  
Canton, MA

1. The circulation pattern creates an inefficient and confusing means of circulation that degrades passenger experience and convenience.
2. Failure of detectable warning strips limits accessibility for those with mobility limitations and pose a safety hazard to all passengers.

**Littleton Station**  
Littleton, MA

1. Providing ramp only access at a center island platform negatively impacts experience and efficiency for many passengers.
2. The use of reflective material on structures that cross the tracks can cause visibility issues for the train crew. In this case, mitigation was needed to reduce reflections off of the bridge glazing.
3. The use of painted steel provides an additional layer of protection than that found on galvanized steel alone.

**Lowell Station**  
Lowell, MA

1. The use of weathering steel is undesirable because the by-product of the weathering process - "rust" - can be transferred to passengers that come into direct contact with the material. The weathering process also creates an uneven aesthetic and appearance of deterioration.
2. The wide canopy over the center island platform creates a dark waiting areas for passengers.
3. Adding a second column clutters the platform

## 2.0 PRECEDENT RESEARCH

### 2.1 Existing MBTA - Stations



**South Attleboro**  
South Attleboro, MA

1. The use of traditional gable forms is undesirable because the roof sheds water towards passengers as they enter and exist trains.
2. Galvanized steel is susceptible to degradation in highly corrosive environments as with the presence of salts in winter conditions.

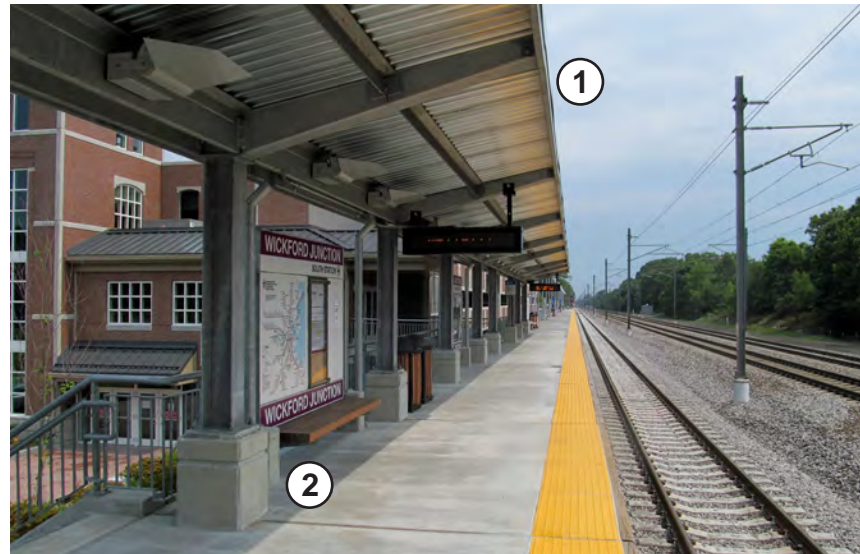

**Wickford Junction**  
North Kingstown, RI

1. The Y-shaped roof is preferable to traditional gable forms because it sheds water away from passengers entering and exiting the train. However, care should be exercised when designing one to ensure adequate cover for passengers.
2. The use of a concrete base at the bottom of galvanized steel columns may reduce the corrosive impact that winter salts have on the columns.



**Yawkey Station**  
Boston, MA

1. The concrete elevator shaft does not lend itself to an open and visually connected elevator, raising concerns about safety and security.



## 2.2 Existing MBTA - Platforms

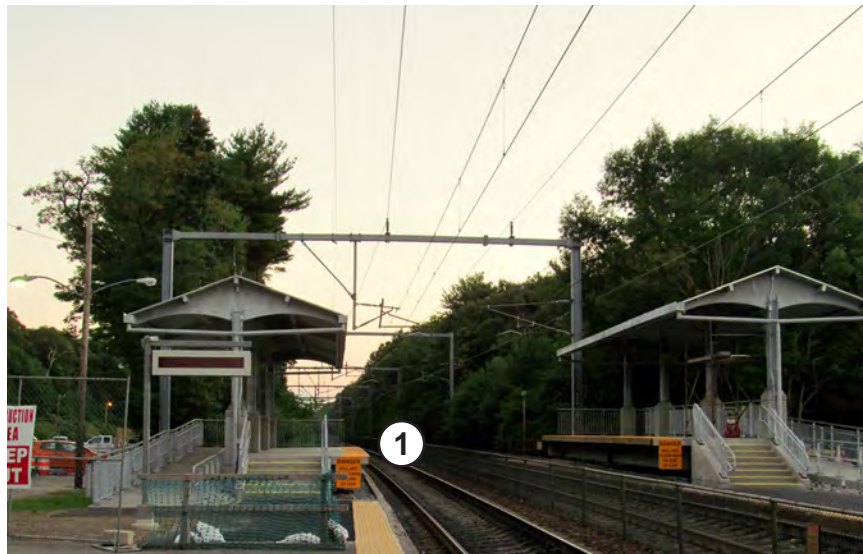

**Sharon Station**  
Sharon, MA



**South Attleboro Station**  
South Attleboro, MA

1. Mini-high platforms currently exist in the commuter rail system, but don't provide a universally accessible station or system.

2. At-grade platforms currently exist in the commuter rail system, but they do not meet accessibility standards, and the use of asphalt increases maintenance demands.



**North Scituate Station**  
Scituate, MA

1. High level platforms allow for a fully accessible station, and helps to promote a more accessible system.

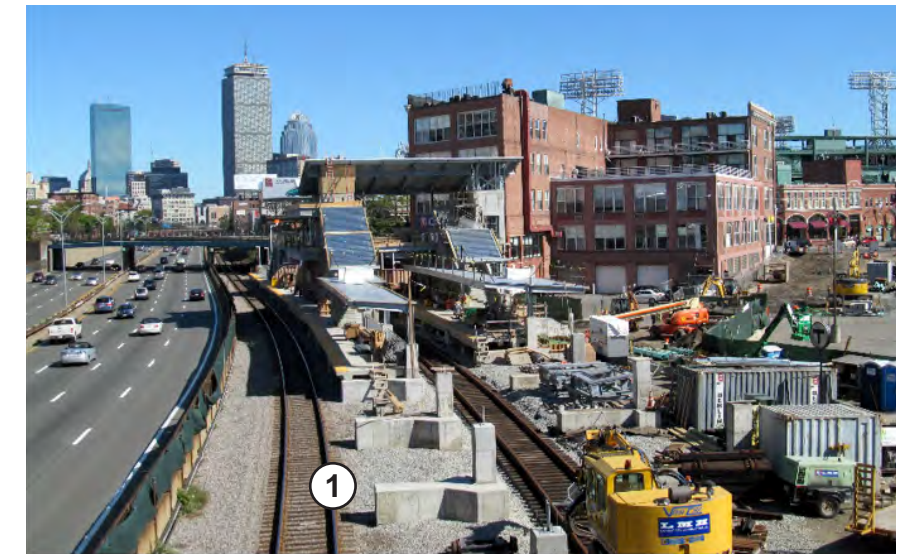

**Yawkey Station**  
Boston, MA



**Savin Hill Station**  
Boston, MA

1. Founded on pile caps supported by PIFs (pressure injected footings).

2. Supported by concrete beams founded on drilled shafts

## 2.0 PRECEDENT RESEARCH

### 2.3 Other Transit Systems - Steel Canopies

Key design observations from other transit systems:

A. Innovative use of materials for canopies (ex. polycarbonate) and stair enclosures (ex. stainless steel mesh) reduces structural requirements, limits reliance on artificial light, and enhances passenger experience. Moreover, these materials suggest a forward-looking aesthetic appropriate for a 21st Century transit system.

B. Concrete - particularly Ultra-high Performance Fiber-reinforced Concrete (UHPFRC) - is an extremely durable material that is economical over its life-cycle and has great aesthetic flexibility, all important factors in the Design Criteria.

C. Use of glass increases transparency, promotes a sense of security in stations, and visually connects passengers to surrounding areas. However, cost and issues of replacing damaged glass are challenges.

D. In addition to functionality, lighting can be seen as an important design tool. (ex. Aberdeen, Everett, Mt. Baker, Shawnessy, and Lamprechtshausen Stations)

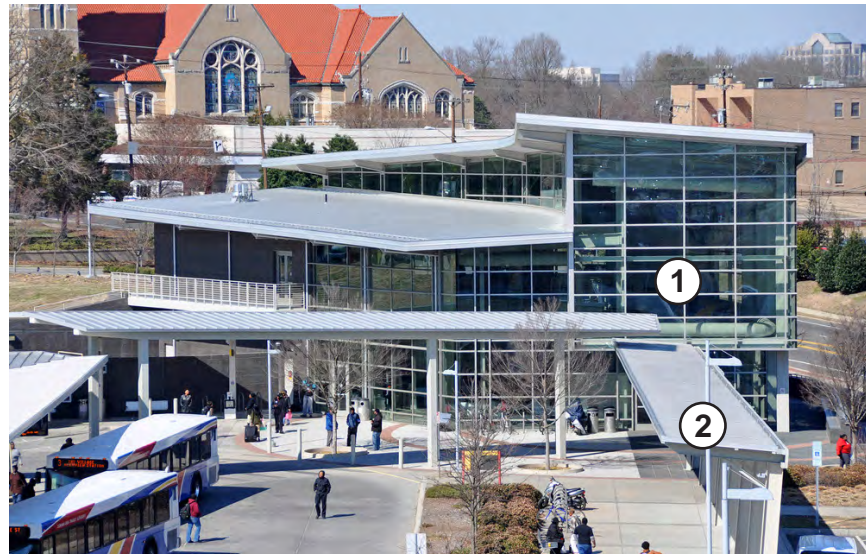

**Durham Station Transportation Center**  
Durham, NC

1. The use of glass affords passengers enhanced visibility and heightens a sense of safety and security, while capturing desirable views around the station and providing protection from the elements.

2. The form of the canopies are meant to acknowledge the area's historic industrial character. However, the canopies are very tall and don't seem to offer great protection from elements. (Heights of canopies should be kept to as close to the allowed minimum as possible.)



**Chicago Transit Authority - Morgan Street Station**  
Chicago, IL

1. The use of glass on the bridge and stainless steel mesh on the stairs were chosen to reinforce the openness of the station while also providing weather protection.

2. The use of translucent panels in the canopies provides weather protection, permits natural light, and reduces the amount of structure needed because of the low weight of the material.

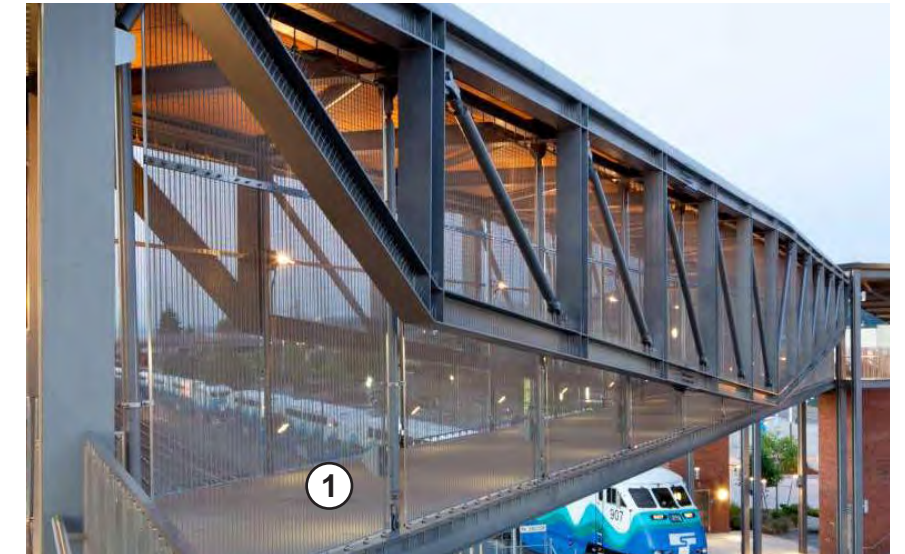

**Everett Station**  
Everett, WA

1. The transfer bridge over the track is enclosed with architectural mesh and hung off of a truss system, which provides a strong visual aesthetic, natural light, fall protection, safety and security, and ventilation.

2. Passenger experience in the transfer bridge is enhanced by creative use of up-lighting on the ceiling from the structure.

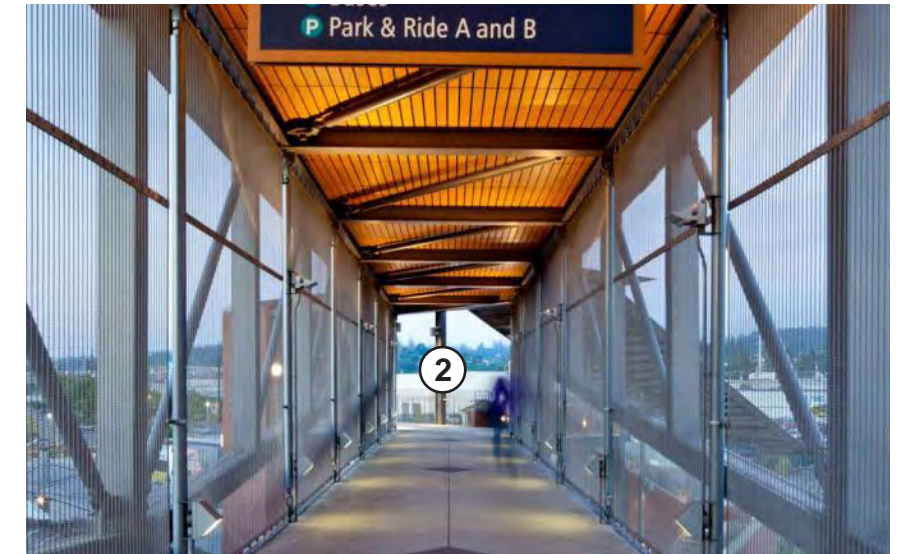



**King Street Station**  
Seattle, WA



**Mt. Baker Station**  
Seattle, WA



**South Parkway Station**  
Liverpool, UK

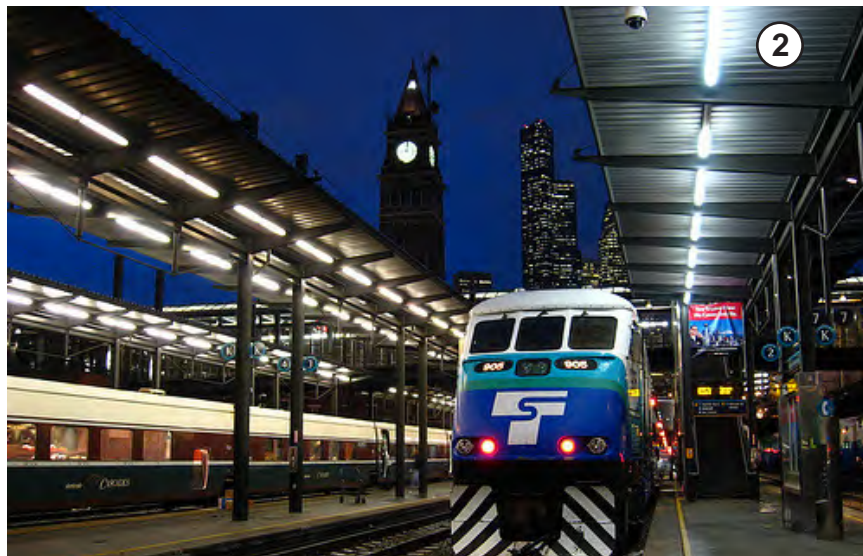

**Kent Commuter Rail**  
Kent, WA



**Mt. Baker Station**  
Seattle, WA



**South Parkway Station**  
Liverpool, UK

1. The use of glass on the stairs supports safety and security through enhanced visibility, and enriches passenger experience by creating an open station that allows visual connections to the surrounding area while protecting them from the elements.

2. The thin sections of the steel structural system and height of the canopy create a platform that is open with minimal visual obstructions. The height of the canopies may limit weather protection.

1. The light beacon atop the elevator provides a strong visual connection to the surrounding context.

2. The architectural intent of this station was to adopt the character of the surrounding neighborhood, using brick, concrete, and steel to promote natural light and a timeless quality without mimicking historic structures.

1. The use of translucent wall panels provides opportunity to incorporate natural light into the station, which enhances passenger experience and reduces reliance on artificial lighting.

2. Introduction of clear panels into the system may be desirable for safety and security issues.

## 2.0 PRECEDENT RESEARCH

### 2.4 Other Transit Systems - Concrete Canopies



**Shawnessy Light Rail**  
Calgary, AB

1. Ultra-High Performance Fiber-Reinforced Concrete (UHPFRC) was selected as the structural system for this station. The thin-shelled precast canopies (just 3/4" thick) provide an attractive, light-filled shelter for passengers. This system uses fiber reinforcing, not steel.

2. Originally designed as a steel canopy, the use of precast was chosen because of superior finishes, tight construction tolerances, speed of construction, and lower maintenance costs.



**Aberdeen Station**  
Richmond, BC

1. The palette of concrete, glass, and wood was developed as a "family" of materials to be deployed along the new Canada Line Transit System in anticipation of creating vibrant and transparent stations that connect well with their surroundings; are durable; and economical to construct. While largely successful, a post-occupancy study found that at some stations better attention to weather protection at critical areas such as double height spaces would have resulted in increased durability of steel elements.



**Lamprechtshausen Station**  
Lamprechtshausen, AT

1. Cast-in-place concrete allows for large, column-free spans.

2. Skylights introduce daylight deep under the canopy.

3. Faceted concrete piers serve multiple functions, including structure, visual barrier from adjacent commercial area, and armature for climbing plants, seen beginning to grow at the base of the piers.

## 2.5 Non-transit Projects



**Steel Canopy - Urban Park**  
Santa Monica, CA



**Steel and FRP Pedestrian Bridge**  
Cambridge, MA



**Steel and Glass Canopy - Office**  
Boston, MA



**Concrete Canopy - Department Store**  
Tampa, FL



**Concrete Structure and Roof- Museum**  
Fort Worth, TX

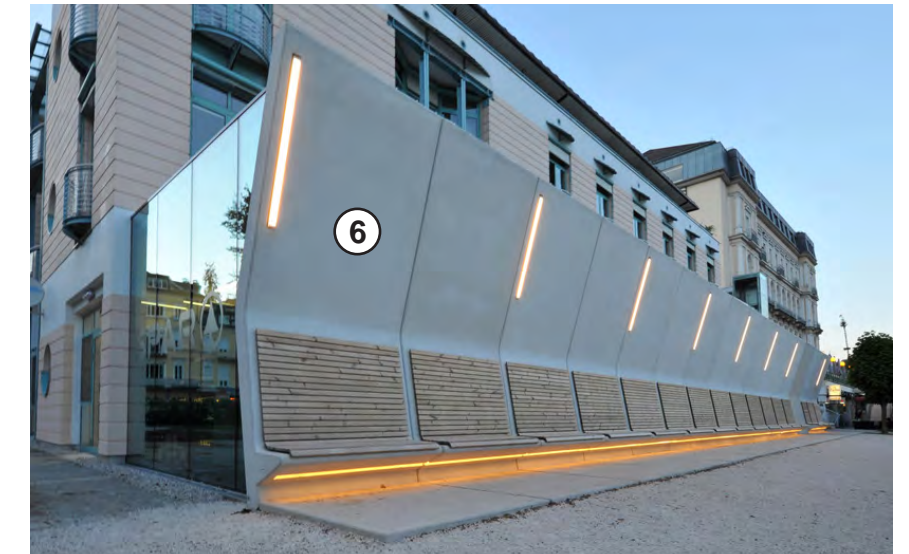

**Precast Concrete - Supermarket**  
Germunden, DE

1. Aluminum fencing material can adapt to also become shelter at benches. This adaptability might be a good approach to fencing and seating in the transition plazas.

2. Concrete canopies allow for durable structures that create dramatic spaces with minimal structural impediments on the ground.

3. The use of fiber-reinforced polymer (FRP) on the walking surface of a pedestrian bridge offers the possibility of a durable material that is adaptable to many configurations. FRP should be investigated for platforms, stairs, and ramps.

4. The use of concrete, glass, and water creates a simple and elegant structure with minimal points of contact with the ground.

5. A sleek glass and steel canopy blends into a significant historic context, offering a way to introduce modern aesthetics into sensitive historic contexts like Easton Village.

6. A precast exterior wall that also becomes seating while waiting for buses highlights possible multi functionality of design elements that can be incorporated into SCR stations.

## 3.0 MATERIAL ANALYSIS

### 3.1 Platform Slabs

#### Summary:

The PM CM team reviewed three platform slabs: precast concrete, ultra high performance concrete, and fiber reinforced polymers (FRP). Each has its benefits and limitations with respect to the *Design Criteria*. The three systems are discussed below, with recommendations presented in Section Five of this report. Options for tactile warning strips and electric slab heating are also explored below.

#### Fiber Reinforced Polymers (FRP)

Composite polymer slab panels consist of high-strength fiberglass surrounded by corrosion resistant polymers

- Lightweight, pre-fabricated decking, safe and durable
- Faster and lower cost installation
- Corrosion resistance and maintenance free
- Cross slope or crown for water runoff
- Non-slip wear surfaces for high traffic
- Integrated ADA compliant tactile warning tiles
- Internal steel connection points for railings, benches, signs, etc.
- Fire resistance for rail platforms is Class A / Class 1 (FSI<25)
- Manufacturers include ArmorDeck and Composite Advantage
- Heated FRP platforms easier to repair than heated concrete platforms



FiberSpan



ArmorDeck

### Composite Advantage FiberSpan

- Typically specified sizes are up to 50ft X 12ft
- Custom sizes and shapes available to fit specific station and track
- Squared-edge joints filled with sealants and rubber joint fillers
- Elevated platform has been installed for Chicago Metra system
- Panels can be heated

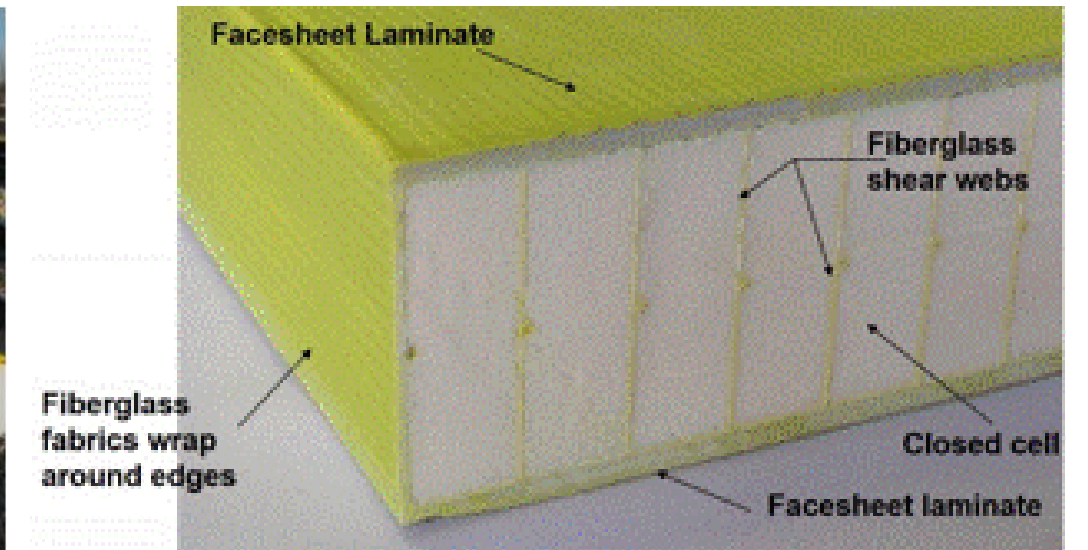

### ArmorDeck FRP

- Typically specified sizes are 36"-60" width and lengths up to 30 ft.
- The shiplap joint and leveling system provide superior alignment
- Additional features include incorporated sign and bench bases, and column covers
- In use for over 17 years and installed on roughly 100 at-grade stations in Metra system in Chicago, and over 25 elevated stations for, among others: Metra System, NJ Transit, and ConnDOT
- Proposed at Springfield, MA Amtrak station
- ArmorDeck panels can be heated, with option of heating only the tactile warning strip; system can be controlled at the site or remotely. Heated panels are currently under study at several install sites, with first full heated platform scheduled for 2016 install

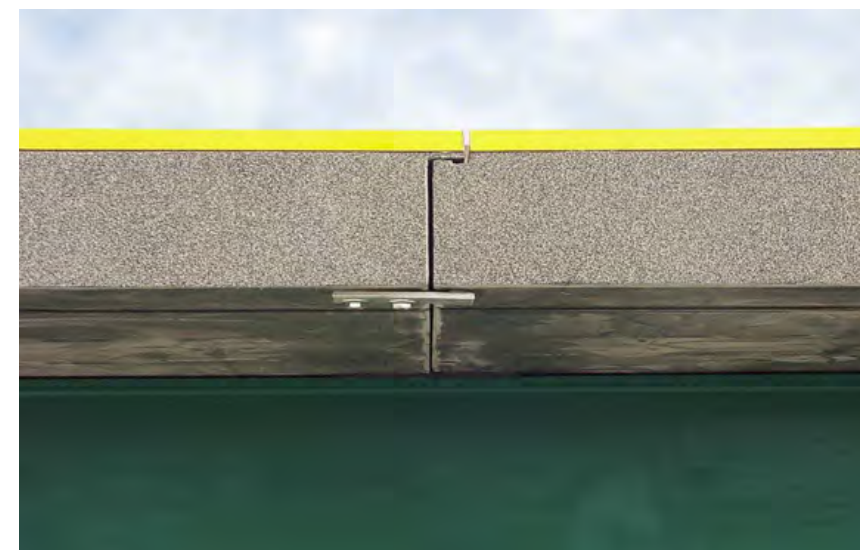

### 3.0 MATERIAL ANALYSIS

#### 3.1 Platform Slabs

##### Precast Concrete Slab

- Manufactured year-round in an indoor PCI certified facility under consistent, controlled conditions
- Inherently / typically durable and pest, weather, fire and corrosion resistant, requires little maintenance
- Utilizes recycled content, with improved indoor air quality, recyclable materials, etc.
- Can be fabricated in any shape and size with custom designs and variety of finishes
- Material can spall over time (mix can help)
- Double tees are a form of precast elements with a slab integral with the longitudinal support beams



##### Ultra High Performance Concrete Slab (UHPC Slab)

- Can be manufactured at a precast concrete plant
- UHPC has high strength and durability
- Because of a low water-to-cementitious-material ratio and low permeability, UHPC has high resistance to cycles of freezing and thawing, and very tight cracks under load
- Mixing of UHPC requires more time than with conventional mixtures
- UHPC is self-consolidating with a limited amount of external vibration
- UHPC is weather, fire, and corrosion resistant, and requires minimal or no maintenance

Initial Cost: UHPC Slab could be double the cost of HPC, but the cost may be justified because of the extended service life with minimal or no maintenance





### 3.2 Tactile Warning Strip

#### Surface Applied

Armor-Tile Tactile Systems Surface Applied Tiles are a range of products that can be applied to any transit application. They are cost effective for both retrofitting and new construction. The tiles come as a complete system, including: tile, adhesive, fasteners, and sealant. Armor-Tiles Systems Applied Tiles will meet the needs of any transit application. ([www.armor-tile.com](http://www.armor-tile.com))

- Cost effective for retrofitting or new construction
- Meets ADA standards
- Light weight and easy to handle
- Easily cut to conform to angles or radii
- Seven (7) standard sizes available
- Nine (9) colors available with Federal Color ID

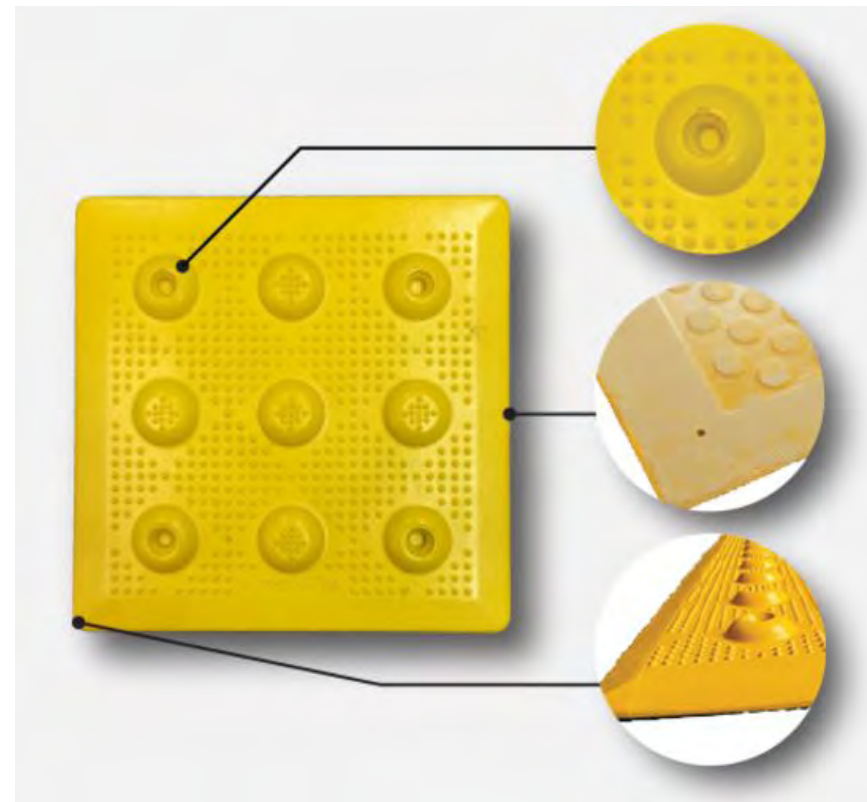

#### Cast-in-Place

Armor-Tile Systems Cast-in-Place Tiles are not only cost-effective but are a highly durable system for setting warning tiles directly into newly poured concrete, especially for transit systems. These transit systems ensure a flush installation by using embedment flanges that allow concrete to flow and lock the tile in place ([www.armor-tile.com](http://www.armor-tile.com))

- Lowest cost installation
- Meets ADA standards
- Integral embedment flanges for a complete anchoring system
- Easily cut to conform to angles or radii
- Seven (7) standard sizes available
- Nine (9) colors available with Federal Color ID

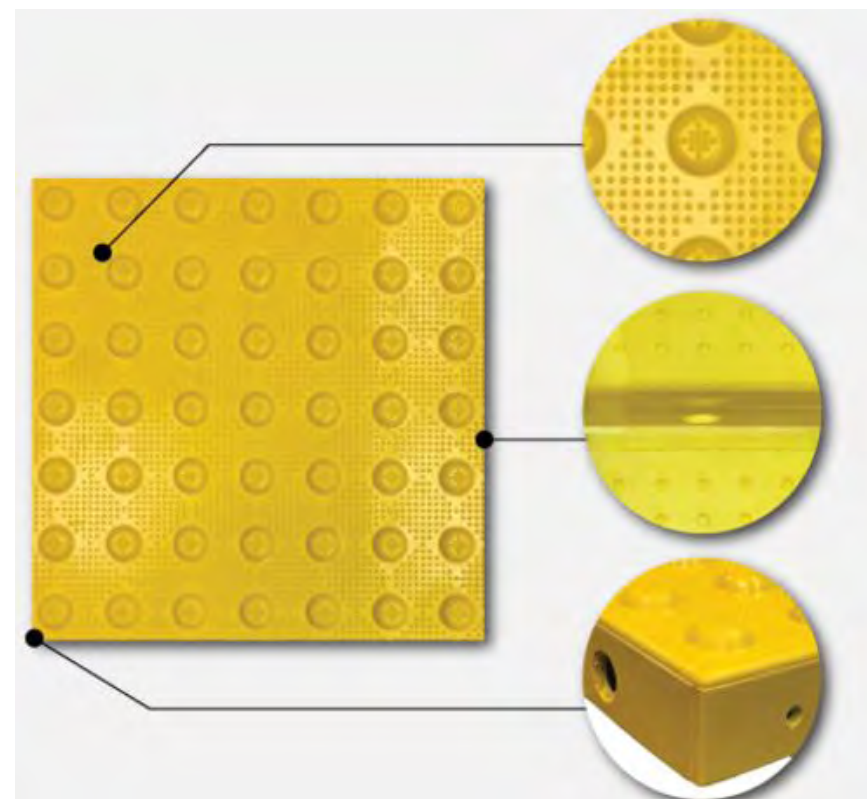

## 3.0 MATERIAL ANALYSIS

### 3.3 Heated Platforms



#### Electric

- Heating layer included under the wear surface melts ice and snow
- Great adherence in FRP (But can be used with other materials)
- Foam filled deck insulates underside; heat radiates up to surface
- Thin layer of carbon fiber that heats under electric current
- Highly redundant (not susceptible to failure like single path wire or tubes)
- One heating zone per 30'X11' panel, sensor used to input electricity
- Junction boxes molded into edges protects leads, conduit under deck
- Temperature increases of 30F in less than one hour using 400W per sq. meter; can be adjusted
- FRP Heated Deck has been provided for South Reserve Crossing pedestrian bridge project in Missoula, MT (shown above)
- Additional Cost: approximately \$15/sf

### 3.4 Canopy Framing

#### Summary:

Selecting a primary structural system is the most fundamental decision to make in developing canopy structures and should be done early in the design process since many of the subsequent design decisions flow from this primary building block.

The PM CM team reviewed five primary structural systems: steel, concrete, fiber reinforced polymer (FRP), aluminum, and heavy timber. Each has its benefits and limitations with respect to the *Design Criteria*. Each will be discussed below, with recommendations presented in Section Five of this report.

#### Steel

- Can be prone to corrosion, particularly in the heavy salt environments of the MBTA system, but durable with proper maintenance and detailing
- Coating technologies can extend life by minimizing corrosion (See Section 3.5)
- Versatile material, but shapes and fabrication may be impacted by what coating technology is used (See Section 3.5)
- Easily modified or repaired with careful construction detailing
- Recyclable/Recycled
- Contractors familiar with the material

Steel is a known quantity to the MBTA and potential contractors. And despite its proneness to corrosion, the PM CM team believes that with the proper specification of a coating technology and maintenance program, steel offers good value to meet the goals of the *Design Criteria*.



**King Street Station**  
Seattle, WA



**Rose Kennedy Greenway**  
Boston, MA

### 3.0 MATERIAL ANALYSIS

#### 3.4 Canopy Framing

##### Ultra-High Performance Concrete (UHPC)

- High initial costs
- Very durable – Low porosity
  - Limits damage in salt environments
  - Minimizes freeze/thaw cycle damage
  - Fiber reinforcing - rather than steel - can further minimize corrosion
- Versatile material
- Long spans with minimal columns and obstructions
- High quality control
- Limited track record

UHPC is an interesting material, but due to high initial costs and limited track record for canopies, the PM CM does not recommend pursuing UHPC for canopy structures. However, the potential benefits of the material are compelling enough that UHPC should be revisited if new information becomes available as the SCR project evolves.



**Chelsea Silver Line Station**  
Boston, MA



**Shawnessy Station**  
Calgary, AB

##### Fiber Reinforced Polymer (FRP)

- High initial costs
- Virtually maintenance free
- Superior corrosion resistance
- High level of quality control
- Limited aesthetic versatility
- Less familiar to contractors
- Potential code compliance issues

While FRP is an interesting material, the PM CM team does not recommend pursuing this material for canopy structures due to high initial costs, potential code compliance issues, and a likely small pool of contractors to pull from.

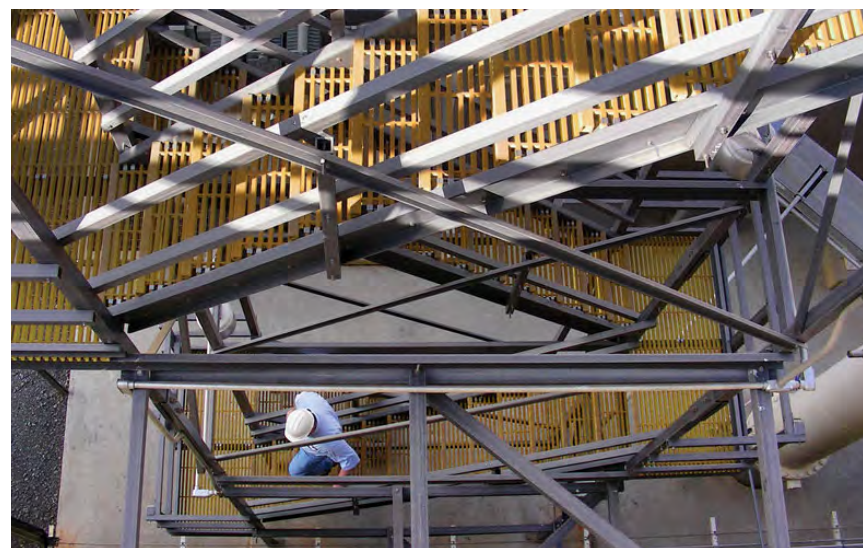

**FRP Stair at Industrial Facility**



**Pedestrian Bridge over Highway**  
New York, NY

### Aluminum with Anodizing or Powder Coat Paint

- Higher initial costs when compared to steel\*
- Durability and corrosion resistance results in good life-cycle costs
- Anodizing or powder coating extends life
- Anodizing:
  - Superior impact/abrasion resistance/bonding
  - Won't fade, peel, or flake off
  - Surface can be repaired by scrubbing off small amount of coating
  - Lifespan depends on thickness of coating
  - Matching anodized finish is difficult, and achieving a uniform finish can be tricky if surface is not adequately prepared
- Powder Coat:
  - Will outlast anodizing in corrosive environment
  - Versatile aesthetic qualities, with many color/finish options
  - UV exposure will eventually cause failure of all organic coatings, but two-part coating systems offer prolonged protection
- Recyclable/Recycled

\*Single-source Delivery is an option available for aluminum when paired with translucent, structural composite sandwich roof panels such as Kalwall (pictured). It speeds construction, consolidates responsibilities, and delivers a product that is cost competitively with steel. While aluminum would be a new canopy material for the MBTA, the PM CM team believes that with proper specification of a coating technology, aluminum offers compelling value to meet the goals of the *Design Criteria*. This is particularly true if delivered within a single-source method where the frame and roof are designed, fabricated, and installed by one vendor.

### Heavy Timber

- Lower initial costs
- Less durable / Higher maintenance (prone to vandalism)
- Proper maintenance and detailing can extend life
  - Flashing / Covers
  - Finishes / coatings
  - Shaping/cutting
- Versatile material that can be shaped into an endless array of shapes
- Good aesthetic qualities, user experience
- Recyclable / Renewable Resource (but should be FSC certified)

Heavy timber is a beautiful and warm material, but the PM CM team does not recommend pursuing this material for canopy structures because of potential code concerns and because it is less durable - susceptible to carving by vandals, for example - which would require higher levels of maintenance. The aesthetics expression of heavy timber may also not be the appropriate contextual response in many of the SCR station locations.



**Dunlap High School**  
Dunlap, IL



**Brooklyn Cruise Terminal**  
Brooklyn, NY



**BC Transit - Parkinson Station**  
British Columbia, CA



**Shelburne Station**  
Shelburne, VT

## 3.0 MATERIAL ANALYSIS

### 3.5 Coating Technologies for Steel Canopies

#### Summary:

Metal coatings are critical to prolonging the life of the structural canopy members. In addition to the two aluminum systems discussed in Section 3.4. The PM CM team reviewed four coating systems: galvanizing; a duplex galvanizing + paint system; a 3-part zinc primer, urethane, and fluoropolymer paint system; and metalizing, where a sacrificial coat of aluminum or zinc is thermally sprayed onto the metal. Each has its benefits and limitations with respect to the *Design Criteria*. The four systems will be discussed below, with recommendations presented in Section Five of this report.

#### Galvanizing

- Lowest initial cost for a coating technology\*
- Life-cycle costs are likely to be higher because history has shown that straight galvanizing is not durable in MBTA stations\*
- Few limitations in sizes or shapes provides design flexibility, but touching up field welds and performing repairs are difficult because available methods are either less durable or aesthetically unpleasant. (Zinc painting is the most durable field repair, but the color will never match the original galvanizing.)
- Limited aesthetic potential

\*Specifying a thicker coat of galvanizing would extend service life and improve durability, but increase costs.

Straight galvanizing does not perform over the long-term for the MBTA and should not be considered as a stand-alone coating technology. It is included in this report as baseline and point of comparison only.



**Galvanizing Bath**



**Kingston Station**  
Kingston, MA

### Duplex System: Galvanizing with epoxy/urethane

- Higher initial cost than straight galvanizing
- Good life-cycle costs because paint adds additional layer of protection to become the sacrificial coating over the galvanized subsurface
- Good durability - with anti-graffiti top coatings available in the form of Polyurethane clear coat - but will require frequent maintenance, repainting approximately every 10 years
- Aesthetic flexibility with an array of colors and finish options available
- Easily Maintained; paint is applied via brush, roller, or sprayer

A duplex system represents good value, but surface preparation is critical to long-term durability. If the steel subsurface is not properly prepared - leaving imperfections - or the paint is not applied within a specified time period - allowing for an oxidation layer to form - the paint will not bond well. A proper specification and/or adequate monitoring during fabrication would help to ensure performance.

A 'Colorgalv10' with epoxy/urethane type finish was used as a basis of analysis for the production of this report.



**Broadway Bridge**  
Boston, MA



**Thurston Avenue Bridge**  
Ithica, NY

### Zinc-rich Primer with Fluoropolymer Paint

- Higher initial cost than straight galvanizing, but cost competitive with a duplex system when considering life-cycle costs
- High durability with good bonding to steel; some manufacturers offer inherent graffiti resistance, while others offer anti-graffiti topcoat
- Some manufacturers offer a 15 yr warranty against color and loss of luster, which would result in one of the longest maintenance cycles of coating technologies explored, but would still require periodic painting
- Since this system is painted on raw steel - as opposed to dipping in a galvanized bath - structural members should be limited to those where all surfaces can be easily painted, which may rule out tubes.
- Easily Maintained; paint is applied via brush, roller, or sprayer

A 'TNEMEC' 3-part (zinc primer, urethane coating, and fluoropolymer coating) system was used as a basis of analysis for the production of this report. The PM CM believes this type of system represents good value, likely resulting in lower overall maintenance and continued aesthetic performance. Even though this type of system has a long service life, it will require repainting every 15 years or so to keep it performing optimally.



**Shop Application Process**



**Fields Corner**  
Boston, MA

### 3.0 MATERIAL ANALYSIS

#### 3.5 Coating Technologies for Steel Canopies

##### Metalizing (Thermal Spray)

- While previously much higher than painting in initial costs, current pricing shows metalizing to be cost competitive with other coatings.
- System has proven to be successful in corrosive marine and salty environments, lasting 25-40 years.
- Lifespan depends on thickness of sacrificial metal coating.
- An epoxy/urethane sealer can add color has been shown to extend the service life by 15-20 additional years.
- Repair to the metal coating would be difficult because it requires skilled technicians and special equipment. However, if the sealer topcoat is reapplied every 10-15 years, the material can last up to 50 years without needing repair.
- Bonds well to steel, but the porosity and thickness of the metalizing - both critical in long-term durability - are difficult to control and verify.
- Metalizing is applied on raw steel - as opposed to dipping in a galvanized bath - so structural members should be limited to those where all surfaces can be easily reached, again possibly precluding HSS tube shapes.
- May have a smaller pool of contractors to draw from

The specialized labor, the equipment potentially needed for maintenance, and the lack of track record in the MBTA system are concerns for metalizing. However, the competitive pricing and lifespan possible with a sealer make metalizing an attractive coating technology.



**Metallizing Process**



**Shop-Applied Metallizing**



### 3.6 Canopy Roof Materials

#### Summary:

The roof plays an important role in defining the character of the station; helps protect the structure, station systems, and passengers from the elements; and can greatly impact the structural requirements of the primary system due to large variation in weights and spanning capabilities of the various materials. In addition, some materials allow the possibility for recessed lighting and system conduit, while other would necessitate surface mounting of one or both. Finally, some materials - structural composite sandwich panels, for example - are a single material roof, while others - like zinc - would need to be installed in conjunction with structural wood or metal deck. The use of a single material versus multiple material roof has initial cost advantages and may make future repairs easier.

#### Galvanized Corrugated Metal Panel

- Galvanized corrugated metal panels have a low initial cost, but higher life-cycle costs due to a more frequent replacement cycle
- Poor durability: field cuts are vulnerable to corrosion, and material generally performs poorly in salt environments.
- Coatings may extend life.
- Constructability / Maintainability - easy and fast to install and repair
- Limited aesthetics
- Recycled / Recyclable

Galvanized corrugated metal decking does not meet the *Design Criteria*, and the MBTA has expressed a desire not to pursue this option for a roofing material. The PM CM also does not recommend pursuing this option, but it has been included in this report as a baseline and point of comparison.



### 3.0 MATERIAL ANALYSIS

#### 3.6 Canopy Roof Materials

##### Structural Composite Sandwich Panel

- Good initial and life-cycle costs
- Good durability - walkable and can be shatterproof; graffiti and vandal resistant coatings available, with some manufacturers offering an inherent vandal resistance. Fiber blooms are much less likely to occur than in previous generation technologies
- Reapplication of seal coat to prevent fiber blooms and retain vandal resistance is required with some products, but only recommended with others
- Some products are 'self cleaning' of normal dust and dirt
- Diffuse light masks larger debris accumulated until it can be removed
- Constructability / maintainability - Single material roof makes installation or repair easy and requires fewer trades to coordinate
- Enhanced aesthetics for passenger experience, but careful detailing is necessary because puncturing the monolithic panels is not advised. Options include mounting lighting and conduit raceway to canopy structure or detailing channels between panels.
- Must meet UL790 and be Class A classified

The PM CM team believes this product offers compelling benefits for the SCR project, but recommends getting an early review from code officials if used in the final design. A 'Kalwall Open Canopy'-type system was used as a basis of analysis in the production of this report.

##### Standing-Seam Zinc

- Reasonable initial costs, but good life-cycle costs
- Durable and corrosion resistant but detailing is important to achieving long-term performance and durability
- Constructability / Maintainability - Easy to install, but has to be used as a multi-layered system with a structural deck (metal or wood), so repair can be more difficult than with monolithic panels; brittle if installed in temperatures below 50F
- Good aesthetics / Design flexibility
- Zinc can be recycled

Zinc is a proven material that can last upwards of 60+ years, with positive aesthetics and design flexibility. While earlier cost studies indicated higher initial costs, current pricing shows zinc to be cost competitive with other roofing materials and thus a viable choice for roofing. However, potential repair difficulties may make the product less desirable. The MBTA has mentioned that there are several stations in its system using multiple-layer roof systems that have experienced deterioration of the interior surfaces that remained hidden from view, leading to maintenance problems.



**Airport Trax Station**  
Salt Lake City, UH



**Southmoor Station**  
Denver , CO



**Chatanooga State House**  
Chatanooga, TN

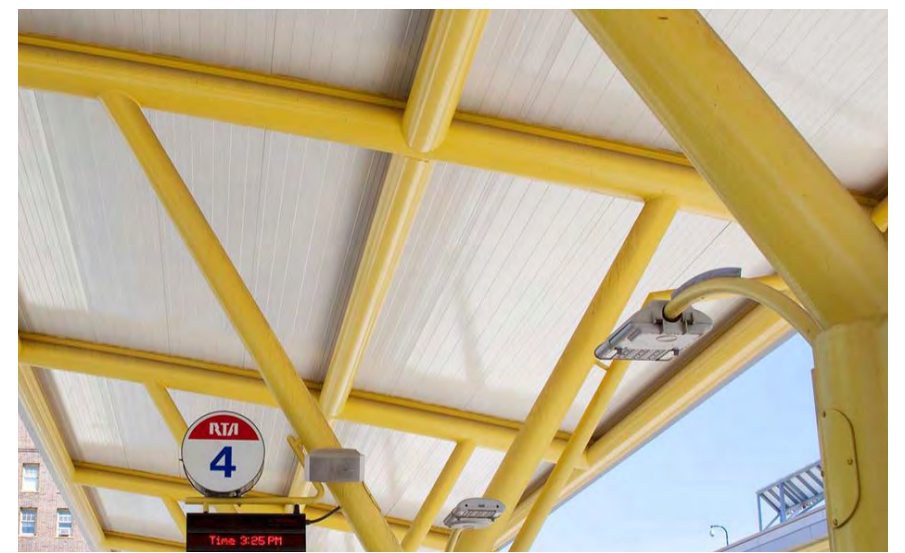

**RTA Stephanie Tubbs Jones Transit Center**  
Cleveland, OH

### Structural Metal Deck

- Reasonable initial costs, with good life-cycle costs
- Constructability / Maintainability - easy to Install, but replacement may be difficult because it needs to be installed as a system with zinc
- Good spanning capabilities
- Good aesthetics - flexible design of roof (flat, sloped, curved, scalloped); range of color options available
- Lighting can be recessed and electrical conduit raceways can be hidden if desired

With good spanning capabilities and aesthetics, the PM CM team believes structural metal deck offers good value to the project. However, like zinc and structural wood deck, this material would need to be used as a system, and may be open to similar maintenance concerns. An 'Epicore' roof deck system was used as a basis of analysis for this report.

### Structural Wood Deck

- Higher initial costs, but good life-cycle costs
- Good durability - it has been in place for more than 25 years at the Forge Park / 495 station and still in good condition
- Constructability / Maintainability - easy to Install, but replacement may be difficult because it needs to be installed as a system with zinc roofing
- Limited spanning capabilities, but can be enhanced with thicker members
- Beautiful aesthetics - flexible design of roof (flat, sloped, curved); can be clear coated or stained
- Lighting and conduit raceway can be surface mounted or recessed if sleepers are installed. The MBTA has had problems with concealed materials at other stations, however, so it is recommended that surface mounting or other exposed strategies be explored.
- Potential code compliance issues

While not a widespread material in the MBTA commuter rail system, the installations that do exist indicate structural wood performs well over the long-term. The PM CM team recommends getting an early review from code officials if used in the final design. Finally, like zinc, this material would need to be used as a system, and may be open to similar maintenance concerns.

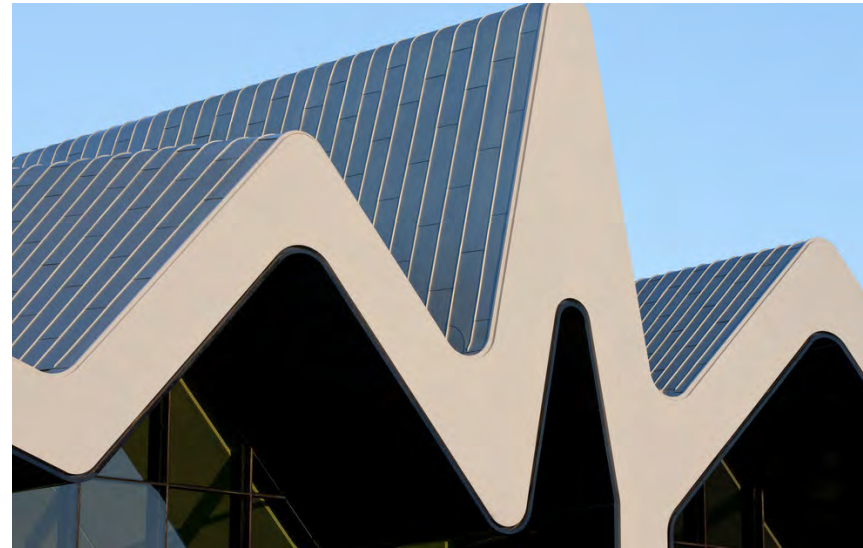

**Standing Seam Zinc - Glasgow Museum**  
Glasgow, UK

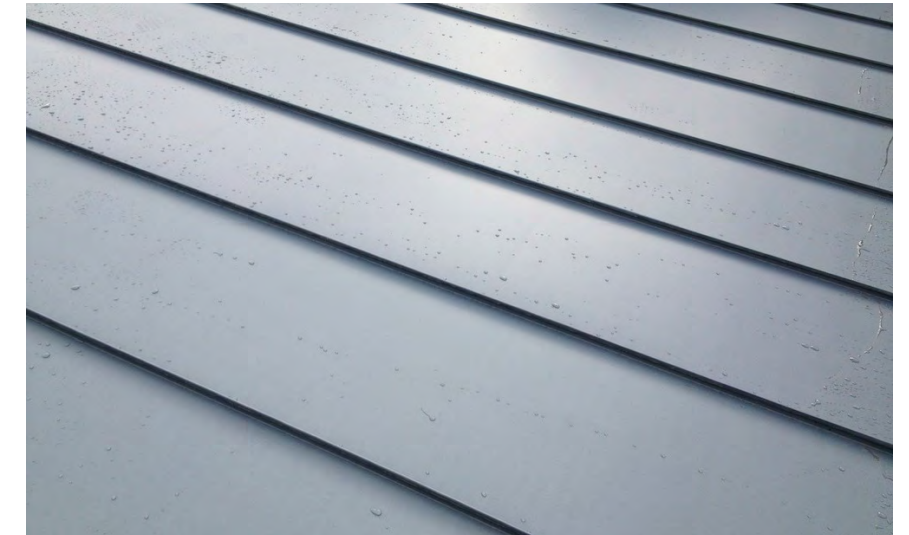

**Standing Seam Detail**



**Queensway Transit Exchange**  
Kelowna, BC



**RIT - Bus Shelter**  
Rochester, NY

## 4.0 Form and Type Studies

### 4.1 Platform Foundations

#### Summary:

The selection of a foundation for platform systems is dependent primarily on geotechnical conditions and the site and the restraints imposed by surrounding conditions.

The preliminary geotechnical recommendations for the proposed station locations indicate that spread footings would be appropriate in several proposed station locations, though some may require ground improvement techniques. Where existing soils are unsuitable for spread footings, deep foundations such as micropiles or pressure-injected footings (PIFs) offer an alternative foundation option.

Both foundation options provide advantages and may be chosen on a site-specific basis. PIFs or micropiles may be more appropriate for center island platforms where it is necessary to limit disturbance to existing tracks. Side platforms adjacent to existing or new track may be founded on either spread footings or deep foundations.

#### Shallow Foundations

- Spread footing foundations are commonly used to support platform structures
- Design based on allowable bearing capacity of competent natural soil or structural fill placed above suitable natural soil
- Bottom of footing needs to be buried a minimum of 4 ft below finished grade for frost protection
- Economical
- Existing fill conditions may require ground improvement techniques in some locations per geotechnical
- Excavation may require shoring system or dewatering
- Spread footings are the preferred foundation option at the majority of station locations provided suitable soil conditions can be achieved. In general, subsurface conditions and loading requirements should be such that spread footings offer the most economical choice



#### Deep Foundations

- Micropiles or pressure-injected footings (PIFs)
- Extend through unsuitable soils for locations where bearing capacity for spread footings cannot be achieved
- Typical micropiles used for station platform foundations are minimum 8" diameter with permanent steel casing to resist lateral bending forces
- Rely mainly on grout/ground skin friction to transfer loads to the ground and underlying competent strata
- PIFs are cast-in-place concrete shafts, typically 12-14" diameter, with an enlarged base constructed with a drop weight and steel casing that may either be removed or left in place
- Pile load tests are required for larger design loads
- Limits construction impacts on active tracks
- Deep foundations provide a solution where subsurface conditions, site constraints (such as proximity to active track at center platform locations), or the need for excavation or dewatering make shallow foundations infeasible. Depending on geotechnical recommendations and loading requirements, either micropiles or PIFs could be suitable platform foundation systems.



## 4.2 Platform Framing

### Summary:

The PM CM team investigated a number of platform framing systems for both flush transition plazas and grade-separated transitions. Among the forms considered were precast slabs supported by longitudinal steel beams on discrete piers, precast slabs supported by retaining wall structures, and precast double tees supported on concrete piers. While each platform system in this section represents a viable solution, some options integrate more fluidly with the overall station aesthetic without compromising structural or construction efficiency.

Each platform system will be discussed in the following section. A final recommendation, considered in conjunction with desired material, cost and overall design criteria will be presented and summarized in Section Five of this report.

### Steel Stringer over Concrete Piers

A slab platform supported by steel stringers on discrete concrete piers on the track side and a concrete retaining wall on the plaza side provides great versatility in that it can be easily applied to both flush transition plazas and those with a grade separation. This system is compatible for both precast concrete platform slabs as well as composite materials. The exposed segments of the plaza side retaining wall allows for a variety of aesthetic treatments.

Higher initial costs, maintenance requirements for the steel components, and mitigation of access to the underside of the platform must be considered in evaluation of this option.

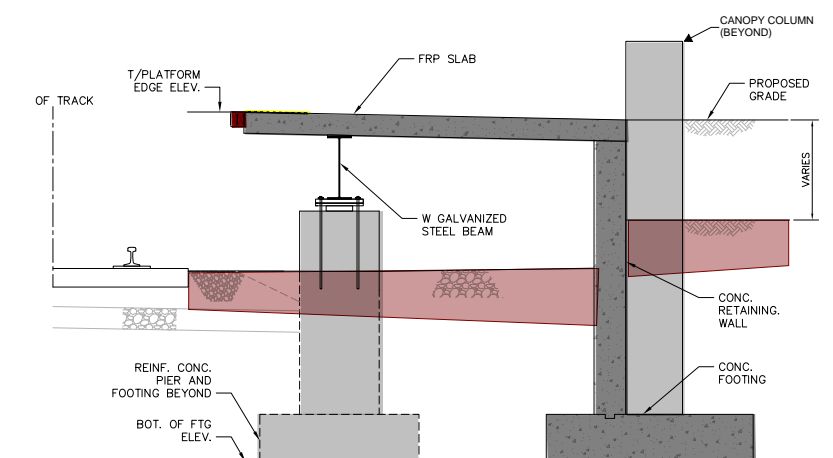

Section A - Steel Stringer

## 4.0 Form and Type Studies

### 4.2 Platform Framing

#### Concrete Retaining Wall

Platform slabs supported by a concrete retaining wall on the track side provides a low cost solution which minimizes materials required during construction. The slab can be supported on grade for flush transitions or with a second wall on the plaza side where there is a grade separation. Aesthetic treatments can be applied to exposed wall faces.

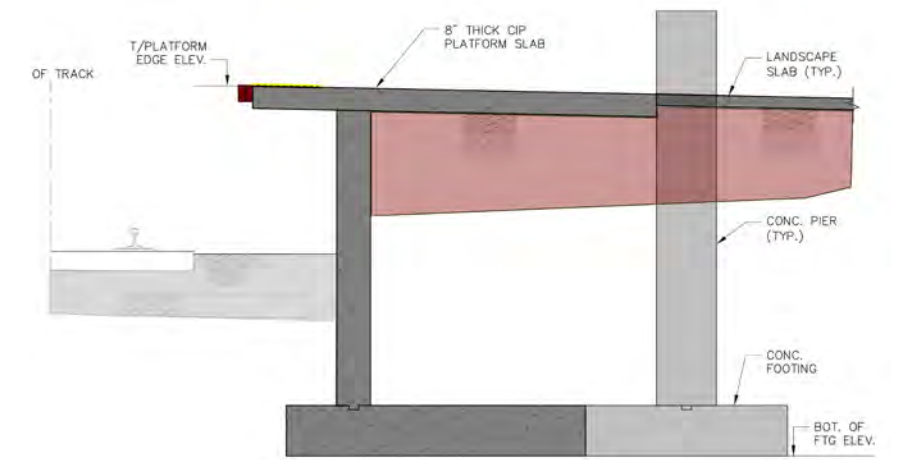

Section B - Concrete Retaining Wall

#### Precast Double Tees

Precast concrete double tee sections provide a low cost, rapid construction option for the platform system. Double tees are a common platform solution and can be used with an overlayment such as HMA (hot mix asphalt), thin-set concrete, or pavers.

The double tees do not provide aesthetic flexibility and result in a utilitarian look. A separate closure wall or asymmetric tee shape may be used (see section C) but this results in cumbersome construction and final appearance.

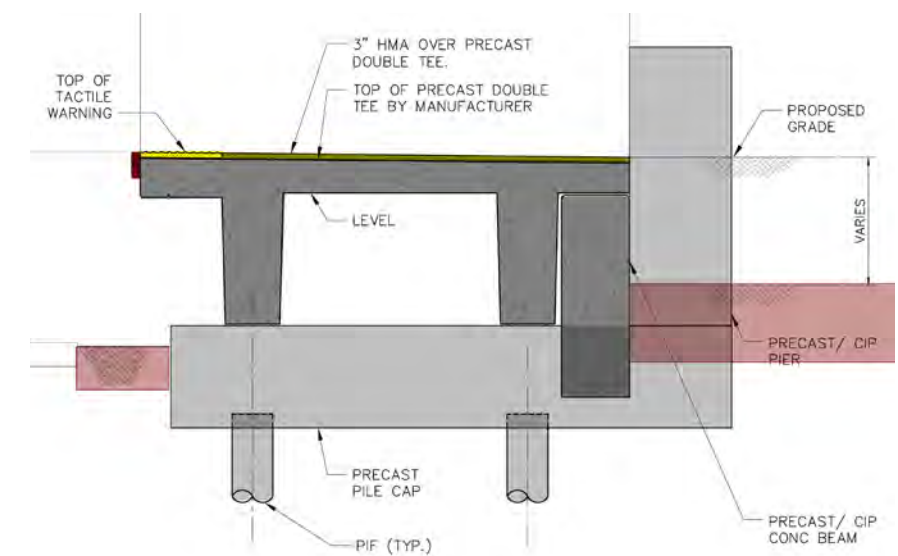

Section C - Double Tees

## 4.3 Canopies

### Summary:

The PM CM team investigated many possible canopy forms. The two presented here (flat and sloped) represent promising - and different - approaches that promote the performance objectives of the *Design Criteria*, and maximize passenger experience, while minimizing maintenance.

The biggest difference between the two is that the flat roof provides more cover for passengers - but may require more maintenance to keep the roof free from debris - while the sloped roof provides less cover from the elements, but would more easily shed debris, resulting in less roof maintenance. In any case, vertical clearance to the underside of the canopy roof should be kept to a minimum to provide maximum passenger protection while maintaining dynamic envelope clearances.

Both single and double wing configurations are recommended for use at various sections of each side platform station. These design studies are meant to convey general approaches to roof forms only. Materials and refined canopy recommendations are discussed in more detail in Section Five of this report.

### Side Platform Stations: Flush Transitions

Side platforms offer the possibility of flush transitions onto the platform where grading permits. Flush platform conditions are possible at Taunton, Kings Highway, and Battleship Cove stations. At these stations the transition plaza - a site hub of circulation and interaction - is flush with the platform, requiring no stairs or ramps to access the platform. Because no stairs or ramps (which require cover) are needed, a single wing canopy is sufficient along the platform. The single-wing form is particularly interesting for its ability to collect rainwater and direct it - with or without a gutter - to a rain garden located behind it.

In the early side platform studies shown to the right, single-wing canopies alongside the platform flank an uncovered transition plaza. Lowered sections facing the pick-up/ drop-off curb accommodate passengers waiting for transit or auto pick-up.

In later studies, the strategy of flanking an uncovered entry was modified to place a double-wing canopy at the Transition Plaza, which was shown to provide greater weather protection for passengers. This approach also provided a prominent and recognizable entrance to the platforms.

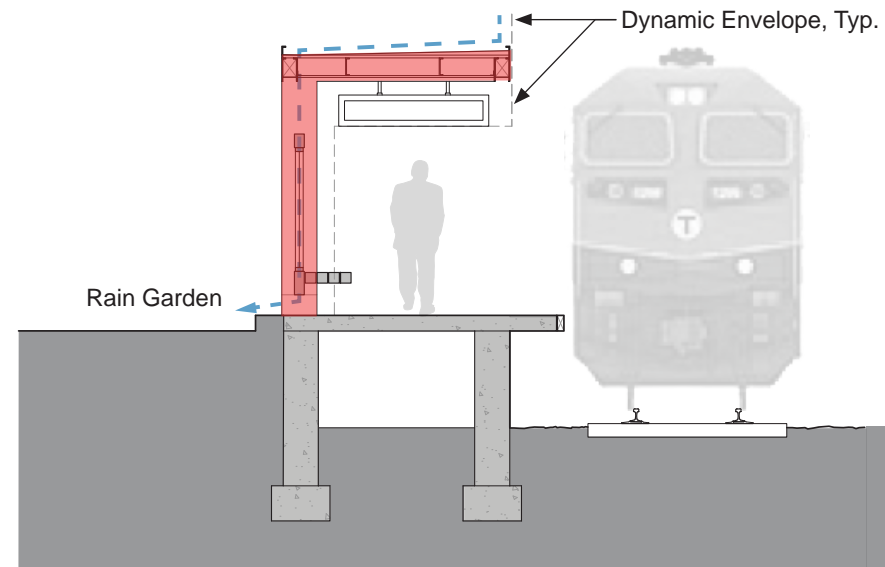

**Flat Roof Canopy Option**

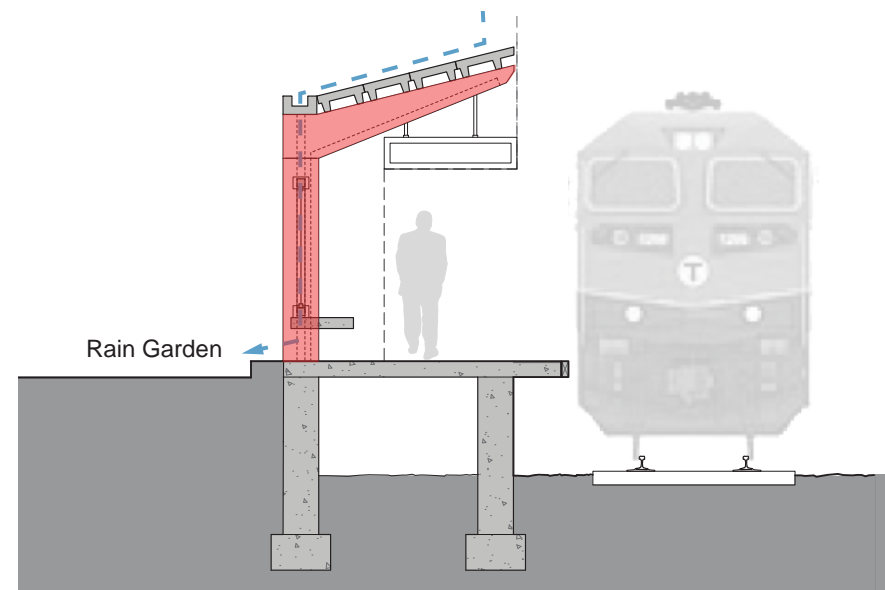

**Sloped Wing Canopy Option**

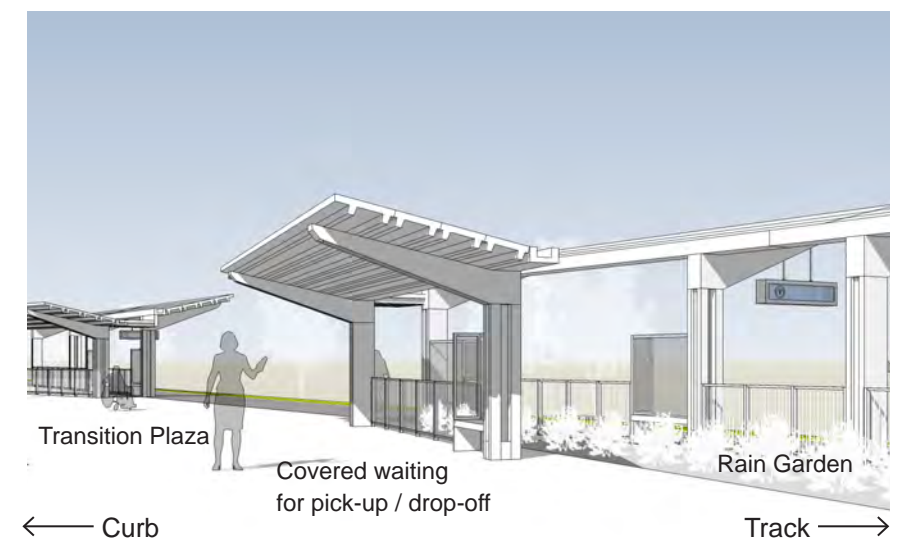
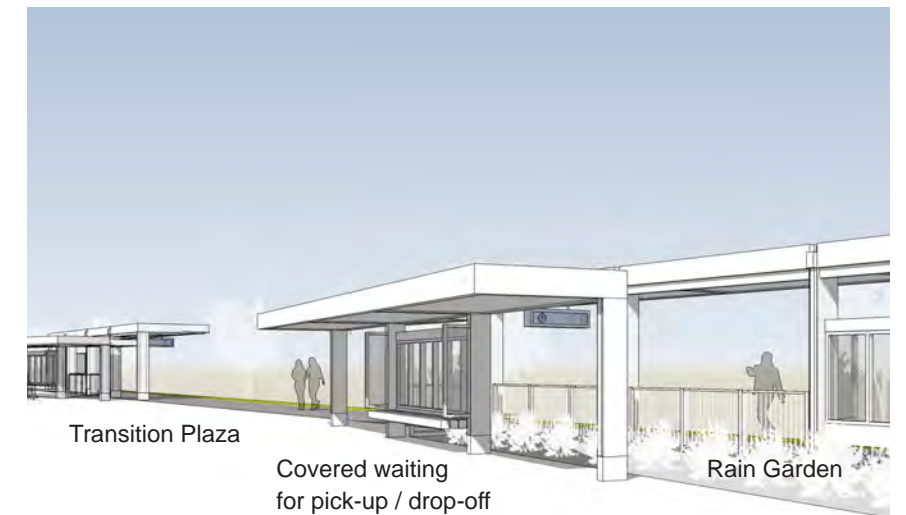

**Early Studies**  
(Transition plaza shown with no roof coverage)

## 4.0 Form and Type Studies

### 4.3 Canopies

#### Side Platform Stations: Grade-Separated Transitions

Grading conditions at Easton Village, Whale's Tooth, Freetown, and Fall River Depot stations require raised platforms. While single wing canopies still work alongside the platforms, the ramps and stairs required at these stations for accessibility necessitate greater coverage. Here, a double-wing canopy proved a promising approach to meeting the *Design Criteria*. The approach was to extend the centralized double-wing canopy at the transition plaza over the ramps and stairs, providing coverage for all passengers entering the platform.

An upturned, V-shaped roof prominently announces entry, and is easily kept clear of debris. Unlike the single-wing canopy, however, this roof form will require a gutter system to manage rainwater collected on the roof. Depending on the station, this water can be managed in an underground system or directed to landscaped areas similar to the single-wing canopy.

While initial sketches showed the promise of the V-shaped roof at the entry, there was a concern that passengers may be left too exposed to the elements while on the ramp. In later studies, a modification to the roof treatment in the form of a shed roof was introduced to minimize the exposure. (See the section to the right, and Section Five of this report for expanded development of this condition.)

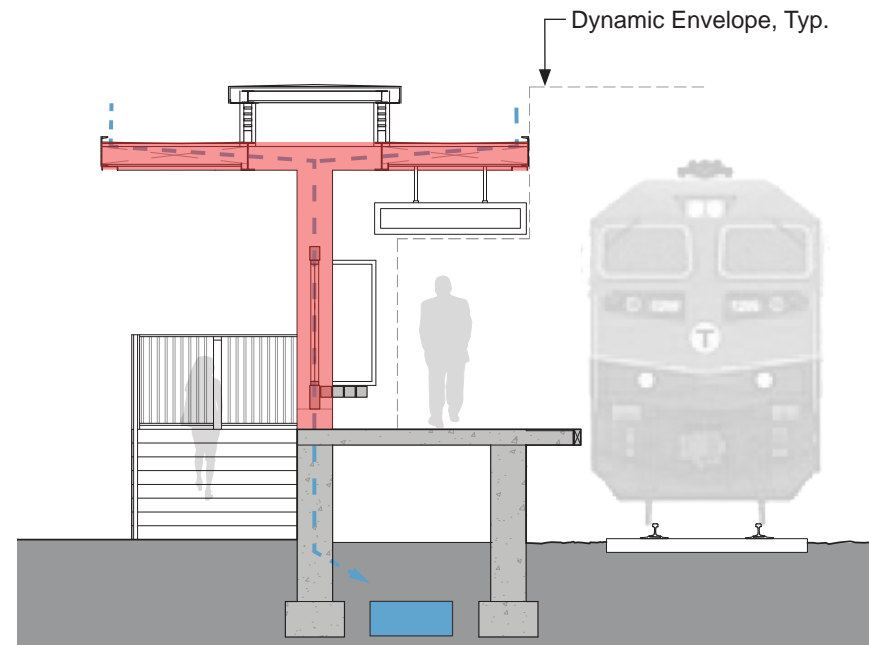

Flat Roof Canopy Option

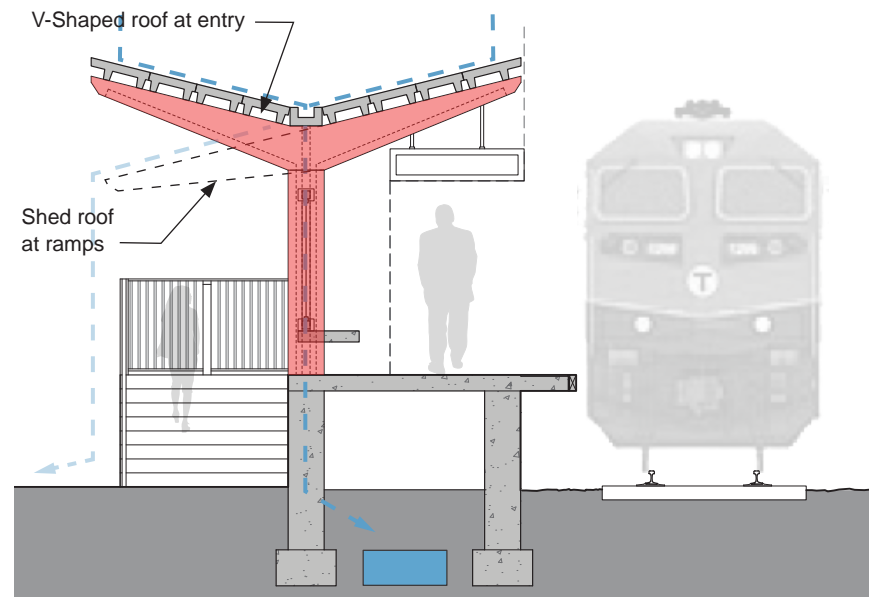

Sloped Wing Canopy Option

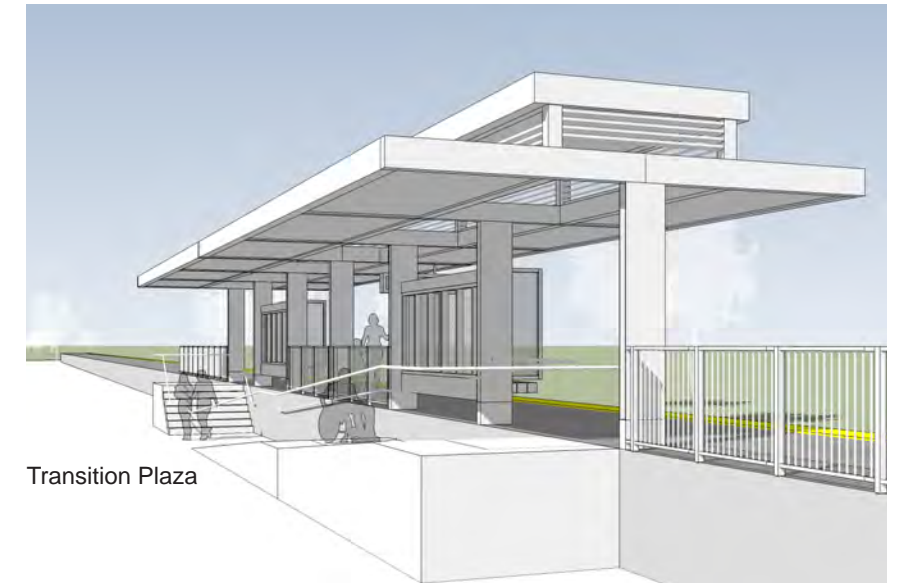

Transition Plaza

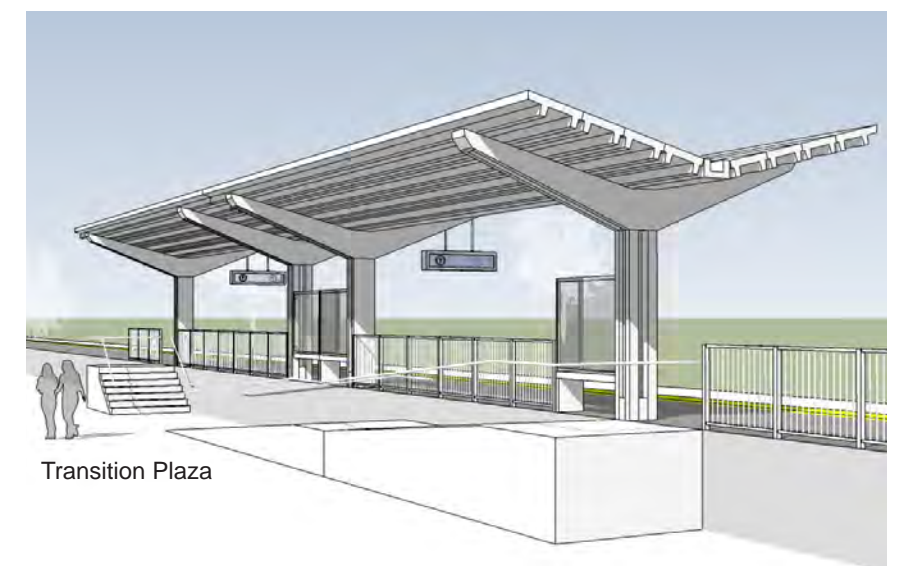

Transition Plaza

← Curb

Track →



### Center Island Platforms Stations

Center Island platform canopies are found at North Easton, Raynham Place, Taunton Depot, and Middleborough/Lakeville stations. A V-shaped, double-winged canopy, similar to the grade-separated transition plaza roofs - except without the shed - was compelling for several reasons with regards the Design Criteria.

Particularly positive characteristics of this approach are: the upturned roof eliminates a drip-edge along the platform edge; a slope encourages debris to be washed off more easily than does the flat option; and locating vertical structural supports at the center of the platform minimize the obstructions to passenger flow and maximize the unobstructed area on the platform. Unlike the side platform stations, rainwater would be collected in gutters all along the platform and channeled to collection areas below.

A key difference with the side island canopies is that these architectural elements are connected to ramps, stairs, and elevators associated with bridge structures to provide continuous cover for passengers on their way to and from the parking lot. The interface of the canopy with the vertical transportation systems (ramps, stairs, and elevators) will be explored in detail during the next phase of design when those systems will be designed. A separate report will be issued at that time.

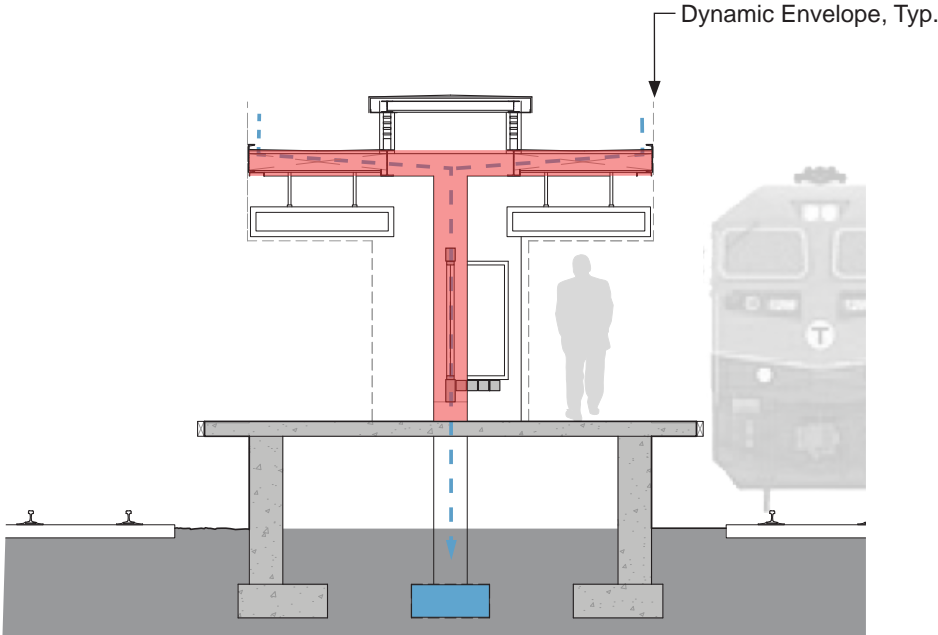

Flat Roof Canopy Option

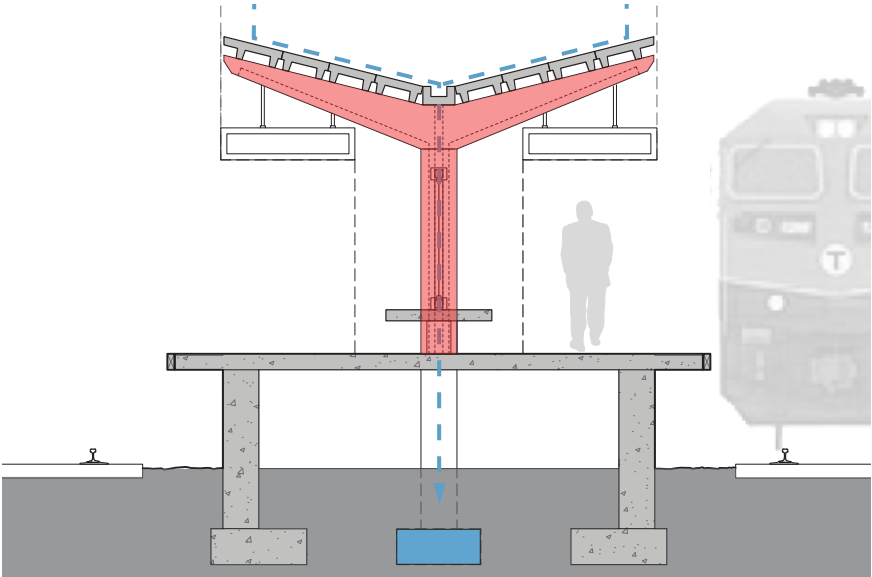

Sloped Wing Canopy Option



## 5.0 Recommendations

### 5.1 Material Matrix

The Material Matrix (Figures 1 and 2) was developed through an ongoing dialogue between the PM CM team and the MBTA as a way to easily visualize the performance of the materials presented in Section Three of this report. Three parameters are evaluated in the matrix: costs, maintenance periods, and performance. The Matrix is organized with the material or system under consideration in the left column and the criteria it is being judged against running along the top row. Each metric is derived from the *Design Criteria* or emerged through conversations with various departments within the MBTA. Each material or system's performance is rated as being either good, neutral, or poor. The initial and life-cycle costs for the canopies are not meant to convey precise "real costs", but rather serve to highlight order of magnitude costs in relation to other materials or systems under consideration. The maintenance periods are a subjective synthesis of published literature, information from vendors, and direct observation of current MBTA stations.

### 5.2 Material Recommendations

Many materials were investigated in the production of this report, with the most promising summarized in Section Three. Some materials were easily eliminated. Heavy timber canopy frames, for example, didn't measure up to the need for durable materials, even though it is aesthetically pleasing and a renewable resource. Also for canopy frames, FRP exhibited exceptional corrosion resistance, but would likely face code compliance hurdles that limited its appeal. Other materials like UHPC, particularly when used with fiber reinforcing, were difficult to eliminate entirely from consideration for canopy frames because they offered appealing characteristics, but lacked a long track record. Given that, it is recommended that final designers revisit material choices should new information become available. With the information currently available, the following are recommended:

**Platforms: Fiber Reinforced Polymer (FRP)** is recommended for platform surfaces. This composite material has been installed on several stations throughout the U.S. over the past 17 years and the material properties remained unchanged, with practically no maintenance requirements. FRP has been proven to be consistent in material under any weather conditions, and resistant under any chemical deicing treatments on the deck.

(NOTE: Due to ongoing code issues with the State Building Inspector's Office, the likelihood of approval of FRP is limited for center island platforms. Based on this, the alternative recommended platform material for center island platforms is UHPC.)

**Canopy Frames: Steel with a 3-part fluoropolymer system** ('TNEMEC' as basis-of-analysis for this report) or **Steel with Metalizing** represent good value and will likely result in lowest overall maintenance demands, while achieving good aesthetic and sustainable marks. While metalizing has historically had quite high initial costs, current pricing indicates that prices have become more competitive. The PM CM team also believes **Aluminum with an anodized or powder coat finish** is a promising option when considering a possible single source scenario paired with Translucent Structural panels. Current pricing shows aluminum to be a cost-effective option, but steel vs. aluminum pricing is subject to frequent fluctuation due to both global markets and local capabilities at the time of bidding.

**Canopy Roofs: Structural Composite Sandwich Panels** ('Kalwall Open Canopy' as basis-of-analysis). The PM CM team believes this product offers compelling benefits for the SCR project - detailed in Section Four of this report - but recommends getting an early review from the Authority Having Jurisdiction if used in the final design. Note: Translucent Structural Panels will need to be specified to meet UL790 and Class A certified.

**Structural Metal Deck with Zinc Standing Seam Roof** is also recommended by the PM CM team. It should be noted that the life span of this built-up roof system is dependent on careful detailing and construction in order to provide adequate ventilation.

Platform Slabs	Initial Cost	Life-cycle Cost	Routine Maintenance	Durability	Constructability	Structural Character	Sustainability	Aesthetics	Special requirements/ considerations
			Cost of Maint. Frequency of Maint. Ease of Maint.	Impact Resistance Vandal Resistance Corrosion Resistance Ease of Repair	Quality Control Contractor Pool Ease of Transport Ease of Assembly	Spanning Capacity Strength-to-Weight Support Syst. Flexibility Joint Connectivity	Recycled Content Recyclability Renewable Resource	User Experience Design Flexibility Appearance Over Time	
<b>Slab Material</b>									
➔ 1. Fiber Reinforced Polymer (FRP)	\$\$\$*	\$	●●●	●●●○	●●●●	●●●○**	●○○○	●●●	* Price includes non-slip polymer overlay, cross-slope for water runoff, factory attached rub strips, factory attached tactile warning tiles, and attachments for railings, benches, etc. ** Shiplap panel joint - offered by some manufacturers - eliminates fillers and offers superior alignment, at slightly higher cost
2. Precast Slabs	\$\$	\$\$	○○●	○○○●	●●○○	○○●○	●○○○	●●○	
➔ 3. UHPC Slabs	\$\$\$\$	\$	●●●	●●●●	●●○○	●○○○	●○○○	●●●	
4. CIP Slabs	\$	\$\$\$	●●●	●●●●	●●●●	●●●●	●●○	●○●	

Fig. 1 (Material Matrix - Platform Slabs)

#### MATRIX KEY

\$	\$\$	\$\$\$\$	●	○	●	➔
INEXPENSIVE	-	EXPENSIVE	GOOD	NEUTRAL	POOR	RECOMMENDED

Canopy System	Initial Cost	Life-cycle Cost	Routine Maintenance [Years]	Durability Impact Resistance Vandal Resistance Corrosion Resistance Ease of Repair	Constructability Quality Control Contractor Pool Ease of Assembly Ease of Customization Ease of Transport	Structural Character Spanning Capacity Strength-to-Weight	Sustainability Recycled Content Recyclability Renewable Resource Solar Reflective Index	Aesthetics User Experience Design Flexibility Appearance Over Time	Special requirements/ considerations
---------------	--------------	-----------------	--------------------------------	--	--	---	---	---	--------------------------------------

### Canopy Structure

#### 1. Steel

a. w/ galvanized finish	\$*	\$\$\$	10-15*	●●●* **	●●●●●	●●	●●●○	●●●	* Initial costs, routine maintenance, and corrosion resistance is dependent on galvanizing thickness. ** Field touch-ups are less durable and difficult to match.
b. w/ duplex finish system	\$\$	\$\$	10-15*	○ ○ ** *	●●●●●	●●	●●●○	● ○ ○ *	* Routine maintenance, corrosion resistance, and appearance depends on proper and thorough surface preparation before final coat is applied. (Prone to peeling and loss of luster.) ** Clear topcoat enhances graffiti resistance.
⇒ c. w/ 'TNEMEC' (3-part Fluoropolymer System)	\$\$\$\$	\$\$	15-20+	●●●●●	○ ●●●* ●	●●	●●●○	●●●●	* Structural shapes should be limited to those where all surfaces are exposed.
⇒ d. w/ Metalizing	\$\$\$	\$\$	20+***	○ ●●●**	○ ○ ●●* ●	●●	●●●○	●●○***	* Structural shapes should be limited to those where all surfaces are exposed. ** Requires skilled technicians to maintain beyond topcoat. *** Routine maintenance and appearance over time depend on proper thickness of material.

#### 2. Aluminum

a. w/ Anodizing	\$\$	\$\$	15-20+*	●●●○●	○** ●●●●●	●●	●●●○	● ○***	* Salt-rich environment can reduce lifespan ** Surface preparation is important for uniform appearance. *** Aesthetics may be poor if single-source option is pursued.
⇒ b. w/ Paint / Powder-Coat	\$\$	\$\$	10-15	○ ○ ●●	← Similar to Anodized →			● ○***	

### Roof Systems

1. Galvanized corrugated metal panel roof on galvanized C-channel purlins*	\$	\$\$\$	15 +/-	○ ○ ●** ●	●●●●○●	○ ○	●●●●	● ○ ●	* Not recommended for use with Aluminum ** Extended life if painted
⇒ 2. Translucent Structural Panels	\$\$\$	\$\$	20+	● ○ ●●	●●●●○●	●●	○ ●●●	●●●●	
⇒ 3. Structural metal deck with zinc standing seam roof	\$\$	\$\$	20+*	○ ●●●	○ ●●●●●	●●	●●●●	○ ●●●	* Lifespan dependent on careful ventilation
4. Structural wood deck with zinc standing seam roof	\$\$\$\$	\$\$	20+	●●●●	○ ●●●●●	● ○	○ ●●●	●●●○	

Fig. 2 (Material Matrix - Canopies)

#### MATRIX KEY

\$	\$\$	\$\$\$\$	●	○	●	⇒
INEXPENSIVE	-	EXPENSIVE	GOOD	NEUTRAL	POOR	RECOMMENDED

## 5.0 Recommendations

### 5.3 Cost Considerations

The cost estimate prepared by Keville confirmed some assumptions and research done by the PM CM team, and contradicted others. In particular, the cost of metallizing for steel canopy framing came in significantly lower than projected, making this coating technology worthy of further consideration. Similarly, the price of zinc roofing over structural metal deck makes this roofing system attractive, with potential for considerable cost savings.

The chart provided in Fig. 3 is an initial comparison of cost differences between the baseline and various recommended canopy systems, as priced for one 150' long canopy.

While certain materials are compelling for use when viewed on their own, others may prove more sensible choices when considered as part of a system. For example, a structural steel deck, such as Epicore, works logically when paired with a steel canopy structure, thus avoiding the

difficulties of separating dissimilar metals. Additionally, translucent roof panel manufacturers often have relationships with aluminum manufacturers, which means combining the two materials has the potential for the cost savings of single-source fabrication and delivery. However, preliminary research found that the single-source procurement method will likely limit the aesthetics of the aluminum members. One such partnership explored uses a pre-engineered aluminum system that affords very little aesthetic choice. Further research into the possibility and price-implications of a custom aluminum structure will need to be conducted.

Canopy System	Cost per 150' Canopy	
<b>Baseline (Duplex Steel + Corrugated Metal Deck)</b>		
Steel Columns- Single	\$18,440	
Steel Columns- Double	\$300,400	
Corrugated Metal Deck Roof	\$180,000	
	\$498,840	
<b>Steel (Tnemec) and Structural Metal Deck + Zinc*</b>		
Steel Columns- Single	\$22,150	
Steel Columns- Double	\$401,600	
Structural Metal + Zinc Roof	\$165,000	
	\$588,750	118% of Baseline Cost
<b>Steel (Tnemec) and Translucent Panel</b>		
Steel Columns- Single	\$22,150	
Steel Columns- Double	\$401,600	
Translucent Panel Roof	\$243,000	
	\$666,750	134% of Baseline Cost
<b>Steel (Metalizing) and Structural Metal Deck + Zinc*</b>		
Steel Columns- Single	\$21,250	
Steel Columns- Double	\$354,200	
Structural Metal + Zinc Roof	\$165,000	
	\$540,450	108% of Baseline Cost
<b>Steel (Metalizing) and Translucent Panel</b>		
Steel Columns- Single	\$21,250	
Steel Columns- Double	\$354,200	
Translucent Panel Roof	\$243,000	
	\$618,450	124% of Baseline Cost

\* Zinc pricing to be updated to include water-proofing membrane, fire-rated plywood substrate, and drainage mat.

Canopy System	Cost per 150' Canopy	
<b>Single Sourced Components**</b>		
<b>Aluminum and Translucent Panel</b>		
Single Pitch Roof Area	\$26,350	
Double Pitch Roof Area	\$427,330	
	\$453,680	91% of Baseline Cost
<b>Multi-Sourced Components</b>		
<b>Aluminum (Anodized) and Translucent Panel</b>		
Aluminum Columns- Single	\$19,860	
Aluminum Columns- Double	\$352,300	
Translucent Panel Roof	\$243,000	
	\$615,160	123% of Baseline Cost
<b>Aluminum (Powder Coat) and Translucent Panel</b>		
Aluminum Columns- Single	\$20,480	
Aluminum Columns- Double	\$376,400	
Translucent Panel Roof	\$243,000	
	\$639,880	128% of Baseline Cost

\*\* Single-source savings to be further verified.

Fig. 3 (Material Matrix - Canopy Cost Comparison) Costs based on estimated prepared by Keville Enterprises - See Appendix

When analyzed in the larger context of the overall station value, the cost difference between the baseline canopy and the most expensive canopy is only 3.5%. The chart in Fig. 4 shows the difference between the baseline canopy option and the most expensive canopy option, as a percentage of the entire station cost. In the baseline version, the canopy comprises 17% of the overall station cost, while the most expensive canopy option comes in at 21.5%. Considering this, the team recommends making an initial investment in higher-quality canopy material, as this will be directly related to future maintenance costs and will ultimately determine the success and longevity of the project.

The final choice between recommended materials will depend upon more in-depth cost estimates based on detailed specifications, and, ultimately, how the client prioritizes the categories shown on the cost matrix.

**Typical Station**

**Cost per Typical Station**

<b>Baseline Canopy (Duplex Steel + Corrugated Metal Deck)</b>			
Steel Columns- Single	1	\$18,440.00	\$18,440.00
Steel Columns- Double	10	\$30,040.00	\$300,400.00
Gutter & Downspout	130	\$28.00	\$3,640.00
Roof	3000	\$60.00	\$180,000.00
Stairs	1	\$31,397.00	\$31,397.00
Foundations	11	\$6,528.00	\$71,808.00
			\$605,685.00
Platform			
Slab	9600	\$100.00	\$960,000.00
Railing	800	\$251.00	\$200,800.00
Framing and Foundations	800	\$995.00	\$796,000.00
Ramp 75ft lg	1	\$124,759.00	\$124,759.00
			\$2,081,559.00
Site Work (Assumed)			
Mobilization, Excavation, and Backfilling	0.15	\$2,687,244.00	\$403,086.60
			\$403,086.60

Total Cost \$3,090,330.60  
 Unit Cost (\$/SF) \$321.91  
*Canopy Cost, Foundations Excluded* \$533,877.00  
*% of Canopy Cost* 17%

<b>Most Expensive Canopy (Tnemec Steel and Translucent Panel)</b>			
Steel Columns- Single	1	\$22,150.00	\$22,150.00
Steel Columns- Double	10	\$40,160.00	\$401,600.00
Gutter & Downspout	130	\$28.00	\$3,640.00
Roof	3000	\$81.00	\$243,000.00
Stairs	1	\$31,397.00	\$31,397.00
Foundations	11	\$6,528.00	\$71,808.00
			\$773,595.00
Platform			
Slab	9600	\$100.00	\$960,000.00
Railing	800	\$251.00	\$200,800.00
Framing and Foundations	800	\$995.00	\$796,000.00
Ramp 75ft lg	1	\$124,759.00	\$124,759.00
			\$2,081,559.00
Site Work (Assumed)			
Mobilization, Excavation, and Backfilling	0.15	\$2,687,244.00	\$403,086.60
			\$403,086.60

Total Cost \$3,258,240.60  
 Unit Cost (\$/SF) \$339.40  
*Canopy Cost, Foundations Excluded* \$701,787.00  
*% of Canopy Cost* 21.5%

Fig. 4 (Material Matrix - Station Cost Comparison) Costs based on estimated prepared by Keville Enterprises - See Appendix

## 5.0 Recommendations

### 5.4 Form Recommendations

#### Platforms

The recommended slab for the high platforms, FRP, is flexible in terms of supporting structure.

At side platforms, steel beams on one end and a retaining wall on the other end is the recommended support structure. The retaining wall will allow for any grade elevation adjacent to the wall. Steel beams are easy to install and require low maintenance. Steel beams shall be supported on piers on spread footings. Where micropiles are recommended, steel beams and retaining walls shall be supported on pile caps, which in turn are supported on micropiles.

At center platforms, FRP supported by steel beams on each end is the recommended high platform structure. Steel beams shall be supported on piers on spread footings or on pile caps, which in turn are supported on micropiles. This type of foundation has less impact on existing tracks during installation than the conventional spread footings.

An alternative to steel beams may be the retaining walls supported by strip footings. The advantage is that the retaining walls would block any accumulation of debris under the platform.

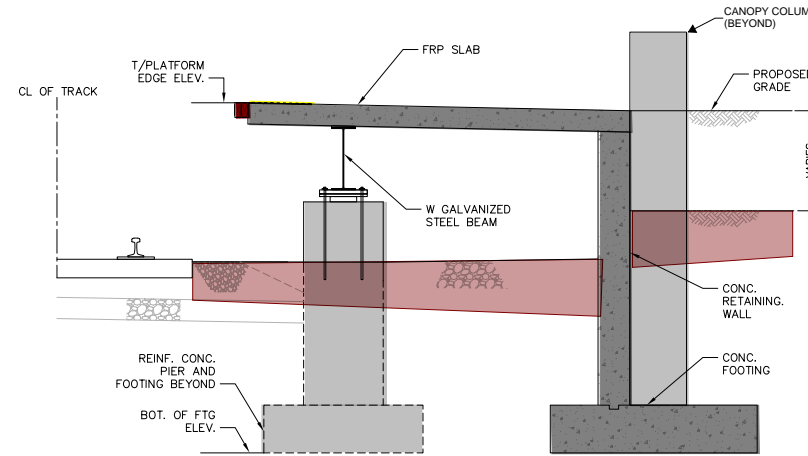

**Side Platforms**  
(FRP supported by walls on strip footings)

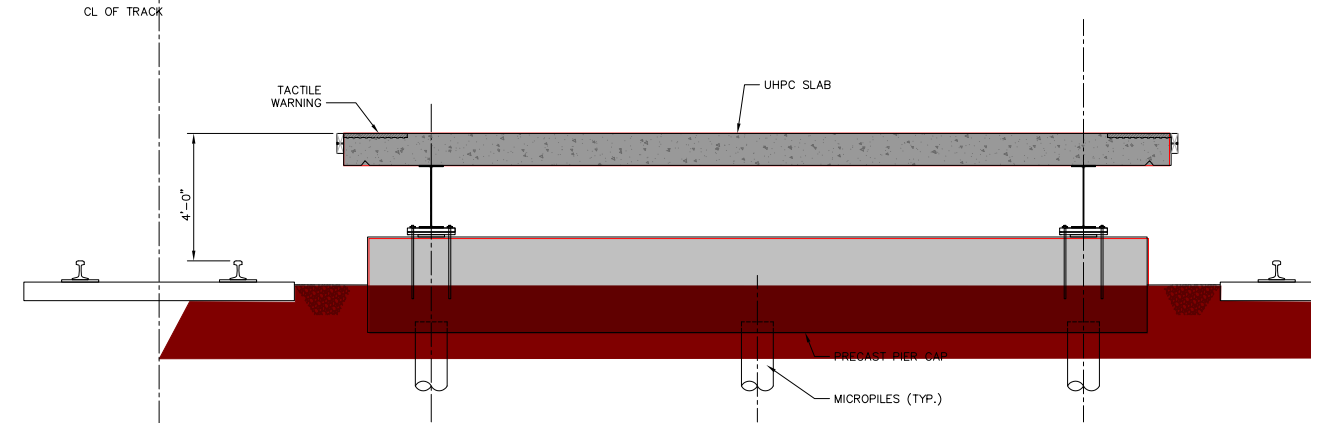

**Center Island Platforms**  
FRP supported by steel beams on Piles)

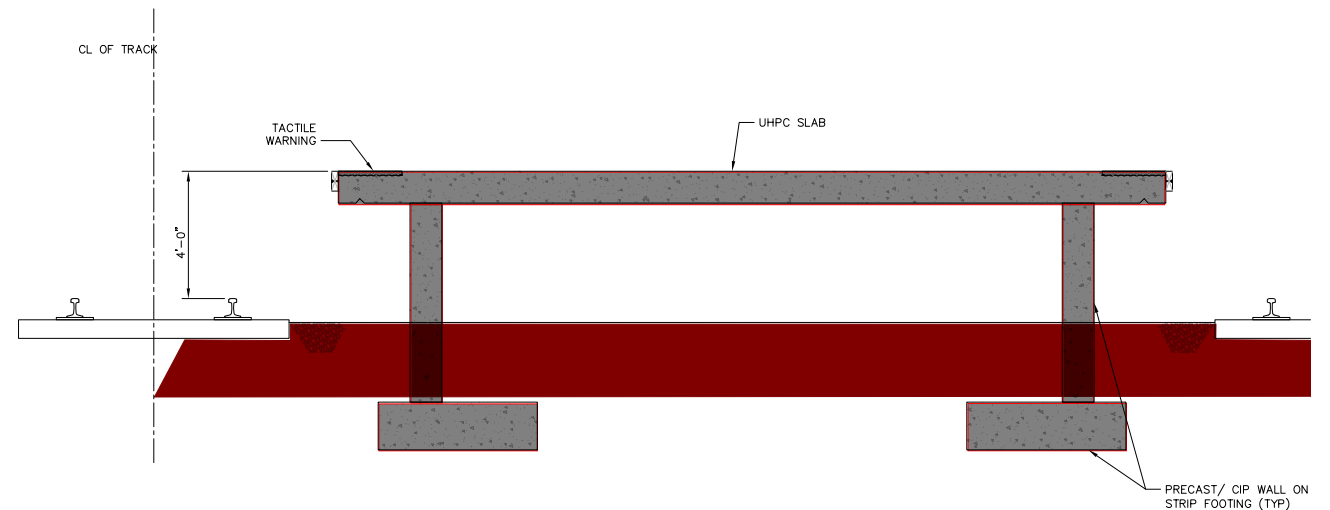

**Center Island Platforms - Alternative**  
FRP supported by walls on strip footings)

**Canopies**

**Section A** is recommended along side platform stations in both flush and grade-separated type stations. This form allows the roof to drain directly into landscaped areas adjacent to the platform without the use of gutters. Without gutters, the drip edge of the platform will need to be detailed in such a way as to protect the passengers from shedding water. Holding the columns off the platform will provide additional length of weather protection as well as help to free up space on the platform. The addition of windscreens will further protect passengers from the elements.

**Section B** is recommended for center island platforms canopies as well as at Transition Plaza entrances for both types of side platform stations (flush and grade-separated). The V-shaped roof signifies entry and prevents a drip-edge where passengers enter the platform at side platform stations. This section would require internal gutters to collect and remove rainwater from the roof. If conditions permit, the rain leaders at side platform stations could drain to adjacent landscaped areas, but center island platforms would be collected in a system located under the platform.

**Section C** occurs at ramps located at the Transition Plaza of grade-separated side platform stations only. Where site conditions permit, this roof would drain directly to adjacent landscaping without a gutter, similar to Section A. Due to the roof extension passengers on the platform are well protected from the elements.

**Column Bases:** In all cases, the PM CM team recommends mounting the columns on concrete piers held above the platform elevation. This approach is more durable than anchoring the column at platform height, reducing the potential for damage to the columns.

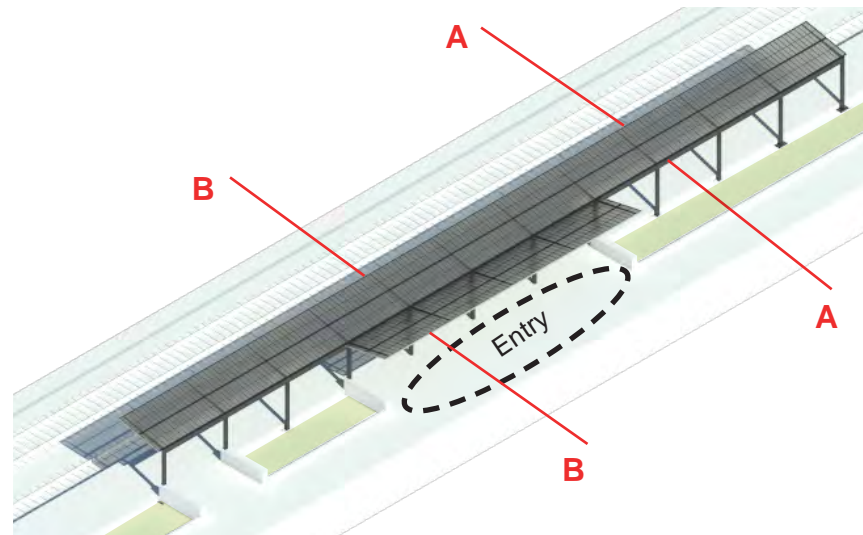

**Typical Flush Transition Plaza Station**  
(Ex. Taunton, Kings Highway and Battleship Cove)

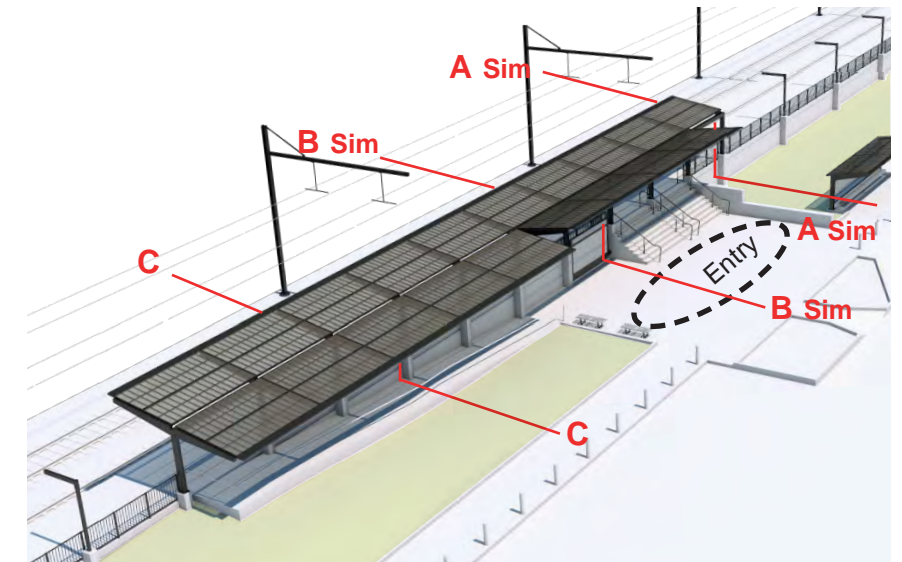

**Typical Grade Separated Transition Plaza Station**  
(Ex. Freetown, Whale's Tooth, Fall River Depot)

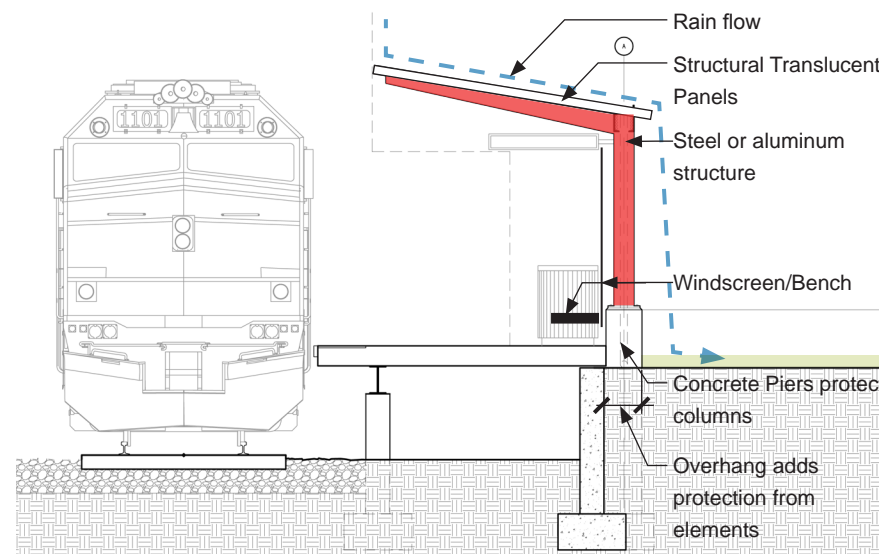

**Section A: Single-Wing Canopy**  
(Side Platform at Flush and Grade-Separated Stations)

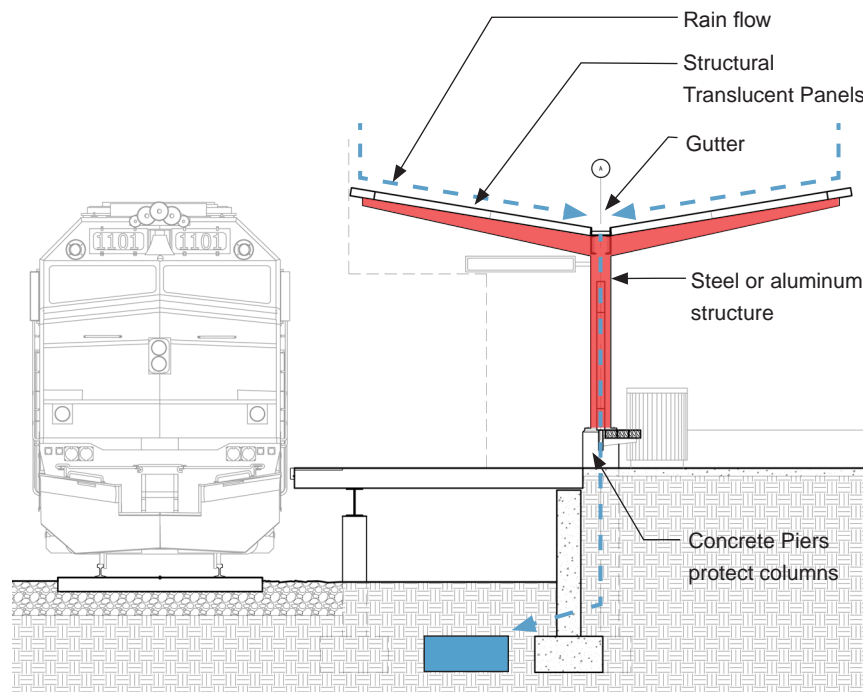

**Section B: Double-Wing Canopy**  
(Center Island Platforms and Side Platform Entries)

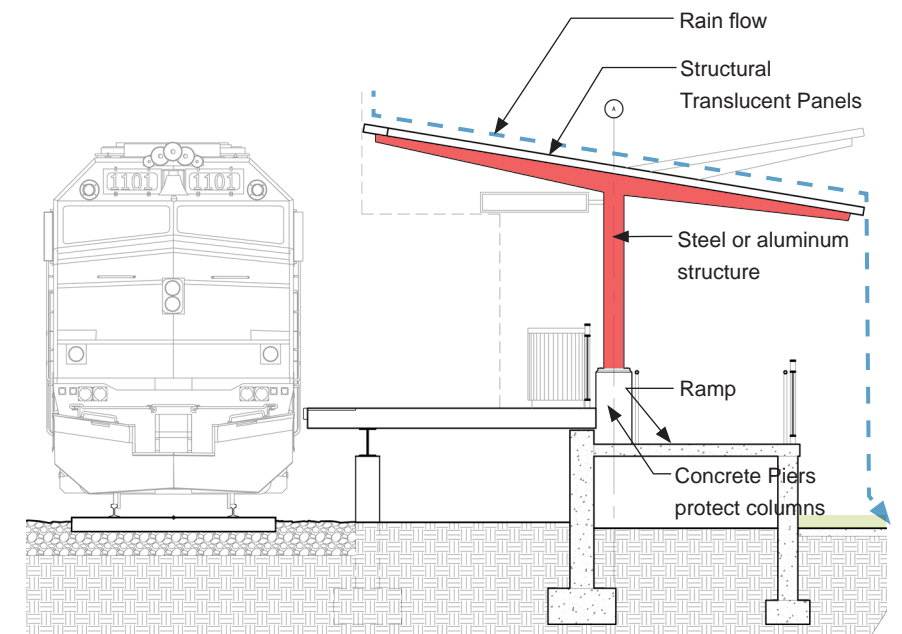

**Section C: Shed Canopy**  
(Side Platform at Grade-Separated Station Ramps)

## 5.0 Recommendations

### 5.4 Form Recommendations

#### Flush Platform Station

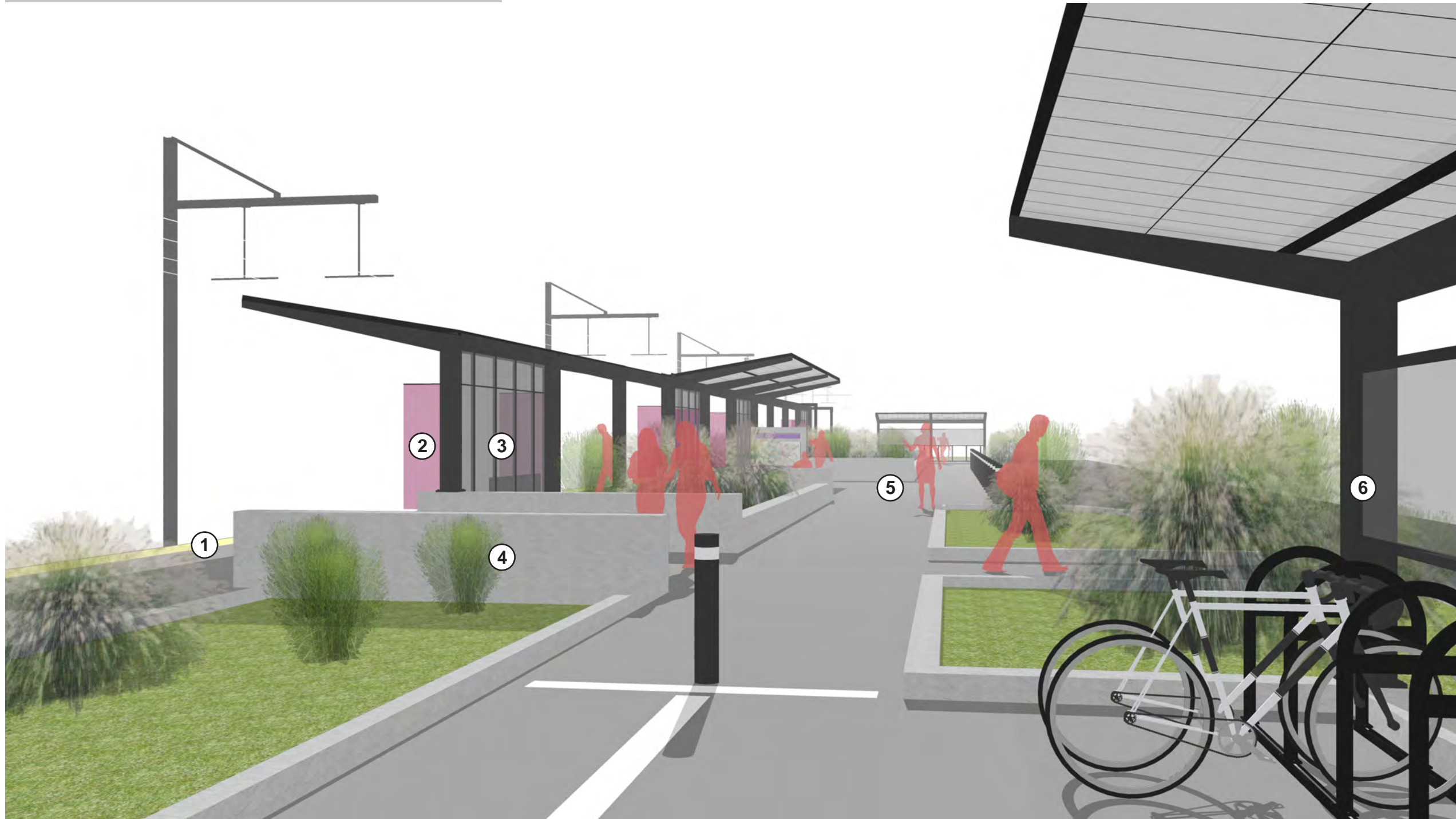

Fig. 5 Typical Flush Platform Station

1. Platform Tactile Warning Strip 2. Bench Windscreen (Design Team to explore materiality and possibility of incorporating color) 3. Architectural Mesh Windscreen at Bench 4. Cast-In-Place Landscape Wall 5. Transition Plaza 6. Bike Storage



Grade-Separated Platform Station



Fig. 6 Typical Grade-Separated Platform Station

1. Bench Windscreen 2. Architectural Mesh Windscreen at Bench 3. Shed Canopy at Ramp 4. Landscaped Area 5. Double Wing Canopy at Stair and Platform Entry 6. Cast-In-Place Landscape Wall 7. Transition Plaza 8. Bike Storage

## 5.0 Recommendations

### 5.5 Code Compliance Review

Code and accessibility issues play a significant role in determination of both material choice and station forms and layouts. NFPA 130, the Standard for Fixed Guideway Transit and Passenger Rail Systems (2010) and 780 CMR State Building Code are the primary applicable code standards. For a detailed code and accessibility analysis, refer to South Coast Rail Extension Code Summary Report, prepared by AKF in October of 2014. Further code reviews will be provided after drawing submissions.

*This page intentionally left blank.*

**6.0 Appendix - Cost Estimate**

Prepared by:  
Keville Enterprises for  
VHB

**South Coast Rail  
Rail Side Stations  
Platform - Canopy - Slab - Foundation - Ramps and Stairs  
Study Estimate**

11/2/2016

Line no.		Location	Material	Finish		Qty	Unit	Unit Cost	Option Unit Cost
4									
5	1-1a	Canopy	steel	galvanized	Single-wing canopy arm	1	ea		\$ 18,440
6					HSS 10x10x1/4 columns	8	ft	\$ 1,131.67	
7					WT10.5x36.5 cantilever	10	ft	\$ 938.42	
8									
9	1-1b	Canopy	steel	duplex finish system	Single-wing canopy arm	1	ea		\$ 20,090
10					hot-dip galv. & Colorgalv10 epoxy/polyurethane				
11									
12					HSS 10x10x1/4 columns	8	ft	\$ 1,217.93	
13					WT10.5x36.5 cantilever	10	ft	\$ 1,035.00	
14									
15	1-1c	Canopy	steel	TNEMEC 3-part fluoropolymer system	Single-wing canopy arm	1	ea		\$ 22,150
16					HSS 10x10x1/4 columns	8	ft	\$ 1,303.48	
17					WT10.5x36.5 cantilever	10	ft	\$ 1,171.93	
18									
19	1-1d	Canopy	steel	metalizing + 1 coat of paint	Single-wing canopy arm	1	ea		\$ 21,250
20					- 8-step process				
21					HSS 10x10x1/4 columns	8	ft	\$ 1,183.72	
22					WT10.5x36.5 cantilever	10	ft	\$ 1,011.78	
23					site touch-up of metalized surfaces w/non-metalized zinc coating	8	hr	\$ 208.10	
24									
25	1-2a	Canopy	aluminum	anodized	Single-wing canopy arm	1	ea		\$ 19,860
26					10x10 columns	8	ft	\$ 1,234.96	
27					WT10.5 cantilever	10	ft	\$ 998.03	
28									
29	1-2b	Canopy	aluminum	paint w/powder coat	Single-wing canopy arm	1	ea		\$ 20,480
30					10x10 columns	8	ft	\$ 1,272.01	
31					WT10.5 cantilever	10	ft	\$ 1,030.53	
32									

**South Coast Rail  
Rail Side Stations  
Platform - Canopy - Slab - Foundation - Ramps and Stairs  
Study Estimate**

11/2/2016

Line no.		Location	Material	Finish		Qty	Unit	Unit Cost	Option Unit Cost
<b>33</b>	<b>2-1a</b>	<b>Canopy</b>	<b>steel</b>	<b>galvanized</b>	<b>Double-wing canopy arm</b>	<b>1</b>	<b>ea</b>		<b>\$ 30,040</b>
34					HSS 14x6x1/4 columns	8	ft	\$ 1,131.67	
35					WT10.5x36.5 cantilever	20	ft	\$ 938.42	
36					C10x15.3 steel gutter & downspout @30ft. o.c.	40	lf	\$ 55.37	
37									
<b>38</b>	<b>2-1b</b>	<b>Canopy</b>	<b>steel</b>	<b>duplex finish system</b>	<b>Double-wing canopy arm</b>	<b>1</b>	<b>ea</b>		<b>\$ 34,280</b>
39					hot-dip galv.				
40					powder coating				
41					HSS 14x6x1/4 columns	8	ft	\$ 1,217.93	
42					WT10.5x36.5 cantilever	20	ft	\$ 1,035.00	
43					C10x15.3 steel gutter & downspout @30ft. o.c.	40	lf	\$ 95.86	
44									
<b>45</b>	<b>2-1c</b>	<b>Canopy</b>	<b>steel</b>	<b>TNEMEC 3-part fluoropolymer system</b>	<b>Double-wing canopy arm</b>	<b>1</b>	<b>ea</b>		<b>\$ 40,160</b>
46					HSS 14x6x1/4 columns	8	ft	\$ 1,303.48	
47					WT10.5x36.5 cantilever	20	ft	\$ 1,171.93	
48					C10x15.3 steel gutter & downspout @30ft. o.c.	40	lf	\$ 157.24	
49									
<b>50</b>	<b>2-1d</b>	<b>Canopy</b>	<b>steel</b>	<b>metalizing</b>	<b>Double-wing canopy arm</b>	<b>1</b>	<b>ea</b>		<b>\$ 35,420</b>
51					8-step process				
52					HSS 14x6x1/4 columns	8	ft	\$ 1,183.72	
53					WT10.5x36.5 cantilever	20	ft	\$ 1,011.78	
54					C10x15.3 steel gutter & downspout @30ft. o.c.	40	lf	\$ 99.11	
55					site touch-up of metalized surfaces w/non-metalized zinc coating	8	hr	\$ 218.63	
56									

**South Coast Rail  
Rail Side Stations  
Platform - Canopy - Slab - Foundation - Ramps and Stairs  
Study Estimate**

11/2/2016

Line no.		Location	Material	Finish		Qty	Unit	Unit Cost	Option Unit Cost
57	2-2a	Canopy	aluminum	anodized	Double-wing canopy arm	1	ea		\$ 35,230
58					HSS 14x6 columns	8	ft	\$ 1,306.41	
59					WT10.5 cantilever	20	ft	\$ 967.17	
60					C10x15.3 steel gutter & downspout @30ft. o.c.	40	lf	\$ 136.00	
61									
62	2-2b	Canopy	aluminum	paint w/powder coat	Double-wing canopy arm	1	ea		\$ 37,640
63					HSS 14x6 columns	8	ft	\$ 1,363.86	
64					WT10.5 cantilever	20	ft	\$ 999.67	
65					C10x15.3 steel gutter & downspout @30ft. o.c.	40	lf	\$ 168.51	
66									
67	1	Roof	corrugated metal deck	galvanized	Deck and Support Structure	1	sf		\$ 60.00
68					1 1/2" 20ga. corr. metal deck	1,050	sf	\$ 26.19	
69					C6x13 purlins, 2ft. o.c. <b>potential bird collection</b>	600	lf	\$ 54.76	
70					perimeter flashing	221	lf	\$ 11.19	
71									
72	2	Columns, Canopy and Roof	Translucent structural panels and aluminum columns - Kalwall	Single Wing Single Source	Deck and Support Structure - Single Wing	1	sf		\$ 155.00
73					Kalwall canopy and column system	1,050	sf	\$ 155.00	
74									
75	2	Columns, Canopy and Roof	Translucent structural panels and aluminum columns - Kalwall	Double Wing Single Source	Deck and Support Structure - Double Wing	1	sf		\$ 151.00
76					Kalwall canopy and column system	2,100	sf	\$ 150.73	
77					downspouts excluded				
78									

**South Coast Rail  
Rail Side Stations  
Platform - Canopy - Slab - Foundation - Ramps and Stairs  
Study Estimate**

11/2/2016

Line no.		Location	Material	Finish		Qty	Unit	Unit Cost	Option Unit Cost
<b>79</b>	<b>3</b>	<b>Roof</b>	<b>5" metal deck with zinc stand seam roof</b>		<b>Deck and Support Structure</b>	<b>1</b>	<b>sf</b>		<b>\$ 65.00</b>
80					5" 20ga. Epicore roof deck by Epic Metals	1,050	sf	\$ 20.09	
81					epoxy paint in field	1,050	sf	\$ 3.18	
82					polycarbonate insulation	1,050	sf	\$ 2.32	
83					zinc standing seam roof	1,050	sf	\$ 39.56	
84					perimeter flashing	-	lf		
85									
<b>86</b>	<b>3</b>	<b>Roof</b>	<b>4" metal deck with zinc stand seam roof</b>		<b>Deck and Support Structure</b>	<b>1</b>	<b>sf</b>		<b>\$ 55.00</b>
87					4" G90 galv. 2-coat prime painted 20ga. Toris roof deck by Epic Metals	1,050	sf	\$ 10.09	
88					epoxy paint in field	1,050	sf	\$ 3.18	
89					polycarbonate insulation	1,050	sf	\$ 2.32	
90					zinc standing seam roof	1,050	sf	\$ 39.56	
91					perimeter flashing	-	lf		
92									
<b>93</b>	<b>4</b>	<b>Roof</b>	<b>structural wood deck with zinc standing seam roof</b>		<b>Deck and Support Structure</b>	<b>1</b>	<b>sf</b>		<b>\$ 116.00</b>
94					structural 3x6 wood deck	1,050	sf	\$ 76.73	
95					zinc standing seam roof	1,050	sf	\$ 39.56	
96					perimeter flashing	221	lf	\$ 11.19	
97									
98									
<b>99</b>	<b>1</b>	<b>Slab</b>	<b>Polymer panels - FRP</b>		<b>Slab</b>	<b>1</b>	<b>sf</b>		<b>\$ 97.00</b>
100					slab size - 100 x 12 x 10"th	1,200	sf	\$ -	
101					fab. & deliver precast panels	13	ea	\$ 7,449.51	
102					place panels	13.00	ea	\$ 965.79	
103					tactile warning strip, installed in shop	200	sf	\$ -	
104					rub rail, installed in shop	100	lf	\$ 71.82	

**South Coast Rail  
Rail Side Stations  
Platform - Canopy - Slab - Foundation - Ramps and Stairs  
Study Estimate**

11/2/2016

Line no.		Location	Material	Finish		Qty	Unit	Unit Cost	Option Unit Cost
105									
<b>106</b>	<b>2</b>	<b>Slab - Elevated</b>	<b>Polymer (Pre-Engineered Composite) panels - Armor Deck</b>		<b>Slab - Elevated</b>	<b>1</b>	<b>sf</b>		<b>\$ 108.00</b>
107					slab size - 100 x 12 x 10"th	1,200	sf	\$ -	
108					fab. & deliver panels	20	ea	\$ 5,556.60	
109					place panels; incl. tactile warning strips	20.00	ea	\$ 505.06	
110					rub rail, installed in shop	100	lf	\$ 83.38	
111									
<b>112</b>	<b>3</b>	<b>Slab</b>	<b>Precast concrete</b>		<b>Slab</b>	<b>1</b>	<b>sf</b>		<b>\$ 63.00</b>
113					slab size - 100 x 12 x 10in	1,200	sf	\$ -	
114					slab volume	37.04	cy	\$ -	
115					fab. & deliver precast panels	13	ea	\$ 3,307.50	
116					epoxy coated rebar, in precast #6 @6" o.c., ew top #6@12" o.c., ew bottom				
117					place panels	13.00	ea	\$ 804.83	
118					tactile warning strip, installed during casting	200	sf	\$ 92.64	
119					rub rail, installed during casting	100	lf	\$ 41.13	
120									
<b>121</b>	<b>4</b>	<b>Slab</b>	<b>Ultra-high performance concrete</b>		<b>Slab</b>	<b>1</b>	<b>sf</b>		<b>\$ 106.00</b>
122					slab size - 100 x 12 x 6in	1,200	sf	\$ -	
123					slab volume	22.22	cy	\$ -	
124					fab. & deliver precast panels	13	ea	\$ 6,879.60	



**South Coast Rail  
Rail Side Stations  
Platform - Canopy - Slab - Foundation - Ramps and Stairs  
Study Estimate**

11/2/2016

Line no.		Location	Material	Finish		Qty	Unit	Unit Cost	Option Unit Cost
125					epoxy coated rebar not required				
126					place panels	13	ea	\$ 804.83	
127					tactile warning strip, installed during casting	200	sf	\$ 111.17	
128					rub rail, installed during casting	100	lf	\$ 49.36	
<b>130</b>	<b>5</b>	<b>Slab</b>	<b>CIP</b>		<b>Slab</b>	<b>1</b>	<b>sf</b>		<b>\$ 54.00</b>
131					slab size - 100 x 12 x 10in	1,200	sf	\$ -	
132					form & strip	1,392	sf	\$ 13.10	
133					epoxy coated rebar - 10lb/cf	10,000	lbs	\$ 1.45	
134					place concrete	37.04	cy	\$ 170.59	
135					finish slab	1,200	sf	\$ 0.93	
136					tactile warning strip	200	sf	\$ 99.06	
137					rub rail	100	lf	\$ 45.95	
138						15		\$ -	
<b>139</b>	<b>1</b>	<b>Slab</b>	<b>Radiant Heat</b>		<b>Add to Platform</b>	<b>1</b>	<b>sf</b>		<b>\$ 15.00</b>
140					slab size - 100 x 12	1,200	sf	\$ -	
141					radiant heat	1,200	sf	\$ 15.26	
142									
143									
<b>144</b>	<b>1</b>	<b>Slab Foundation</b>	<b>CIP</b>	<b>back wall on strip footing, steel beam on piers in front</b>	<b>Foundation</b>	<b>1</b>	<b>lf</b>		<b>\$ 956.00</b>
145					excavation & backfill	193	cy	\$ 32.10	
146					6" gravel base	14	cy	\$ 34.40	
147					back continuous footing, 7' x 1'h				
148					form & strip	214	sf	\$ 11.44	
149					rebar, 12#/cf	9,072	lbs	\$ 1.45	
150					place concrete	28	cy	\$ 170.59	
151					back footing wall, 5' x 2' th.				

**South Coast Rail  
Rail Side Stations  
Platform - Canopy - Slab - Foundation - Ramps and Stairs  
Study Estimate**

11/2/2016

Line no.		Location	Material	Finish		Qty	Unit	Unit Cost	Option Unit Cost
152					form & strip	1,020	sf	\$ 12.55	
153					rebar, 12#/cf	12,312	lbs	\$ 1.45	
154					place concrete	38	cy	\$ 170.59	
155					front pier footing, 30ft. o.c.; 6'x6' x 1.5'h	4	ea	\$ -	
156					form & strip	144	sf	\$ 11.44	
157					rebar, 12#/cf	2,592	lbs	\$ 1.45	
158					place concrete	8.00	cy	\$ 170.59	
159					front support piers, 30ft. o.c. 2.5' x 2.5'x5' th.	4	ea	\$ -	
160					form & strip	200	sf	\$ 11.44	
161					rebar, 12#/cf	1,500	lbs	\$ 1.45	
162					place concrete	4.63	cy	\$ 170.59	
163					W21x50	5,000	lbs	\$ 3.87	
164									
165	2	Slab Foundation	CIP	front and back wall on strip footings	Foundation	1	lf		\$ 1,276.00
166					excavation & backfill	325	cy	\$ 32.10	
167					6" gravel base	26	cy	\$ 34.40	
168					back & front continuous footing, 7' x 1'h	100	ft	\$ -	
169					form & strip	428	sf	\$ 11.44	
170					rebar, 12#/cf	16,800	lbs	\$ 1.45	
171					place concrete	51.85	cy	\$ 170.59	
172					back & front footing wall, 8' x 1' th.				
173					form & strip	3,200	sf	\$ 12.55	
174					rebar, 12#/cf	19,200	lbs	\$ 1.45	
175					place concrete	59	cy	\$ 170.59	
176									

**South Coast Rail  
Rail Side Stations  
Platform - Canopy - Slab - Foundation - Ramps and Stairs  
Study Estimate**

11/2/2016

Line no.		Location	Material	Finish		Qty	Unit	Unit Cost	Option Unit Cost
177	3	Slab Foundation	CIP & precast	pile cap, pile and pier foundation w/steel beam on front piers	Foundation	1	lf		\$ 995.00
178					excavation & backfill	35	cy	\$ 32.10	
179					6" gravel base	4	cy	\$ 34.40	
180					foundation per 100 ft. of platform	4	ea	\$ -	
181					3-10" micropiles, 40ft long per pile cap	480	v-ft	\$ 61.21	
182					piledriving mob/demob	1	ea	\$ 7,000.00	
183					pile cap, 30ft. o.c.; 13'x2.5' x 3'h	4	ea	\$ -	
184					form & strip	372	sf	\$ 11.44	
185					rebar, 12#/cf	2,592	lbs	\$ 1.45	
186					place concrete	8.00	cy	\$ 170.59	
187					back piers, 30ft. o.c. 2' x 1.5'x3' th.	4	ea	\$ -	
188					form & strip	84	sf	\$ 11.44	
189					rebar, 12#/cf	432	lbs	\$ 1.45	
190					place concrete	1.33	cy	\$ 170.59	
191					precast beam w/curtainwall at back	100	lf	\$ -	
192					fab. & deliver precast pieces	13	ea	\$ 1,212.75	
193					place precast pieces	13	ea	\$ 804.83	
194					precast to CIP tie pieces, 4/precast, mat'l only	52	ea	\$ 13.23	
195					front support piers, 30ft. o.c. 2.5' x 2.5'x3' th.	4	ea	\$ -	
196					form & strip	120	sf	\$ 11.44	
197					rebar, 12#/cf	900	lbs	\$ 1.45	
198					place concrete	2.78	cy	\$ 170.59	

**South Coast Rail  
Rail Side Stations  
Platform - Canopy - Slab - Foundation - Ramps and Stairs  
Study Estimate**

11/2/2016

Line no.		Location	Material	Finish		Qty	Unit	Unit Cost	Option Unit Cost
199					W21x50	5,000	lbs	\$ 3.87	
200					anchor PL and bolts, cast at each front pier	4	set	\$ 294.15	
201									
<b>202</b>	<b>1</b>	<b>Canopy Foundation</b>	<b>CIP</b>		<b>Foundation</b>	<b>1</b>	<b>ea</b>		<b>\$ 4,431.00</b>
203					excavation & backfill	9	cy	\$ 32.10	
204					6" gravel base	1	cy	\$ 34.40	
205					spread footing, 6' x 6' x 18"h				
206					form & strip	36	sf	\$ 13.08	
207					rebar, 12#/cf	648	lbs	\$ 1.66	
208					place concrete	2.00	cy	\$ 194.96	
209					column, 30" x 30" x 5'h				
210					form & strip	50	sf	\$ 26.08	
211					rebar, 12#/cf	375	lbs	\$ 1.66	
212					place concrete	1.16	cy	\$ 204.98	
213									
<b>214</b>	<b>1</b>	<b>Canopy Foundation</b>	<b>Single pile cap foundation</b>		<b>Foundation</b>	<b>1</b>	<b>ea</b>		<b>\$ 6,528.00</b>
215					excavation & backfill	7	cy	\$ 32.10	
216					6" gravel base	1	cy	\$ 34.40	
217					1-10" micropiles, 40ft long per pile cap	40	v-ft	\$ 61.21	
218					piledriving mob/demob (total cost reflects 1 mob for 400ft platform)	1	ea	\$ 525.00	
219					pile cap, 30ft. o.c.; 6'x6' x 1.5'h				
220					pile cap, 30ft. o.c.; 4'x2.5' x 3'h	1	ea	\$ -	
221					form & strip	39	sf	\$ 11.44	
222					rebar, 12#/cf	360	lbs	\$ 1.45	
223					place concrete	1.11	cy	\$ 170.59	

**South Coast Rail  
Rail Side Stations  
Platform - Canopy - Slab - Foundation - Ramps and Stairs  
Study Estimate**

11/2/2016

Line no.		Location	Material	Finish		Qty	Unit	Unit Cost	Option Unit Cost
224					column pier, 30" x 30" x 5'h				
225					form & strip	50	sf	\$ 26.08	
226					rebar, 12#/cf	375	lbs	\$ 1.66	
227					place concrete	1.16	cy	\$ 204.98	
228									
229									
<b>230</b>	<b>1</b>	<b>Ramp</b>	<b>CIP</b>		<b>Ramp</b>	<b>75</b>	<b>lf</b>		<b>\$ 124,759.00</b>
231					excavation & backfill	35	cy	\$ 32.10	
232					6" gravel base	4	cy	\$ 34.40	
233					75ft long x 8ft wide x 6.5ft. rise				
234					continuous foundation, 3' x 1' h				
235					form & strip	150	sf	\$ 13.08	
236					rebar, 12#/cf	2,700	lbs	\$ 1.66	
237					place concrete	8.33	cy	\$ 194.96	
238					additional rebar to connect to slab fdn wall, 10#/ft	750	lbs	\$ 1.38	
239					footing wall, ave. 6.5' x 1' th.				
240					form & strip	562.50	sf	\$ 13.08	
241					rebar, 12#/cf	3,375	lbs	\$ 1.66	
242					place concrete	10.42	cy	\$ 194.96	
243					slab, 8' x 12"h				
244					form & strip	766	sf	\$ 13.08	
245					rebar, 10#/cf	6,000	lbs	\$ 1.66	
246					place concrete	22.22	cy	\$ 194.96	
247					painted galv. steel guardrail and railing, 2 sides	150	lf	\$ 500.69	
248									
249									

**South Coast Rail  
Rail Side Stations  
Platform - Canopy - Slab - Foundation - Ramps and Stairs  
Study Estimate**

11/2/2016

Line no.		Location	Material	Finish		Qty	Unit	Unit Cost	Option Unit Cost
250	1	Stairs	CIP		Stairs	30	lf		\$ 31,397.00
251					excavation & backfill	19	cy	\$ 32.10	
252					6" gravel base	3	cy	\$ 34.40	
253					30ft wide x ave. (4ft buried) 6.5ft rise x 8ft. overall depth				
254					continuous foundation, 3' x 1' h, 3 ea on stairs + 1 at bottom (4ft below grade)				
255					form & strip	99	sf	\$ 13.08	
256					rebar, 8#/cf	1,188	lbs	\$ 1.66	
257					place concrete	5.50	cy	\$ 194.96	
258					additional rebar to connect to slab fdn wall, 10#/ft	300	lbs	\$ 1.38	
259					footing wall, 3ea ave. 6.5' x 1' th.				
260					form & strip	180	sf	\$ 13.08	
261					rebar, 10#/cf	900	lbs	\$ 1.66	
262					place concrete	3.33	cy	\$ 194.96	
263					stairs, 8' x 12"h				
264					form & strip	480	sf	\$ 13.08	
265					rebar, 10#/cf	800	lbs	\$ 1.66	
266					place concrete	2.96	cy	\$ 220.00	
267					painted galv. steel railing, 5 set	40	lf	\$ 329.31	
268									
269									

**South Coast Rail  
Rail Side Stations  
Platform - Canopy - Slab - Foundation - Ramps and Stairs  
Study Estimate**

Line no.		Location	Material	Finish		Qty	Unit	Unit Cost	Option Unit Cost
<b>270</b>	<b>1</b>	<b>Platform</b>	<b>Galv. steel railing w/pickets</b>		<b>Add to Platform</b>	<b>1</b>	<b>lf</b>		<b>\$ 251.00</b>
271					galv. steel guardrailing on platform	100	lf	\$ 240.54	
272					paint railing	100	lf	\$ 10.91	
273									
<b>274</b>	<b>1</b>	<b>Platform</b>	<b>Stainless steel railing w/pickets</b>		<b>Add to Platform</b>	<b>1</b>	<b>lf</b>		<b>\$ 425.00</b>
275					stainless steel guardrailing on platform	100	lf	\$ 424.89	
276									
277									
278									